

SB220 thru SB2100

1.Feature & Dimensions

- * Plastic package has Underwriters Laboratory Flammability Classification 94V-0
- * Low power loss,high efficiency
- * For use in low voltage high frequency inverters, free wheeling,and polarity protection applications
- * Guarding for over voltage protection
- * High temperature soldering guaranteed: 260°C/10 seconds at terminals

2.Mechanical Data

Case: JEDEC DO-15, molded plastic over glass body

Terminals: Plated axial leads, solderable per MIL-STD-750, Method 2026

Polarity: Color band denotes cathode end

Mounting Position: Any

Weight: 0.015 oz., 0.40 g

Handling precautin:None

3.Electrical Characteristic

Maximum Ratings & Thermal Characteristics Ratings at 25°C ambient temperature unless otherwise specified.

Parameter Symbol	symbol	SB220	SB230	SB240	SB250	SB260	SB280	SB2100	Unit
Maximum repetitive peak reverse voltage	V_{RRM}	20	30	40	50	60	80	100	V
Maximum RMS voltage	V_{RMS}	14	21	28	35	42	56	70	V
Maximum DC blocking voltage	V_{DC}	20	30	40	50	60	80	100	V
Maximum average forward rectified current 0.375" (9.5mm) lead length (See fig. 1)	$I_{F(AV)}$	2.0							A
Peak forward surge current 8.3ms single half sine-wave superimposed on rated load (JEDEC Method)	I_{FSM}	60							A
Typical thermal resistance (Note 1)	$R_{\theta JA}$	50							°C/W
Operating junction and storage temperature range	T_J, T_{STG}	-40 to +125							°C

Schottky Barrier Rectifiers

Reverse Voltage 20 to 100V

Forward Current 2.0A

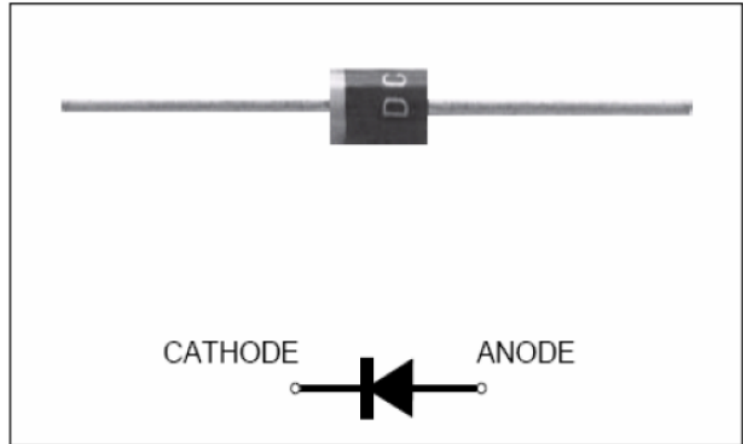

We declare that the material of product compliance with RoHS requirements.

Electrical Characteristics Ratings at 25°C ambient temperature unless otherwise specified.

Parameter Symbol	symbol	SB220	SB230	SB240	SB250	SB260	SB280	SB2100	Unit
Maximum instantaneous forward voltage at 2.0A	V_F	0.50			0.70		0.84		V
Maximum DC reverse current $T_A = 25^\circ\text{C}$ at rated DC blocking voltage $T_A = 100^\circ\text{C}$	I_R	0.5 20							mA
Typical junction capacitance at 4.0V, 1MHz	C_J	170							PF

NOTES:

1. Thermal resistance from junction to ambient at 0.375" (9.5mm) lead length, P.C.B. mounted

4. Characteristic Curves (TA = 25°C unless otherwise noted)

Fig. 1 - Forward Current Derating Curve

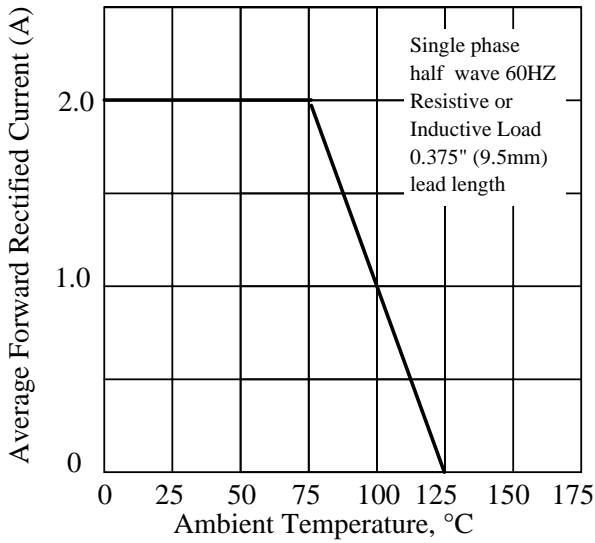

Fig. 2 - Maximum Non-repetitive Peak Forward Surge Current

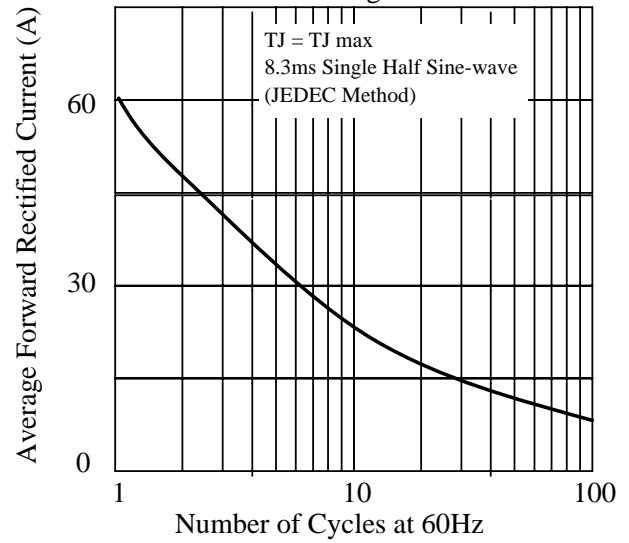

Fig. 3. - Typical Instantaneous Forward Characteristics

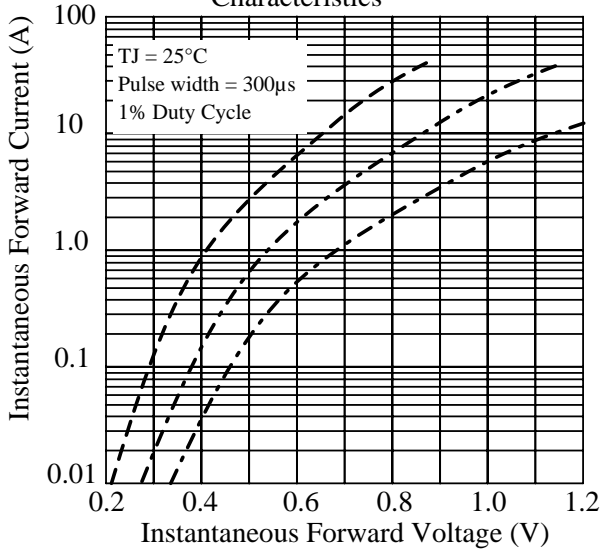

Fig 4. - Typical Reverse Characteristics

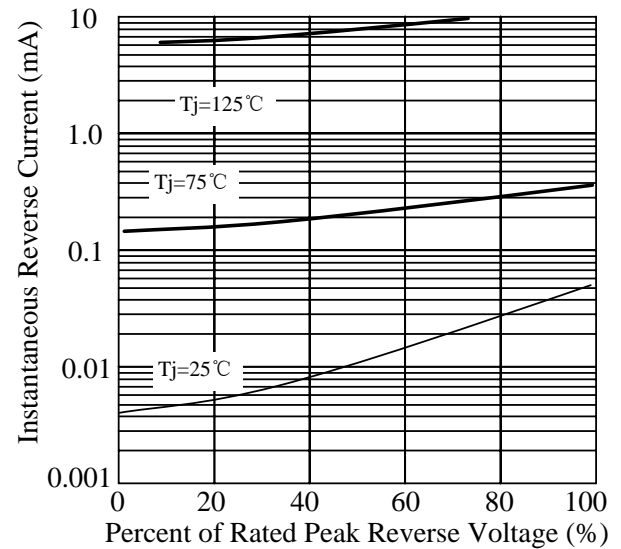

Fig 5. - typical transient thermal impedance

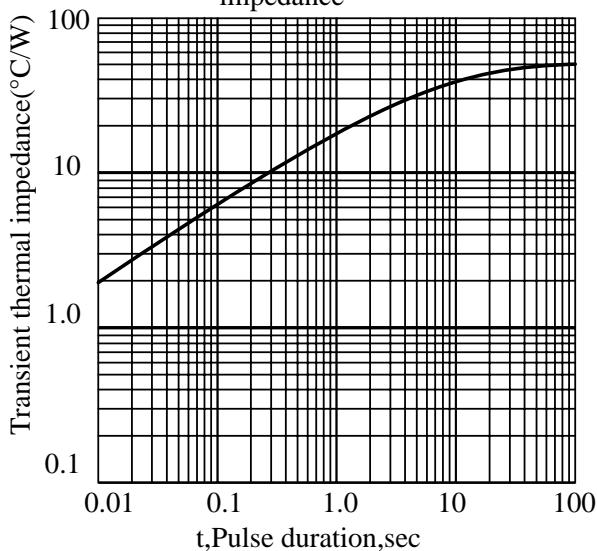
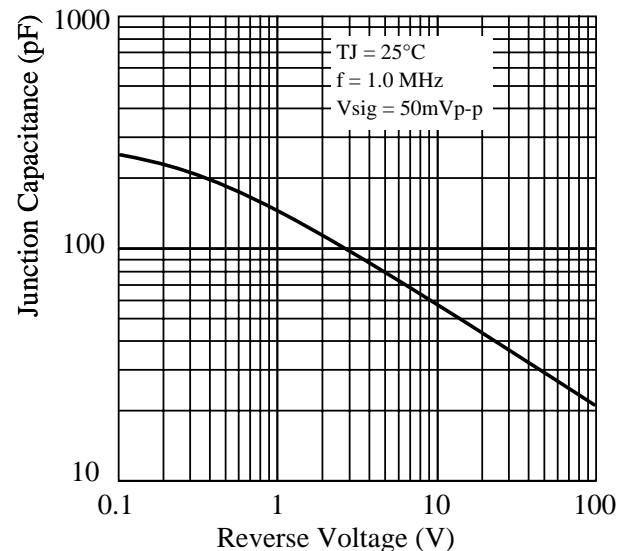
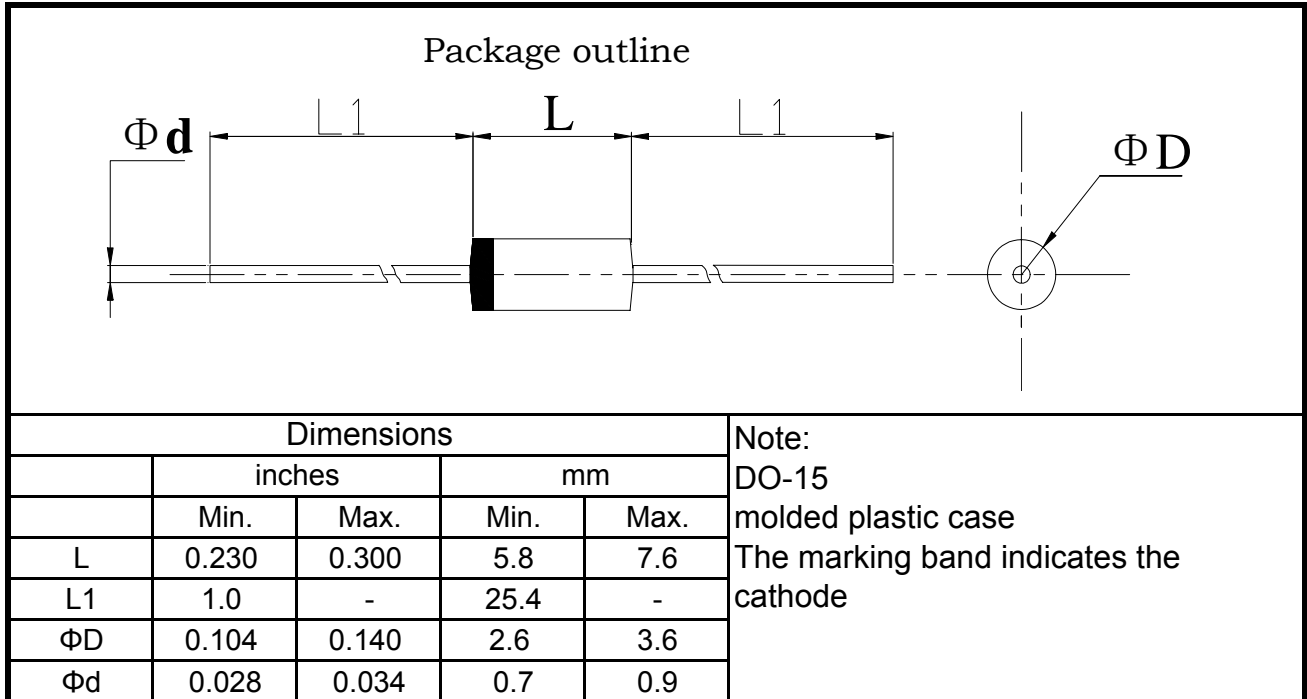

Fig 6. - Typical Junction Capacitance



5.Package Dimensions in inches and (millimeters)

Packing Of Plastic-Sealed Axial Lead Diodes

1. 卷盘/Reel Packing (52mm)

Unit:mm

A: 卷盘规格/Reel spec.

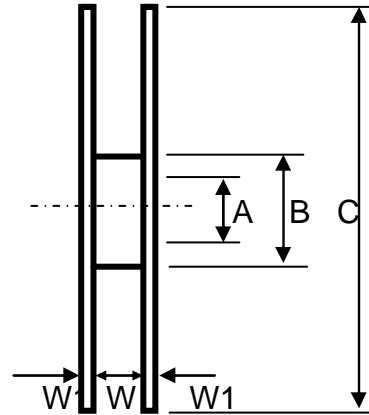
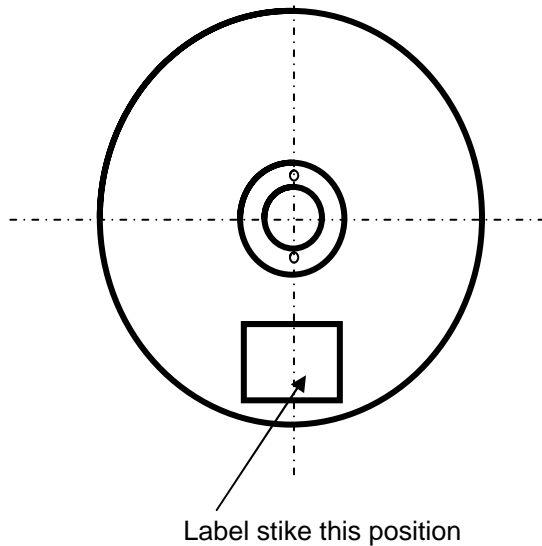

Item	Symbol	Dimension
Dimeter	A	76.4 ± 0.1
	B	82.5 ± 0.2
	C	330 ± 0.5
Width	W	72 ± 0.2
Thickness	W1	3 ± 0.2

B: 外箱规格/Outer Box Specification

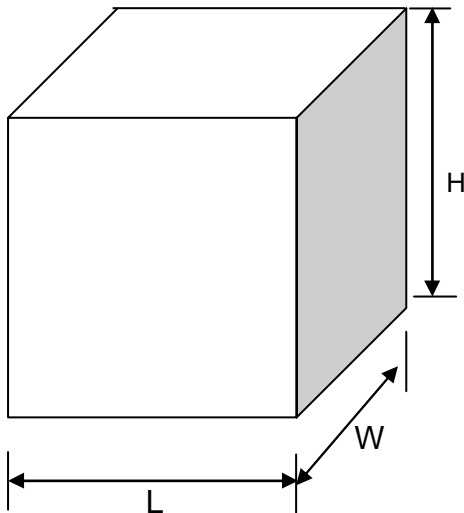

Item	Symbol	Dimension
Size	L	350 ± 2
	W	350 ± 2
	H	340 ± 4

按以上包装方式: (As per the above spec)

	外型/Outside		
	DO-41 & A-405	DO-15	DO-201AD
Q'ty/Taping	5K	4K	1.4K
Q'ty/Packing Case	20K	16K	5.6K

2. 弹带盒装/Ammo Packing

Unit:mm

A: 弹带盒规格/Ammo Box Spec.



Item	Symbol	Dimension	Notes
Box's Size	L	260±2	52mm TYPE
	W	76±2	
	H	100±4	
	L	250±3	26mm TYPE
	W	45±3	
	H	95±5	

B: 外箱规格/Outer Box Specification

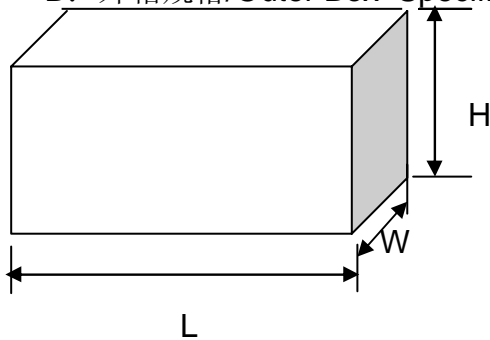

Item	Symbol	Dimension	Notes
Case's Size	L	430±2	52mm TYPE
	W	280±2	
	H	225±4	
	L	435±3	26mm TYPE
	W	280±3	
	H	295±5	

按以上包装方式: (As per the above spec)

	外型/Outside		
	A-405 & DO-41 & R-1	DO-15	DO-201AD
Q'ty/Taping	3K	2K	0.8K
Q'ty/Packing Case 26mm/TYPE	30K	20K	7.2K
Q'ty/Packing Case 52mm/TYPE	60K	40K	14.4K

3. 散装/Bulk Packing

A. 包装盒尺寸/Box Dimension

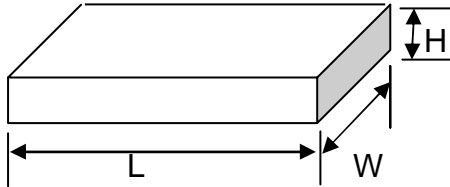

(DO-41&DO-15)

Item	Symbol	Dimension
Box's Size	L	200±2
	W	84±2
	H	21±2

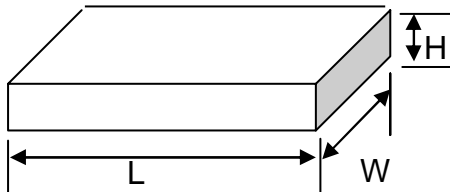

(DO-201AD)

Item	Symbol	Dimension
Box's Size	L	200±2
	W	84±2
	H	29±2

B: 外箱规格/Outer Box Specification

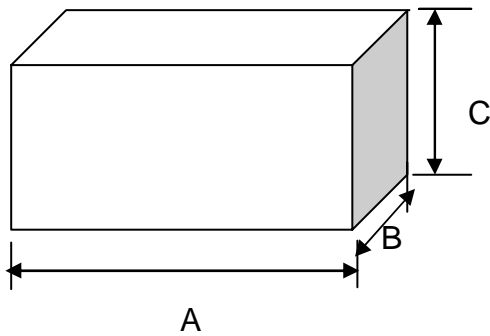

Item	Symbol	Dimension
Case's Size	L	465±2
	W	225±2
	H	260±4

按以上包装方式: (As per the above spec)

	外型/Outside		
	DO-41&A-405&R-1	DO-15	DO-201AD
Q'ty/Taping	1K	0.5K	0.3K
Q'ty/Packing Case	50K	25K	12K

4. 编带图形及规格/Taping Specification

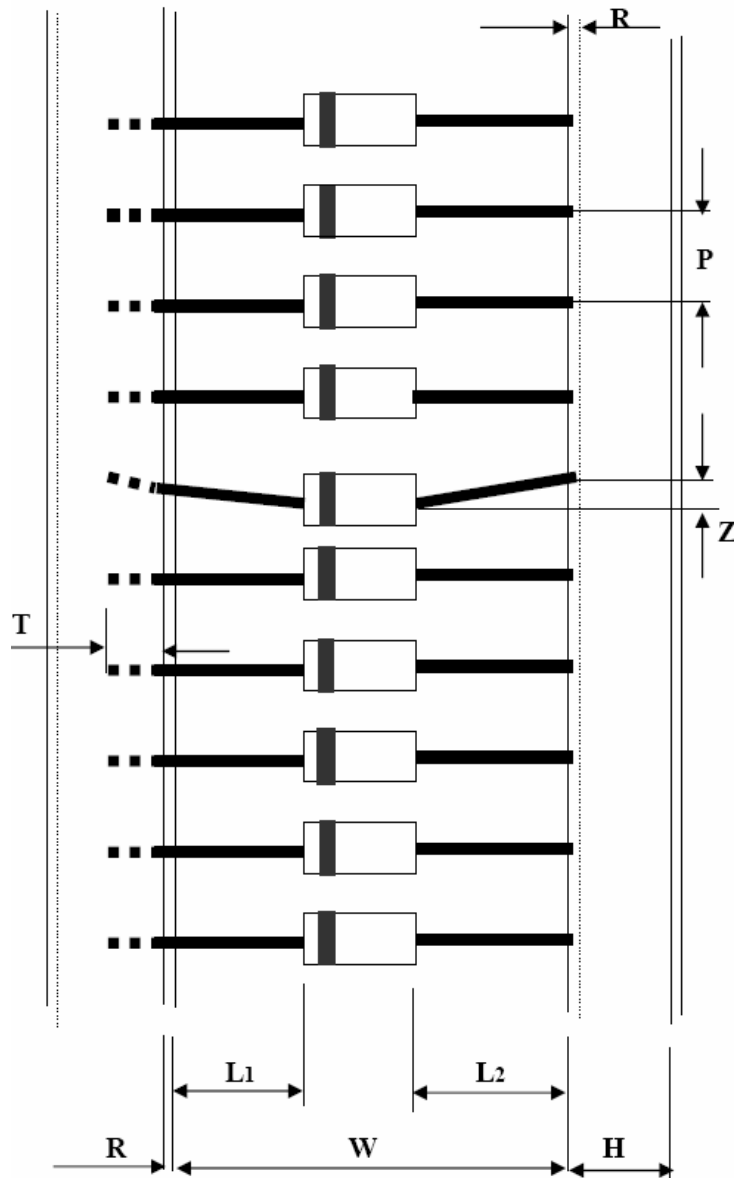

Unit:mm

尺寸代号	编带尺寸/Tape Dimension		
Dimension Code	26/tape	52/tape	52/tape#
W	26 0.0/+1.6	52 -1.0/+2.0	52 -1.0/+2.0
P	5±0.5	5±0.5	10±0.5
L1-L2	<1.0	<1.2	<1.2
H	6±1.0	6±1.0	6±1.0
Z	<1.2	<1.2	<1.2
R	<1.0	<1.0	<1.0
T	>3.2	>3.2	>3.2

注: 52编带# 为DO-201AD编带规格

Remark: 52 tape# is DO-201AD taping spec.