



## SB2202

### PNP EPITAXIAL SILICON TRANSISTOR

## MEDIUM POWER LOW VOLTAGE TRANSISTOR

### ■ DESCRIPTION

The UTC **SB2202** is a medium power low voltage transistor, designed for audio power amplifier, DC-DC converter and voltage regulator.

### ■ FEATURES

- \*High current output up to 3A
- \*Low saturation voltage

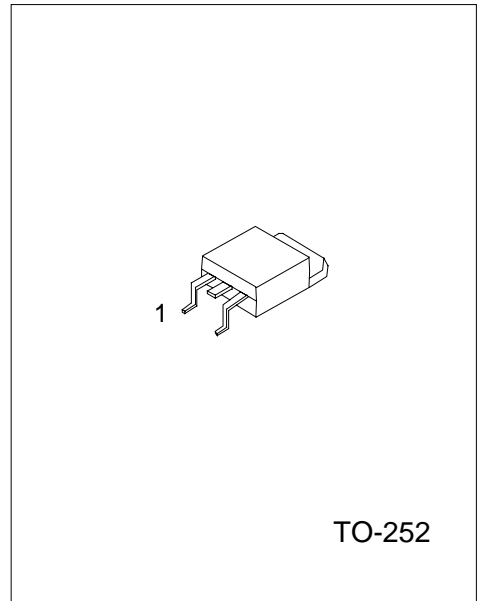

\* Pb-free plating product number: SB2202L

### ■ PIN CONFIGURATION

PIN NO.	PIN NAME
1	Base
2	Collector
3	Emitter

### ■ ORDERING INFORMATION

Order Number		Package	Packing
Normal	Lead free		
SB2202-TN3-R	SB2202L-TN3-R	TO-252	Tape & Reel
SB2202-TN3-T	SB2202L-TN3-T	TO-252	Tube

■ ABSOLUTE MAXIMUM RATINGS (Ta=25°C , unless otherwise specified )

PARAMETER		SYMBOL	RATINGS	UNIT
Collector-Base Voltage		$V_{CBO}$	-40	V
Collector-Emitter Voltage		$V_{CEO}$	-30	V
Emitter-Base Voltage		$V_{EBO}$	-5	V
Base Current		$I_B$	-0.6	A
Collector Current	DC	$I_C$	-3	A
	PULSE	$I_{CM}$	-7	
Collector Dissipation	Tc=25°C	Pc	10	W
	Ta=25°C		1	
Junction Temperature		$T_J$	+150	°C
Storage Temperature		$T_{STG}$	-40 ~ +150	°C

■ ELECTRICAL CHARACTERISTICS (Ta=25°C, unless otherwise specified.)

PARAMETER	SYMBOL	TEST CONDITIONS	MIN	TYP	MAX	UNIT
Collector-Emitter Saturation Voltage	$V_{CE(sat)}$	$I_C = -2A, I_B = -0.2A$		-0.3	-0.5	V
Base-Emitter Saturation Voltage	$V_{BE(sat)}$	$I_C = -2A, I_B = -0.2A$		-1.0	-2.0	V
Collector Cut-Off Current	$I_{CBO}$	$V_{CB} = -30V, I_E = 0$			1	mA
Emitter Cut-Off Current	$I_{EBO}$	$V_{EB} = -3V, I_C = 0$			1	mA
DC Current Gain(Note 1)	$h_{FE1}$	$V_{CE} = -2V, I_C = -20mA$	30	200	400	
	$h_{FE2}$	$V_{CE} = -2V, I_C = -1A$	100			
Current Gain Bandwidth Product	$f_T$	$V_{CE} = -5V, I_C = -0.1A$		80		MHz
Output Capacitance	$C_{ob}$	$V_{CB} = -10V, I_E = 0, f = 1MHz$		45		pF

Note 1: Pulse test: PW<300μs, Duty Cycle<2%

■ CLASSIFICATION OF hFE2

RANK	Q	P	E
RANGE	100 ~ 200	160 ~ 320	200 ~ 400

## TYPICAL CHARACTERISTICS

Static characteristics

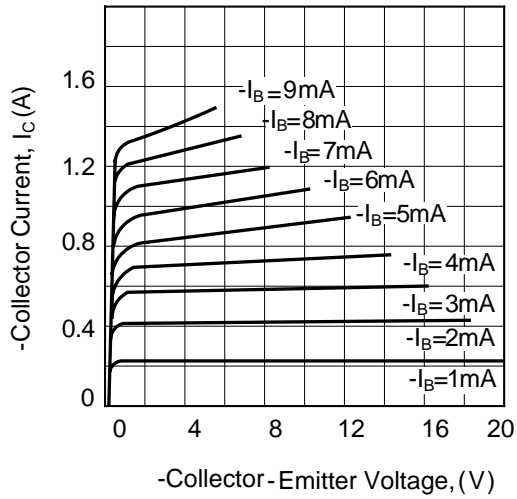

Derating curve of safe operating areas

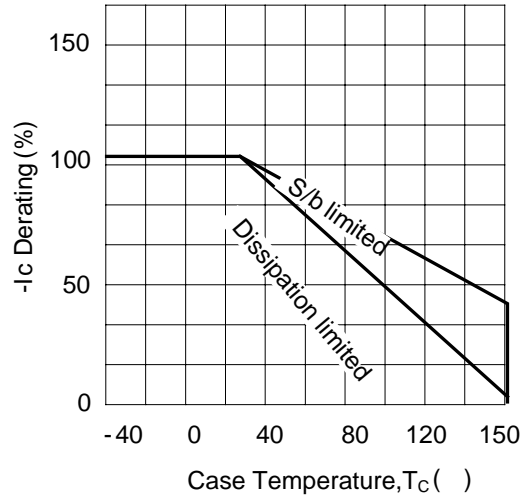

Power derating

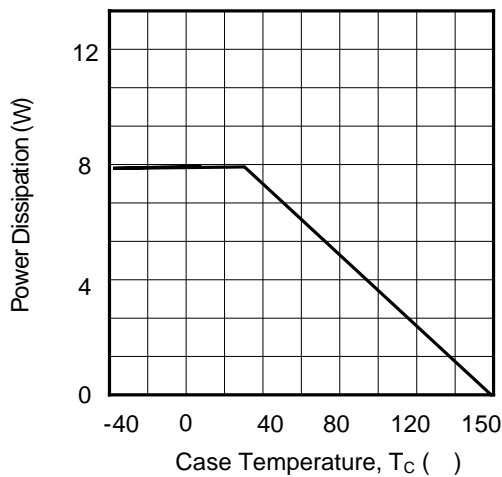

Collector output capacitance

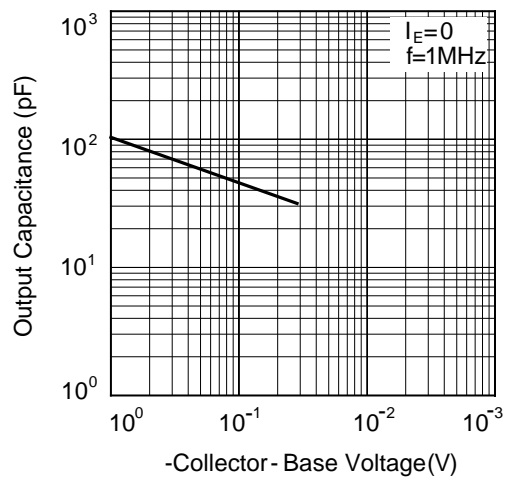

Current gain-bandwidth product

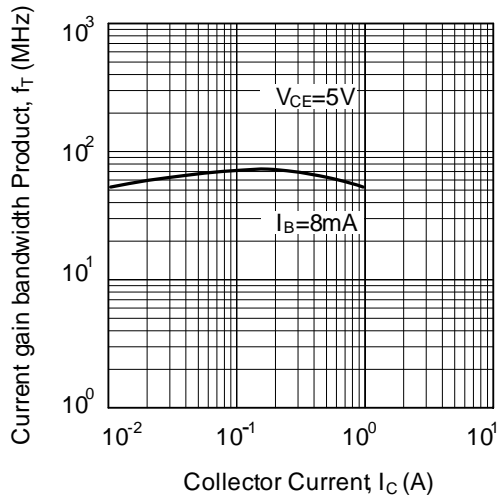

Safe operating area

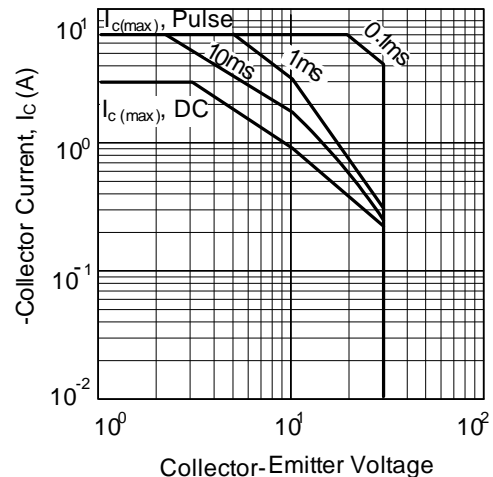

■ TYPICAL CHARACTERISTICS (cont.)

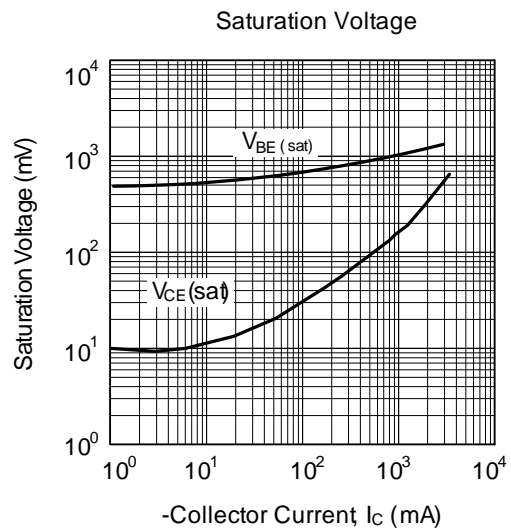
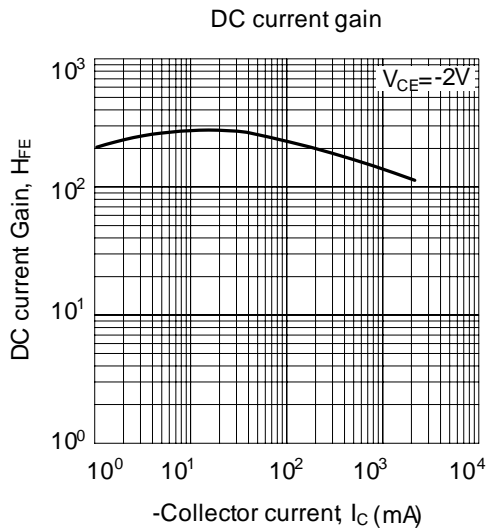

UTC assumes no responsibility for equipment failures that result from using products at values that exceed, even momentarily, rated values (such as maximum ratings, operating condition ranges, or other parameters) listed in products specifications of any and all UTC products described or contained herein. UTC products are not designed for use in life support appliances, devices or systems where malfunction of these products can be reasonably expected to result in personal injury. Reproduction in whole or in part is prohibited without the prior written consent of the copyright owner. The information presented in this document does not form part of any quotation or contract, is believed to be accurate and reliable and may be changed without notice.