

Silicon-Based Technology

Ultra High Speed and Low Power Memory

SB61L256B

32,768 x 8-Bits

STATIC CMOS RAM

PRELIMINARY

Description:

The SB61L256B series products are 32,768-words by 8-bits static RAMs fabricated with advanced 8" wafer submicron CMOS technology. Using unique CMOS peripheral circuits and special poly-load 4-transistor memory cells, the SB61L256B series products exhibit very high-speed performance with single +3.3-volt power supply while requiring very low power and no clock or refreshing to operate. The SB61L256B is packed in a standard 28-pin 300mil SOJ.

Features:

- 32,768-word x 8-bit organization
- Single +3.3-volt power supply
- Fully static operation — no clock or refreshing required
- LVTTL-compatible inputs and outputs
- Common I/O capability
- Low power consumption
 - Active: 130/120/110 mA (Max.)
 - Standby: 2 mA
- Very high speed access: 6.5/7/8 ns (Max.)
- 28-pin plastic 300 mil SOJ package
- Output Enable ($\overline{\text{OE}}$) available for very fast access

Ordering Information:

Part Number	Package	Word Organization	Access Time ns(Max.)	Supply Voltage (Typ.)	Supply Current mA (Max.)	
					Operating	Standby
SB61L256B-6.5	28-Pin Plastic SOJ (300 mil)	32Kx 8 bits	6.5	3.3V± 5%	130	2
SB61L256B-7			7		120	
SB61L256B-8			8		110	

The information in this document is subject to change without notice



Silicon-Based Technology Corporation

1F, No.23, R&D Rd.I, Science-Based Industrial Park, Hsinchu, Taiwan, R.O.C.

Tel : 886-35-777897

Fax : 886-35-779832



Pin Configuration: 28-Pin 300 mil SOJ

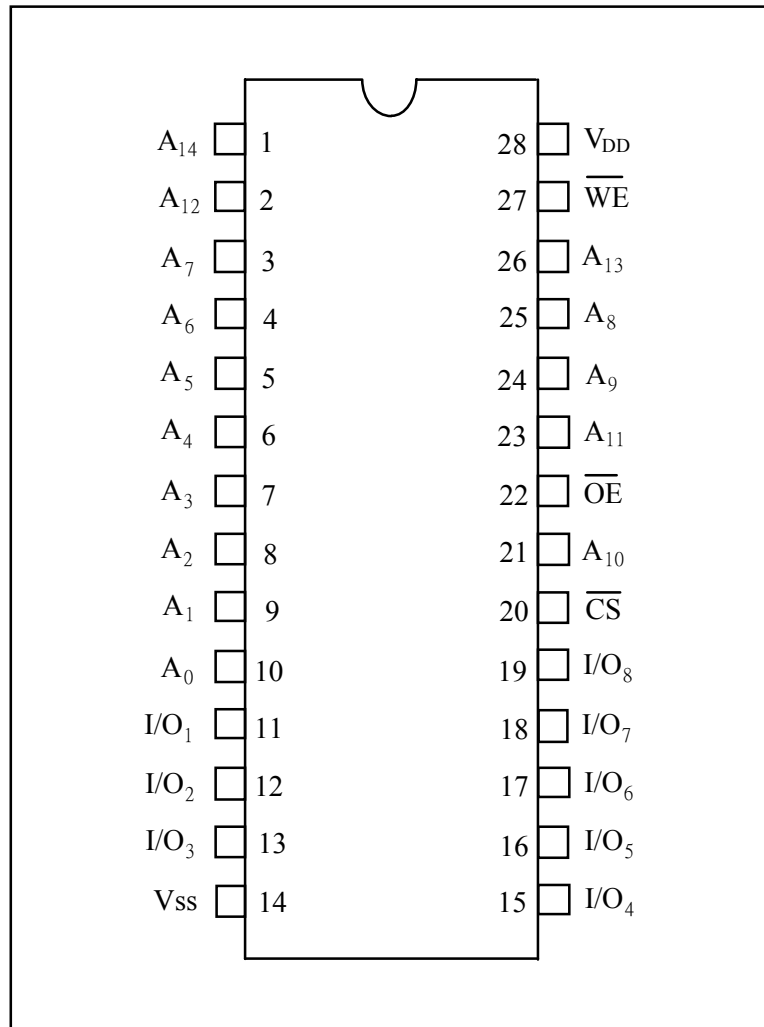

Symbols	Functions
$A_0 \sim A_{14}$	Address Inputs
$I/O_1 \sim I/O_8$	Data Inputs/Outputs
\overline{CS}	Chip Select Input
\overline{WE}	Write Enable Input
\overline{OE}	Output Enable Input
V_{DD}	Power Supply
V_{SS}	Ground



Block Diagram:

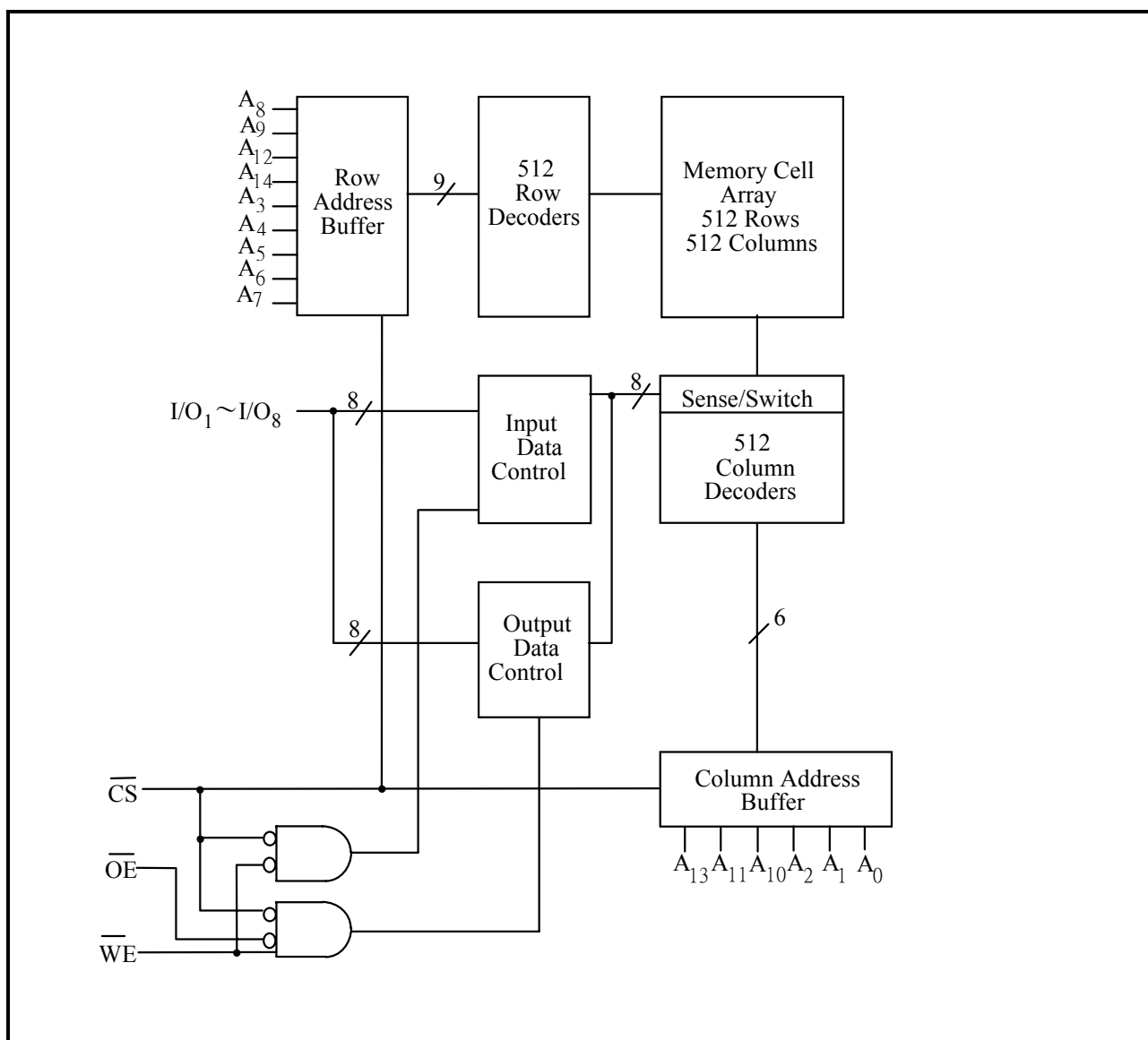

Truth Table:

$\overline{\text{CS}}$	$\overline{\text{OE}}$	$\overline{\text{WE}}$	Mode	I/O ₁ ~I/O ₈	V _{DD} Current
H	X	X	Not Selected	High Z	I _{SB} , I _{SB1}
L	H	H	Output Disable	High Z	I _{DD}
L	L	H	Read	Data Out	I _{DD}
L	X	L	Write	Data In	I _{DD}



DC Characteristics:

Absolute Maximum Ratings

Parameters	Rating	Unit
Supply Voltage to V _{SS}	-0.5 to +4.6	V
Input/Output to V _{SS}	-0.5 to V _{DD} +0.5	V
Allowable Power Dissipation	1.0	W
Storage Temperature	-65 to +150	°C
Operating Temperature	0 to +70	°C

Operating Characteristics:

(V_{DD} = 3.3V ± 5%, V_{SS} = 0V, T_a = 0 to 70°C)

Parameters	Symbols	Test Conditions	Min.	Typ.	Max.	Unit	
Input Low Voltage	V _{IL}	-	-0.3	-	+0.8	V	
Input High Voltage	V _{IH}	-	+2.1	-	V _{DD} +0.3	V	
Input Leakage Current	I _{LI}	V _{IN} = V _{SS} to V _{DD}	-10	-	+10	μA	
Output Leakage Current	I _{LO}	V _{I/O} = V _{SS} to V _{DD} , \overline{CS} = V _{IH} or \overline{OE} = V _{IH} or \overline{WE} = V _{IL}	-10	-	+10	μA	
Output Low Voltage	V _{OL}	I _{OL} = +8.0mA	-	-	0.4	V	
Output High Voltage	V _{OH}	I _{OH} = -4.0mA	2.4	-	-	V	
Operating Power Supply Current	I _{DD}	\overline{CS} = V _{IL} , I/O = 0 mA	6.5	-	-	130	mA
		Cycle = MIN	7	-	-	120	mA
		Duty = 100%	8	-	-	110	mA
Standby Power Supply Current	I _{SB}	\overline{CS} = V _{IH} , Cycle = MIN Duty = 100%	-	-	15	mA	
	I _{SB1}	$\overline{CS} \geq V_{DD} - 0.2V$	-	-	2	mA	

Note: Typical characteristics are measured at V_{DD} = 3.3V, T_a = 25°C



AC Characteristics:

Capacitances

(V_{DD} = 3.3V, T_a = 25°C, f = 1 MHz)

Parameters	Symbols	Conditions	Max.	Unit
Input Capacitance	C _{IN}	V _{IN} = 0V	6	pF
Input/Output Capacitance	C _{I/O}	V _{OUT} = 0V	8	pF

Note: These parameters are sampled but not 100% tested.

AC Test Conditions

Parameters	Conditions
Input Pulse Levels	0V to 3V
Input Rise and Fall Times	3 ns
Input and Output Timing Reference Level	1.5V
Output Load	C _L = 30 pF, I _{OH} /I _{OL} = -4 mA/8 mA

AC Test Loads and Waveforms

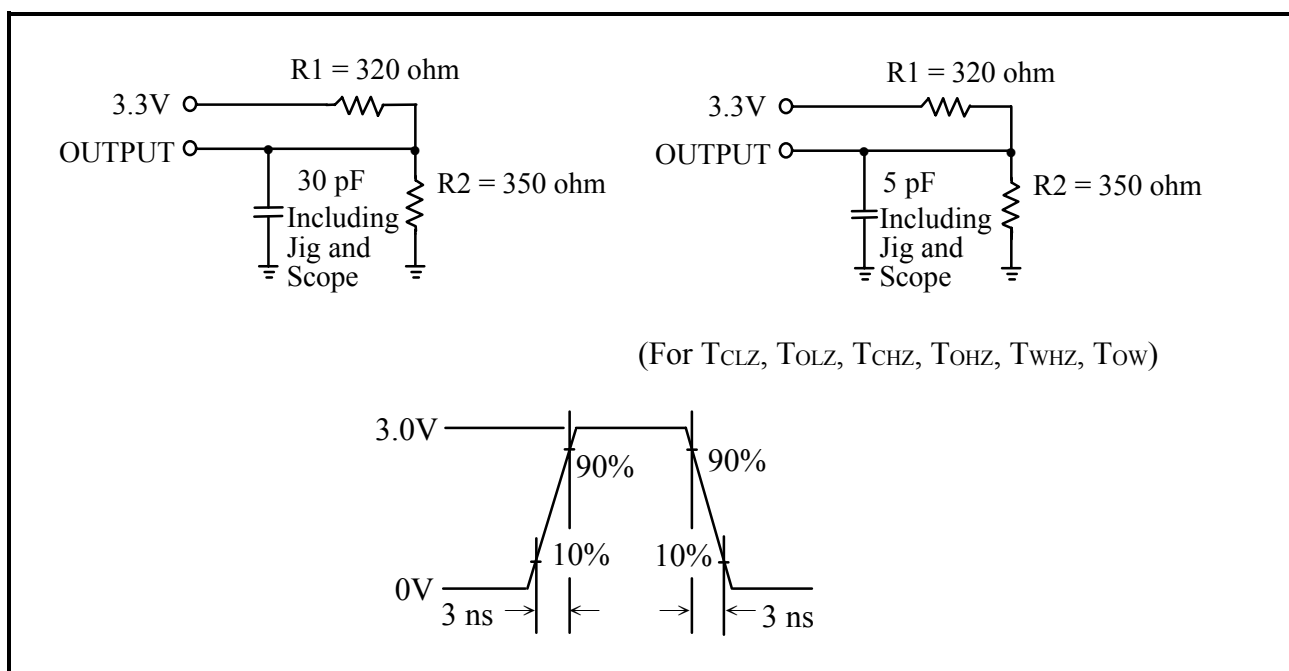



AC Performances:

($V_{DD} = 3.3V \pm 5\%$, $V_{SS} = 0V$, $T_a = 0$ to $70^{\circ}C$)

(1) Read Cycle

Parameters	Symbols	SB61L256B-6.5		SB61L256B-7		SB61L256B-8		Unit
		Min.	Max.	Min.	Max.	Min.	Max.	
Read Cycle Time	T_{RC}	6.5	-	7	-	8	-	ns
Address Access Time	T_{AA}	-	6	-	7	-	8	ns
Chip Select Access Time	T_{ACS}	-	6	-	7	-	8	ns
Output Enable to Output Valid	T_{AOE}	-	4	-	4.5	-	5	ns
Chip Selection to Output in Low Z	T_{CLZ}^*	3	-	3	-	3	-	ns
Output Enable to Output in Low Z	T_{OLZ}^*	0	-	0	-	0	-	ns
Chip Deselection to Output in High Z	T_{CHZ}^*	-	3	-	3.5	-	4	ns
Output Disable to Output in High Z	T_{OHZ}^*	-	3	-	3.5	-	4	ns
Output Hold from Address Change	T_{OH}	3	-	3	-	3	-	ns

*These parameters are sampled but not 100% tested

(2) Write Cycle

Parameters	Symbols	SB61L256B-6.5		SB61L256B-7		SB61L256B-8		Unit
		Min.	Max.	Min.	Max.	Min.	Max.	
Write Cycle Time	T_{WC}	6.5	-	7	-	8	-	ns
Chip Selection to End of Write	T_{CW}	4	-	5	-	6	-	ns
Address Valid to End of Write	T_{AW}	4	-	5	-	6	-	ns
Address Setup Time	T_{AS}	0	-	0	-	0	-	ns
Write Pulse Width	T_{WP}	4	-	5	-	6	-	ns
Write Recovery Time	T_{WR}	0	-	0	-	0	-	ns
Data Valid to End of Write	T_{DW}	4	-	4.5	-	5	-	ns
Data Hold from End of Write	T_{DH}	0	-	0	-	0	-	ns
Write to Output in High Z	T_{WHZ}^*	-	3	-	3.5	-	4	ns
Output Disable to Output in High Z	T_{OHZ}^*	-	3	-	3.5	-	4	ns
Output Active from End of Write	T_{OW}	0	-	0	-	0	-	ns

* These parameters are sampled but not 100% tested

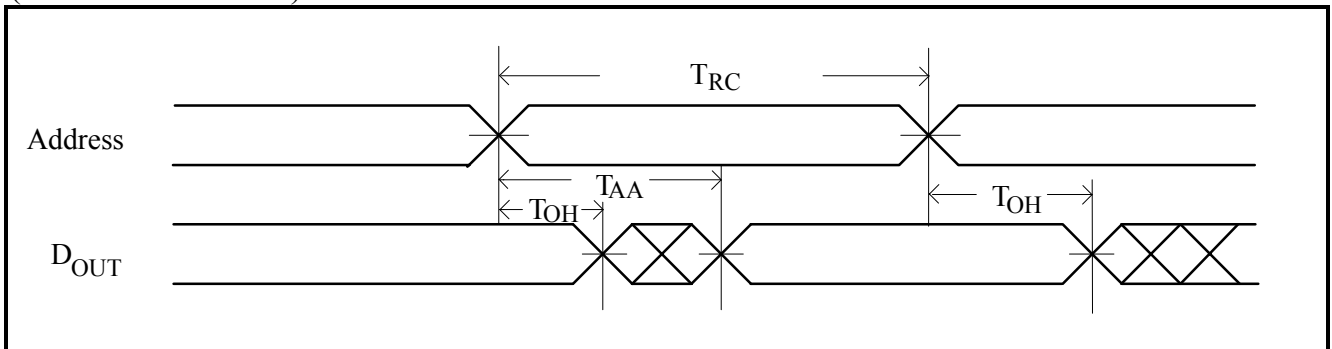
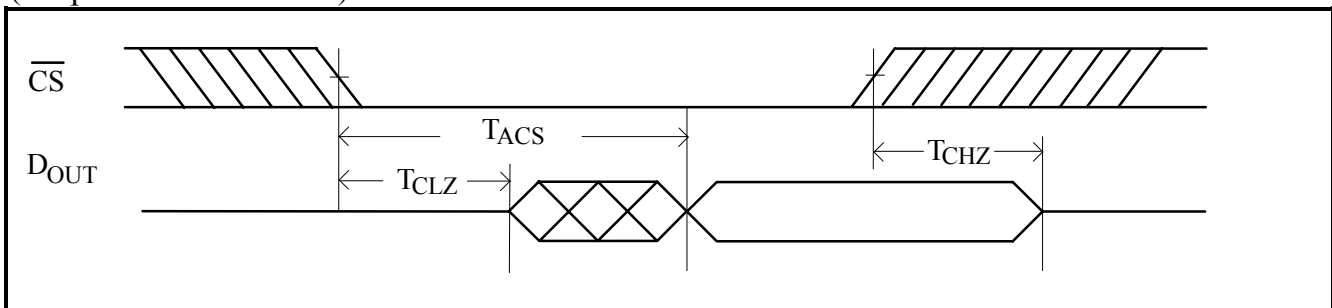
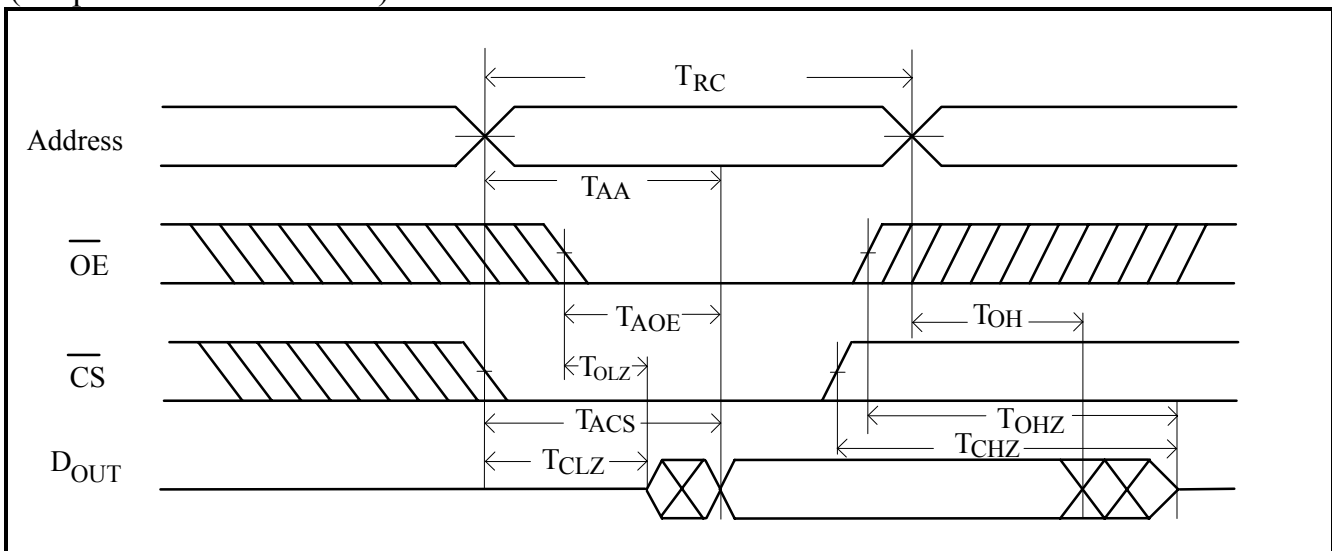

Timing Waveforms

Read Cycle 1
(Address Controlled)Read Cycle 2
(Chip Select Controlled)Read Cycle 3
(Output Enable Controlled)



Write Cycle 1 (\overline{OE} Clock)

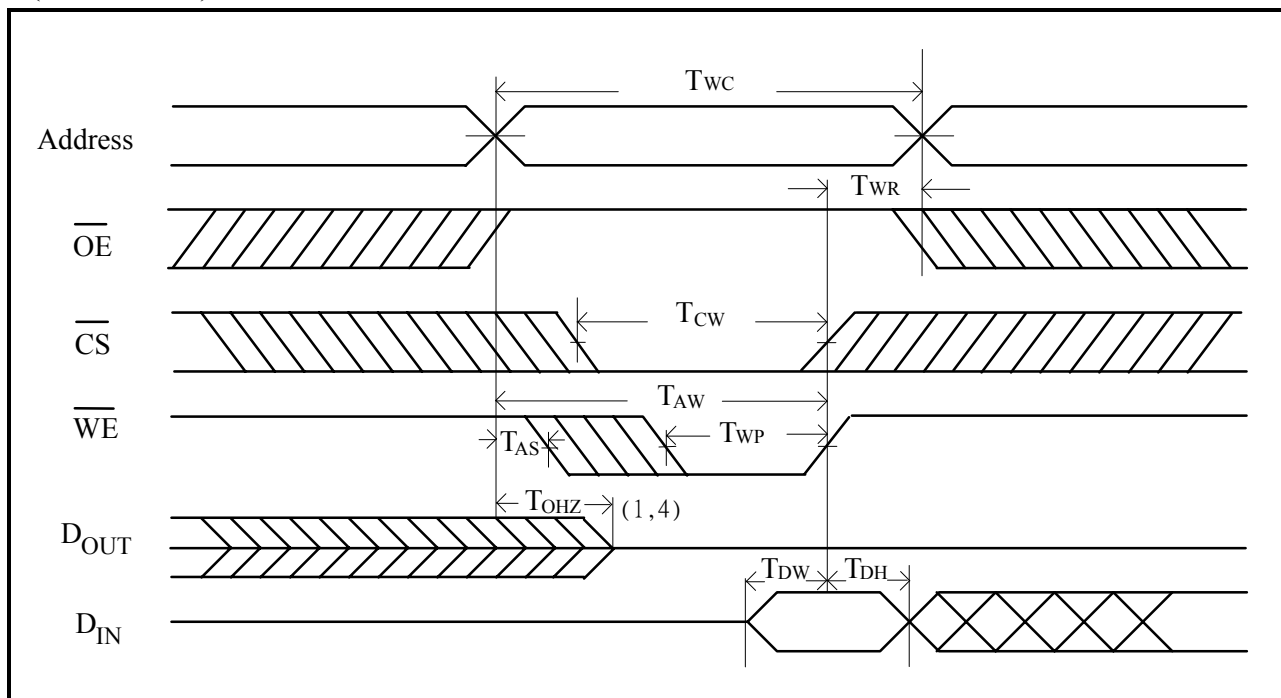

Write Cycle 2 ($\overline{OE} = V_{IL}$ Fixed)

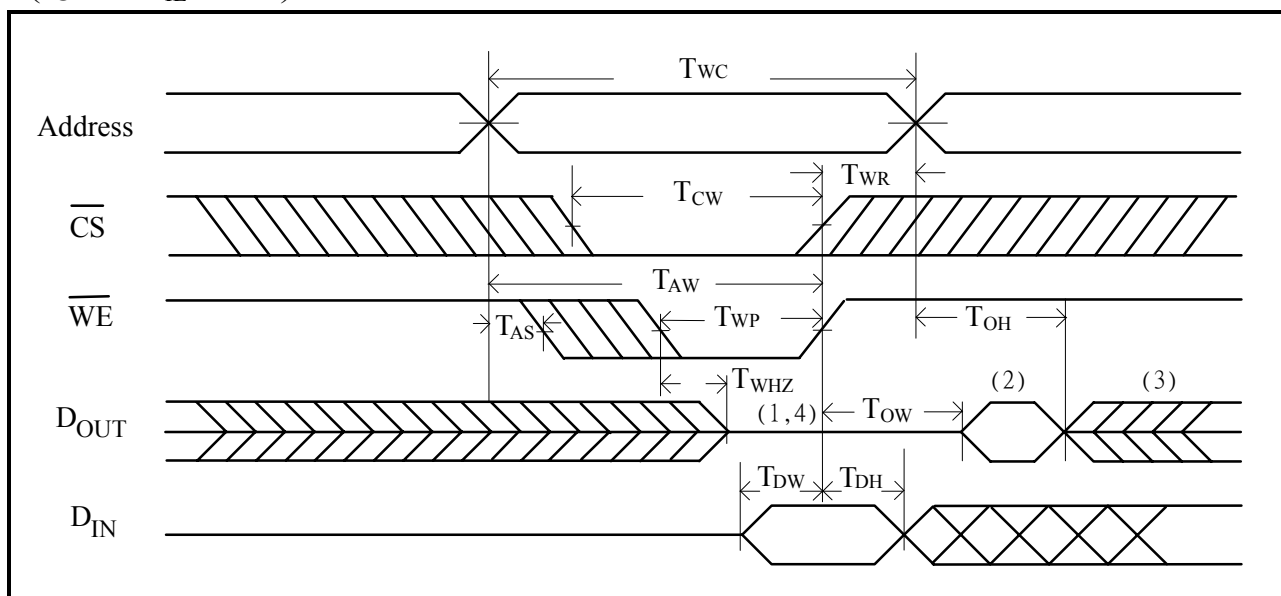

Notes:

1. During this period, I/O pins are in the output state, so input signals of opposite phase to the outputs should not be applied.
2. The data output from D_{OUT} are the same as the data written to D_{IN} during the write cycle.
3. D_{OUT} provides the read data for the next address.
4. Transition is measured $\pm 500\text{mV}$ from steady state with $C_L = 5\text{pF}$. This parameter is guaranteed but not 100% tested.