

**Descriptions**

- General purpose application
- Switching application

**Features**

- High voltage :  $V_{CE0}=30V$
- Complementary pair with SBC558

**Ordering Information**

Type NO.	Marking	Package Code
SBC548	SBC548	TO-92

**Outline Dimensions**

unit : mm

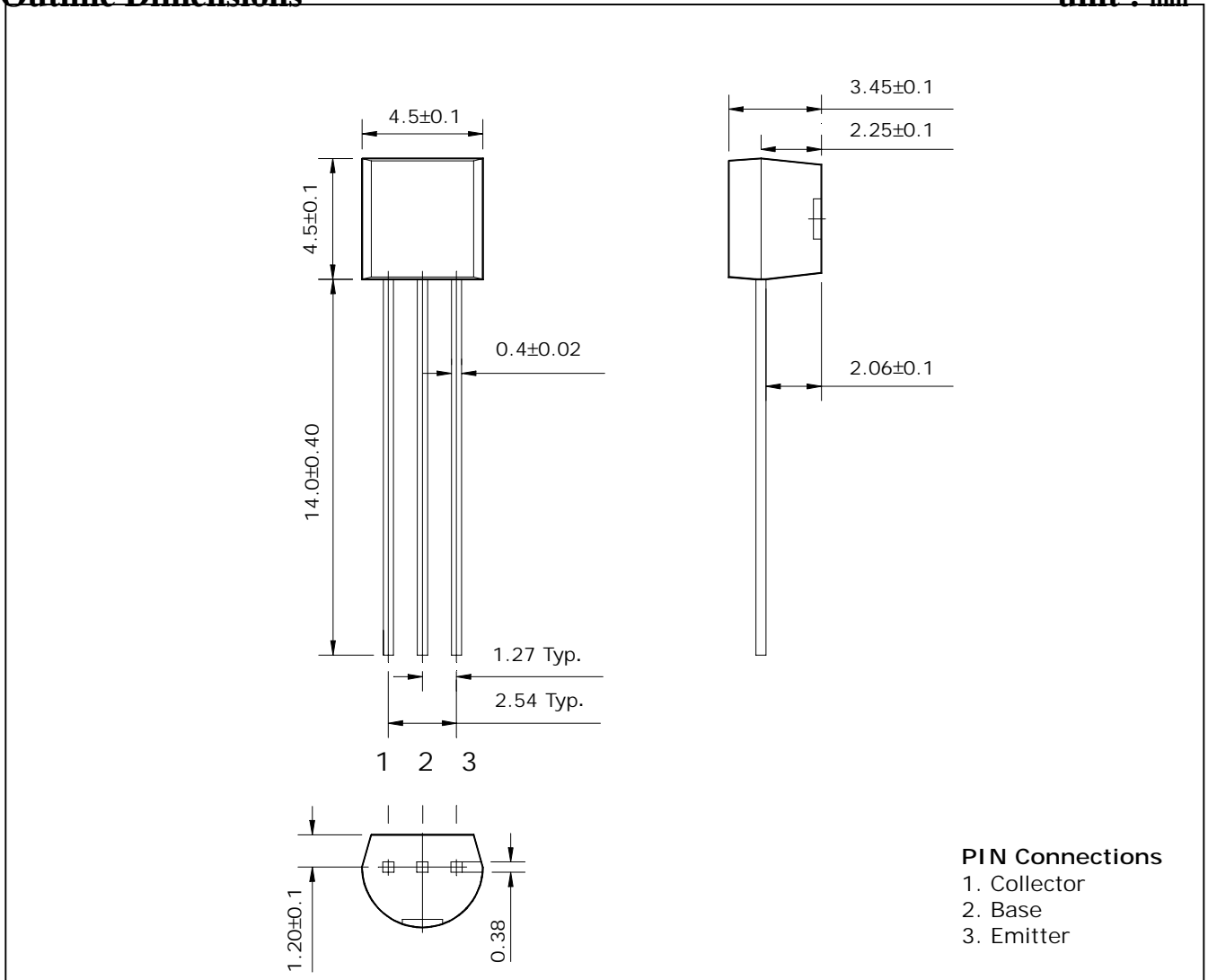

**Absolute maximum ratings**

(Ta=25°C)

Characteristic	Symbol	Ratings	Unit
Collector-Base voltage	$V_{CBO}$	30	V
Collector-Emitter voltage	$V_{CEO}$	30	V
Emitter-Base voltage	$V_{EBO}$	5	V
Collector current	$I_C$	100	mA
Collector dissipation	$P_C$	625	mW
Junction temperature	$T_J$	150	°C
Storage temperature	$T_{stg}$	-55 ~ 150	°C

**Electrical Characteristics**

(Ta=25°C)

Characteristic	Symbol	Test Condition	Min.	Typ.	Max.	Unit
Collector-Emitter breakdown voltage	$BV_{CEO}$	$I_C=1mA, I_B=0$	30	-	-	V
Base-Emitter turn on voltage	$V_{BE(ON)}$	$V_{CE}=5V, I_C=2mA$	550	-	700	mV
Base-Emitter saturation voltage	$V_{BE(sat)}$	$I_C=100mA, I_B=5mA$	-	900	-	mV
Collector-Emitter saturation voltage	$V_{CE(sat)}$	$I_C=100mA, I_B=5mA$	-	-	600	mV
Collector cut-off current	$I_{CBO}$	$V_{CB}=35V, I_E=0$	-	-	15	nA
DC current gain	$h_{FE}^*$	$V_{CE}=5V, I_C=2mA$	110	-	800	-
Transition frequency	$f_T$	$V_{CE}=5V, I_C=10mA$	-	150	-	MHz
Collector output capacitance	$C_{ob}$	$V_{CB}=10V, I_E=0, f=1MHz$	-	-	4.5	pF
Noise figure	NF	$V_{CE}=5V, I_C=200\mu A, f=1KHz, R_g=2K\Omega$	-	-	10	dB

\* :  $h_{FE}$  rank / A : 110 ~ 220, B : 200 ~ 450, C : 420 ~ 800

## Electrical Characteristic Curves

Fig. 1  $P_C$ - $T_a$

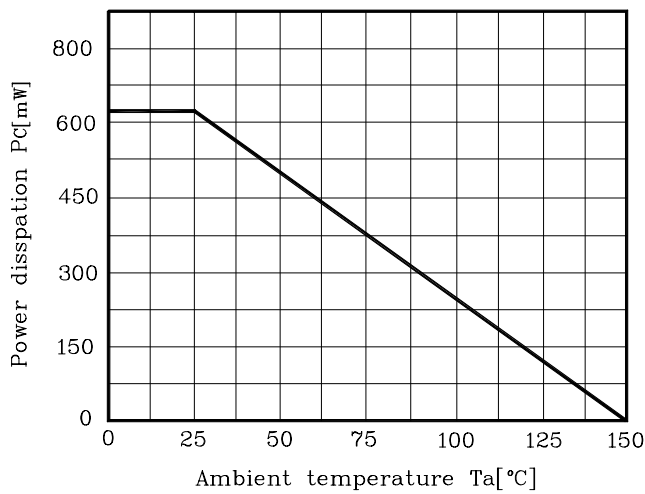

Fig. 2  $I_C$  - $V_{BE}$

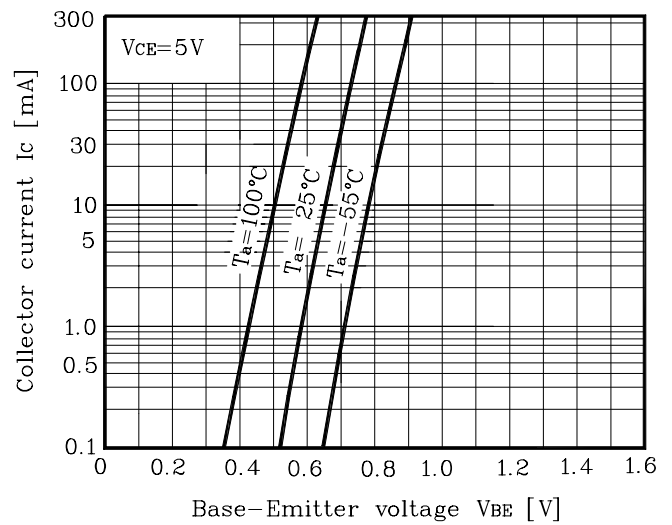

Fig. 3  $I_C$  - $V_{CE}$

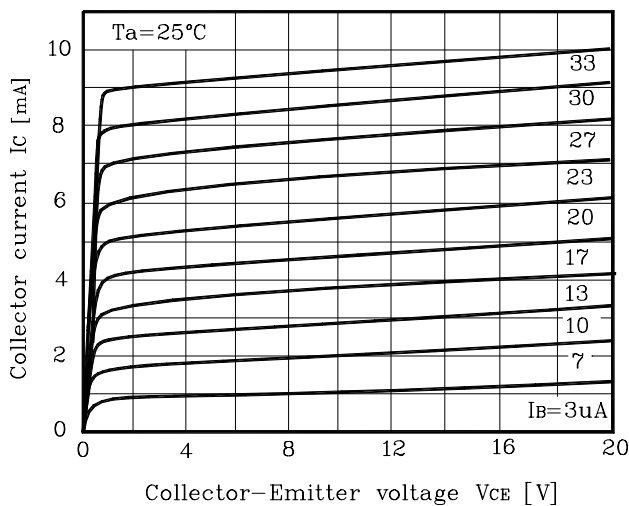

Fig. 4  $h_{FE}$  - $I_C$

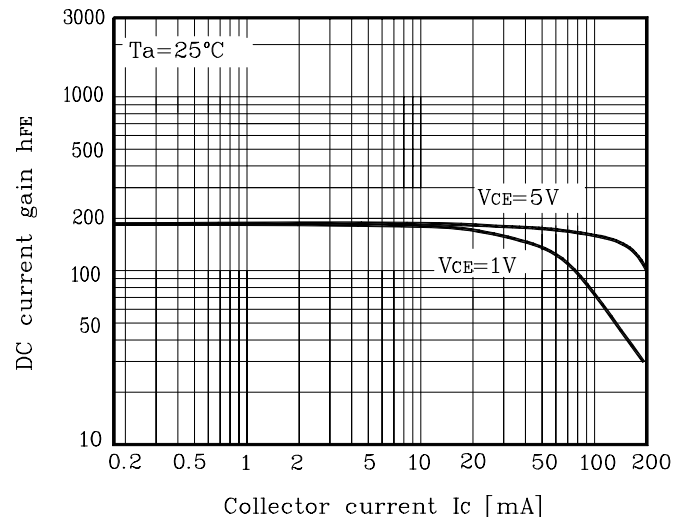

Fig. 5  $V_{CE(sat)}$  - $I_C$

