

SBCB Series



These surface mount filters are specially designed to virtually eliminate the problems of conducted EMI in data line applications. They provide both differential and common mode noise attenuation.

These components contain tremendous electrode straight, solder heat resistance and outstanding solderability. These products are designed for flow, reflow and wave soldering required for surface mounting applications.

Features

- RoHS Compliant
- Compatible with auto insertion equipment and easy installed for PC board
- four lines for voice and data line
- Compact and high performance

Applications

- Attenuating noise of analog and digital signals for telecommunication devices
- Prevention of interference from amateur radios, CB stations, or high frequency welders, etc

Product Identification

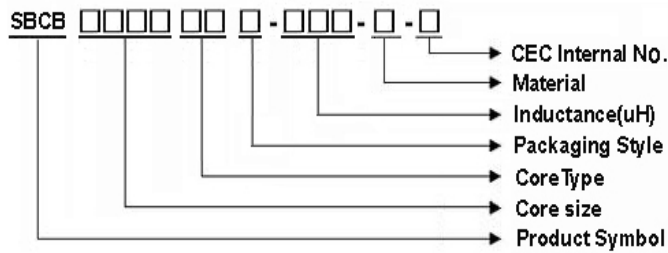

- Packaging: T : Tape and Reel

Shape and Dimensions

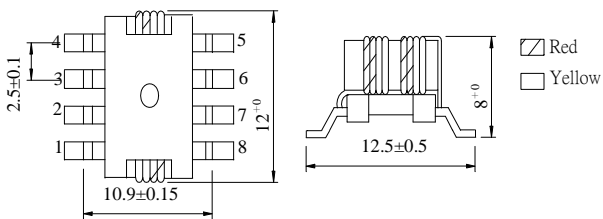

Recommended Pattern

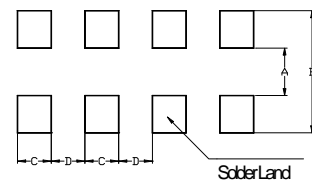

Dimensions in mm

TYPE	A	B	C	D
SBCB1104	8.0	13.0 ~ 14.0	1.15	2.0

Electrical Characteristics

Part Number	Test Frequency (KHz) 0.6V	Inductance L(μ H)	DC Resistance (Ω) Max
SBCB1104RIT-330-B3-N	100	25~50	0.07

Test Instruments : HP4192A LF Impedance Analyzer

SBCB1104RI-330-B3-N

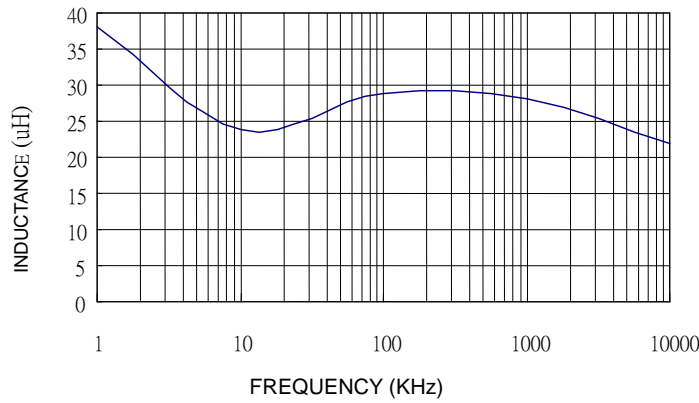

Packaging Specifications

Tape Dimensions

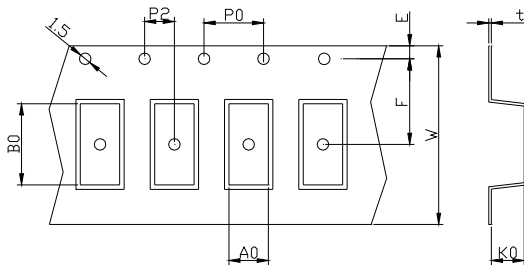

Tape Material

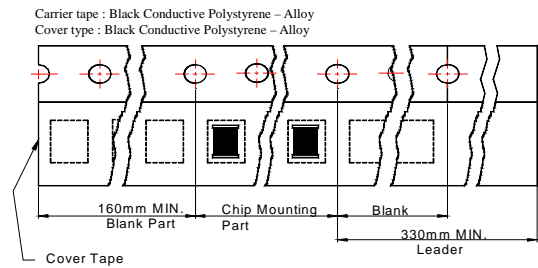

Reel Dimensions

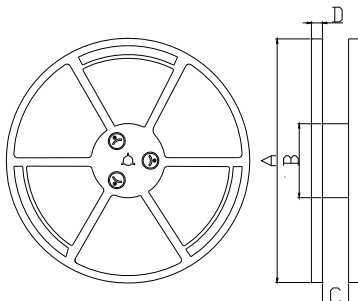

Dimensions in mm

TYPE	Tape Dimensions									Reel Dimensions				Quantity PCS / Reel
	W	E	F	P0	P2	A0	B0	K0	t	A	B	C	D	
SBCB1104	24	1.75	11.5	4	2	12.4	15.5	9.1	0.36	330	100	24.4	2.4	350