

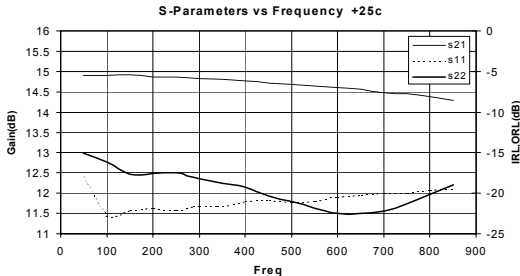

## Product Description

Sirenza Microdevices' SBF-4089 is a high performance InGaP/GaAs Heterojunction Bipolar Transistor MMIC Amplifier. A Darlington configuration designed with InGaP process technology provides broadband performance up to 0.5 GHz with excellent thermal performance. The heterojunction increases breakdown voltage and minimizes leakage current between junctions. Cancellation of emitter junction non-linearities results in higher suppression of intermodulation products. Only a single positive supply voltage, DC-blocking capacitors, a bias resistor, and an optional RF choke are required for operation.

The matte tin finish on Sirenza's lead-free package utilizes a post annealing process to mitigate tin whisker formation and is RoHS compliant per EU Directive 2002/95. This package is also manufactured with green molding compounds that contain no antimony trioxide nor halogenated fire retardants.



## SBF-4089

## SBF-4089Z



### DC-500 MHz, Cascadable

### InGaP/GaAs HBT MMIC Amplifier



## Product Features

- Available in Lead Free, RoHS compliant, & Green packaging
- IP3 = 42dBm @ 240MHz
- Stable Gain Over Temperature
- Robust 1000V ESD, Class 1C
- Operates From Single Supply
- Low Thermal Resistance

## Applications

- Receiver IF Amplifier
- Cellular, PCS, GSM, UMTS
- PA Driver Amp
- Wireless Data, Satellite Terminals

Symbol	Parameter	Units	Frequency	Min.	Typ.	Max.
G	Small Signal Gain	dB	70MHz 240 MHz 500 MHz	13.3 13.2	14.9 14.8 14.7	16.3 16.2
P <sub>1dB</sub>	Output Power at 1dB Compression	dBm	70MHz 240 MHz 400 MHz	18.4	20.1 20.1 19.9	
OIP <sub>3</sub>	Output Third Order Intercept Point	dBm	70MHz 240 MHz 400 MHz	39.0	40.0 42.0 41.0	
IRL	Input Return Loss	dB	500 MHz	13.0	17.0	
ORL	Output Return Loss	dB	500 MHz	12.0	16.0	
NF	Noise Figure	dB	500 MHz		3.3	4.3
V <sub>D</sub>	Device Operating Voltage	V		4.5	4.9	5.3
I <sub>D</sub>	Device Operating Current	mA		82	90	98
R <sub>TH, j-l</sub>	Thermal Resistance (junction to lead)	°C/W			43	

**Test Conditions:** V<sub>S</sub> = 8 V, I<sub>D</sub> = 90 mA Typ, OIP<sub>3</sub> Tone Spacing = 1 MHz, Pout per tone = 0 dBm  
R<sub>BIAS</sub> = 33 Ohms, T<sub>L</sub> = 25°C, Z<sub>S</sub> = Z<sub>L</sub> = 50 Ohms, App circuit page 4.

The information provided herein is believed to be reliable at press time. Sirenza Microdevices assumes no responsibility for inaccuracies or omissions. Sirenza Microdevices assumes no responsibility for the use of this information, and all such information shall be entirely at the user's own risk. Prices and specifications are subject to change without notice. No patent rights or licenses to any of the circuits described herein are implied or granted to any third party. Sirenza Microdevices does not authorize or warrant any Sirenza Microdevices product for use in life-support devices and/or systems. Copyright © 2001 Sirenza Microdevices, Inc. All worldwide rights reserved. [www.Datasheet4u.com](http://www.Datasheet4u.com)

**Typical RF Performance at Key Operating Frequencies**

Symbol	Parameter	Unit	Frequency (MHz)					
			70	100	240	400	500	850
G	Small Signal Gain	dB	14.9	14.9	14.9	14.8	14.7	14.3
OIP <sub>3</sub>	Output Third Order Intercept Point	dBm	40.0	40.5	42.5	41.0	40.0	35.1
P <sub>1dB</sub>	Output Power at 1dB Compression	dBm	20.1	20.1	20.1	19.9	20.1	18.1
IRL	Input Return Loss	dB	18	22	22	21	21	19
ORL	Output Return Loss	dB	15	16	17	19	21	18
S <sub>12</sub>	Reverse Isolation	dB	18	18	18	18	18	18
NF	Noise Figure	dB	3.2	3.3	3.3	3.3	3.3	3.3

**Test Conditions:** V<sub>S</sub> = 8 V, I<sub>D</sub> = 90 mA Typ., OIP<sub>3</sub> Tone Spacing = 1 MHz, P<sub>out</sub> per tone = 0 dBm  
 R<sub>BIAIS</sub> = 33 Ohms, T<sub>L</sub> = 25°C, Z<sub>S</sub> = Z<sub>L</sub> = 50 Ohms, App circuit Page 4

**Absolute Maximum Ratings**

Parameter	Absolute Limit
Max. Device Current (I <sub>b</sub> )	150 mA
Max. Device Voltage (V <sub>D</sub> )	6 V
Max. RF Input Power	+19 dBm
Max Operating Dissipated Power	0.8 W
Max. Junction Temp. (T <sub>J</sub> )	+150°C
Operating Temp. Range (T <sub>L</sub> )	-40°C to +85°C
Max. Storage Temp.	+150°C

Operation of this device beyond any one of these limits may cause permanent damage. For reliable continuous operation, the device voltage and current must not exceed the maximum operating values specified in the table on page one.

Bias Conditions should also satisfy the following expression:

$$I_b V_D < (T_L - T_J) / R_{\theta J L} \quad T_J = T_{L, EAD}$$

**P1dB vs Temp**

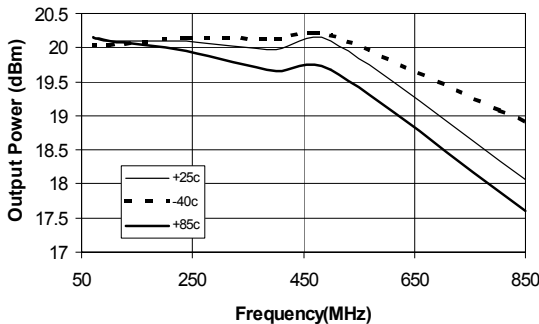

**TOIP vs Temp**

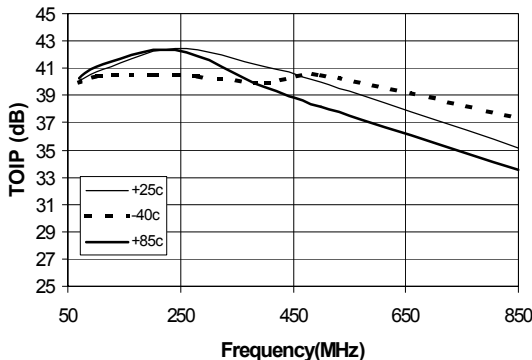

**Noise Figure vs Temp**

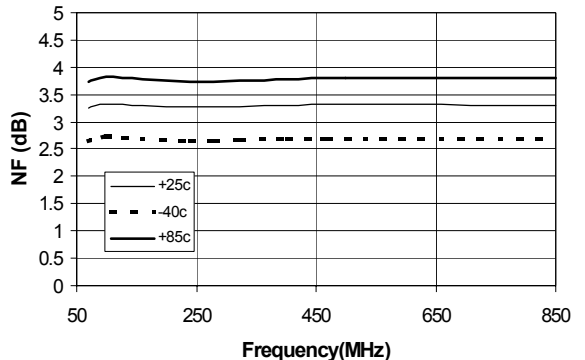

Test Conditions :  $V_s = 8v$ , R-bias = 33ohm,  $I_d = 90mA$ , Temp = +25c

**$|S_{11}|$  vs. Frequency**

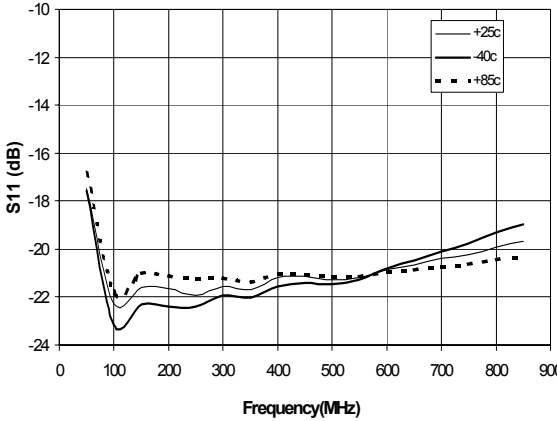

**$|S_{21}|$  vs. Frequency**

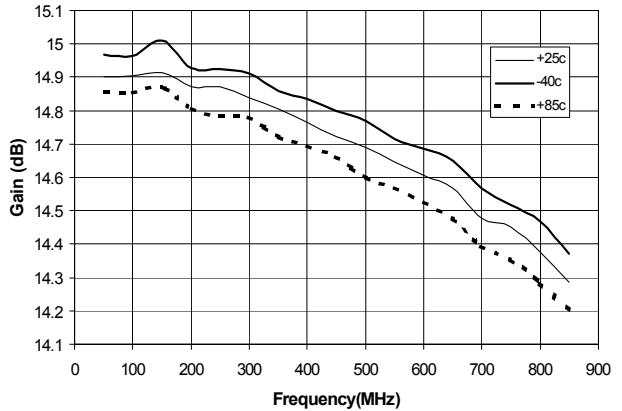

**$|S_{12}|$  vs. Frequency**

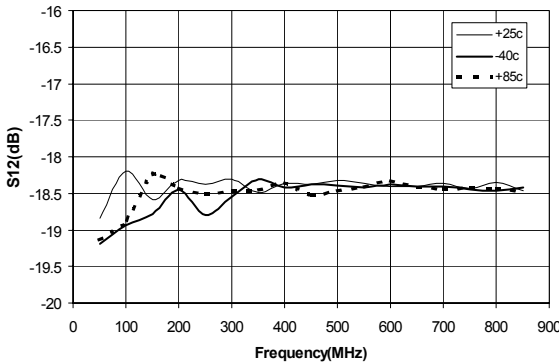

**$|S_{22}|$  vs. Frequency**

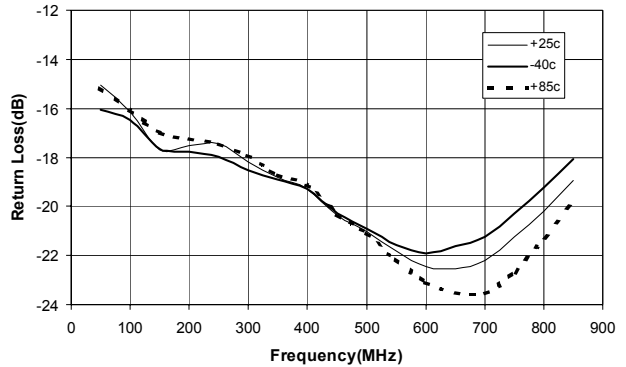

**Bias sweep vs Temp**

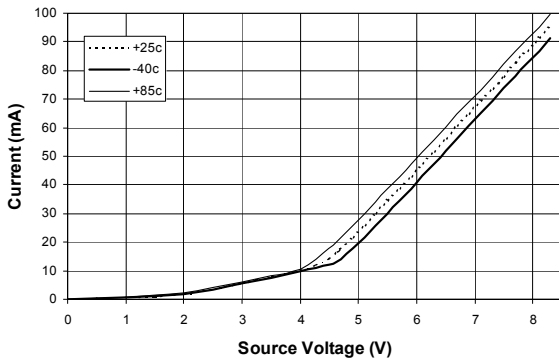

**NOTE: Output Return Loss Can be improved at low end of band with L1 selection, see Page 4 app circuit.**

**Basic Application Circuit**

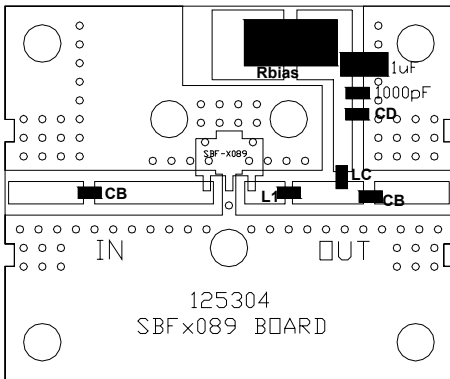
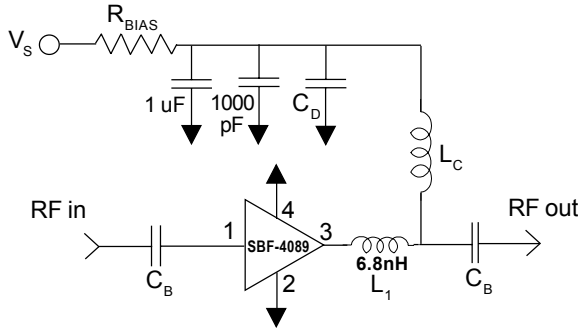

**Part Identification Marking**

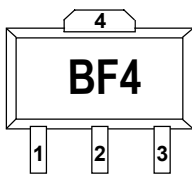

Tin-Lead

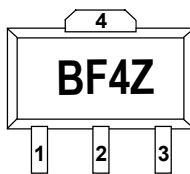

Lead Free

**Application Circuit Element Values**

Reference Designator	Frequency (Mhz)				
	70	100	240	500	850
C <sub>B</sub>	1 uF	1000 pF	1000 pF	220 pF	100 pF
C <sub>D</sub>	100pF	100 pF	100 pF	100pF	68pF
L <sub>C</sub>	6.8 uH	1.2 uH	1.2 uH	68 nH	33nH
L1	6.8nH	6.8nH	6.8nH	6.8nH	6.8nH

**Recommended Bias Resistor Values for I<sub>D</sub>=90mA**

$$R_{BIAS} = (V_S - V_D) / I_D$$

Supply Voltage(V <sub>S</sub> )	7.5 V	8 V	10 V	12 V
R <sub>BIAS</sub>	27 Ω	33 Ω	56 Ω	75 Ω

Note: R<sub>BIAS</sub> provides DC bias stability over temperature.

**Mounting Instructions**

- NOTE: For broadband RF unconditional stability do not put GND vias under the exposed backside GND paddle.
- Solder the copper pad on the backside of the device package to the ground plane.
- Use a large ground pad area with many plated through-holes as shown.
- We recommend 1 or 2 ounce copper. Measurement for this data sheet were made on a 31 mil thick FR-4 board with 1 ounce copper on both sides.

Pin #	Function	Description
1	RF IN	RF input pin. This pin requires the use of an external DC blocking capacitor chosen for the frequency of operation.
2, 4	GND	Connection to ground. Use via holes for best performance to reduce lead inductance as close to ground leads as possible.
3	RF OUT/BIAS	RF output and bias pin. DC voltage is present on this pin, therefore a DC blocking capacitor is necessary for proper operation.

**Part Number Ordering Information**

Part Number	Reel Size	Devices/Reel
SBF-4089	7"	1000
SBF-4089Z	7"	1000



**Caution: ESD sensitive**

Appropriate precautions in handling, packaging and testing devices must be observed.

**PCB Pad Layout**  
Dimensions in inches [millimeters]

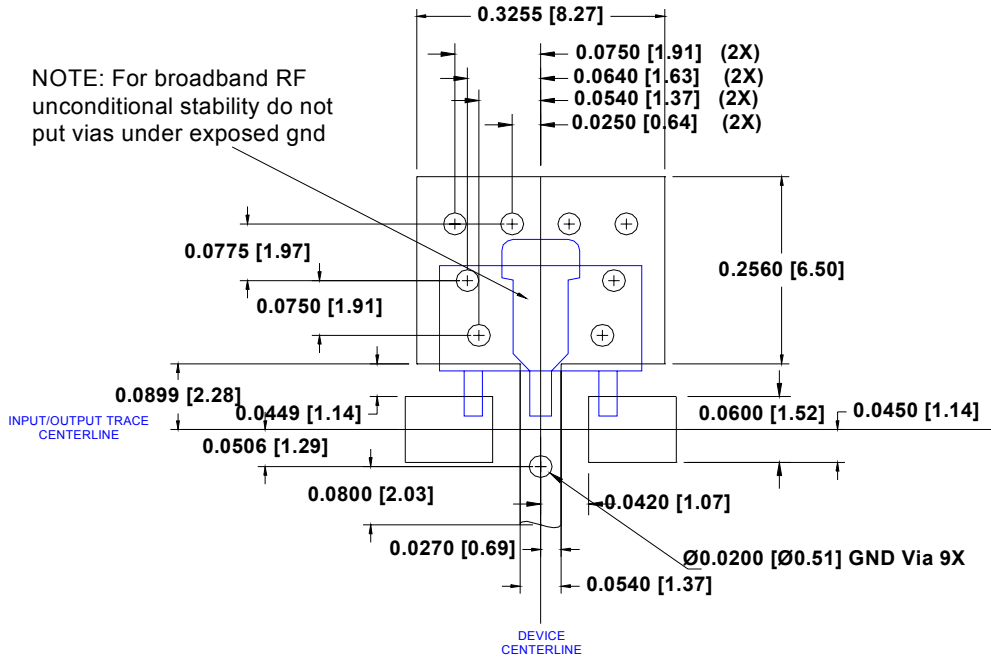

**See Application Note AN-075  
For Package Outline Drawing**