

Ordering number : ENN7494A



SANYO Semiconductors

DATA SHEET

NPN Epitaxial Planar Silicon Transistor

SBFP540M — UHF to C Band Low Noise Amplifier, Low Phase Noise Oscillation Applications

Features

- Low noise : NF=0.9dB typ (f=1.8GHz).
- High cut-off frequency : $f_T=20\text{GHz}$ typ ($V_{CE}=1\text{V}$),
: $f_T=29\text{GHz}$ typ ($V_{CE}=4\text{V}$).
- Low voltage operation.
- High Gain : $|S_{21e}|^2=18.5\text{dB}$ typ (f=1.8GHz).

Specifications

Absolute Maximum Ratings at $T_a=25^\circ\text{C}$

Parameter	Symbol	Conditions	Ratings	Unit
Collector-to-Base Voltage	V_{CBO}		14	V
Collector-to-Emitter Voltage	V_{CEO}		4.5	V
Emitter-to-Base Voltage	V_{EBO}		1	V
Collector Current	I_C		80	mA
Collector Dissipation	P_C		250	mW
Junction Temperature	T_J		150	$^\circ\text{C}$
Storage Temperature	T_{stg}		-55 to +150	$^\circ\text{C}$

Electrical Characteristics at $T_a=25^\circ\text{C}$

Parameter	Symbol	Conditions	Ratings			Unit
			min	typ	max	
Collector Cutoff Current	I_{CBO}	$V_{CB}=5\text{V}, I_E=0$			200	nA
Emitter Cutoff Current	I_{EBO}	$V_{EB}=1\text{V}, I_C=0$			70	μA
DC Current Gain	h_{FE}	$V_{CE}=3.5\text{V}, I_C=20\text{mA}$	50		200	
Gain-Bandwidth Product	$f_T(1)$	$V_{CE}=1\text{V}, I_C=10\text{mA}$		20		GHz
	$f_T(2)$	$V_{CE}=4\text{V}, I_C=50\text{mA}$	22	29		GHz
Reverse Transfer Capacitance	C_{re}	$V_{CB}=2\text{V}, f=1\text{MHz}$		0.14	0.24	pF
Forward Transfer Gain	$ S_{21e} ^2(1)$	$V_{CE}=1\text{V}, I_C=10\text{mA}, f=1.8\text{GHz}$		17.5		dB
	$ S_{21e} ^2(2)$	$V_{CE}=2\text{V}, I_C=20\text{mA}, f=1.8\text{GHz}$	16	18.5		dB
Noise Figure	NF	$V_{CE}=2\text{V}, I_C=5\text{mA}, f=1.8\text{GHz}$		0.9	1.3	dB

Marking : MC

- Any and all SANYO products described or contained herein do not have specifications that can handle applications that require extremely high levels of reliability, such as life-support systems, aircraft's control systems, or other applications whose failure can be reasonably expected to result in serious physical and/or material damage. Consult with your SANYO representative nearest you before using any SANYO products described or contained herein in such applications.
- SANYO assumes no responsibility for equipment failures that result from using products at values that exceed, even momentarily, rated values (such as maximum ratings, operating condition ranges, or other parameters) listed in products specifications of any and all SANYO products described or contained herein.

SANYO Electric Co., Ltd. Semiconductor Company

TOKYO OFFICE Tokyo Bldg., 1-10, 1 Chome, Ueno, Taito-ku, TOKYO, 110-8534 JAPAN

et4U.com

O2203 TS IM / 62503 TS IM TA-100357 No.7494-1/16

SBF540M

Package Dimensions

unit : mmm
2213

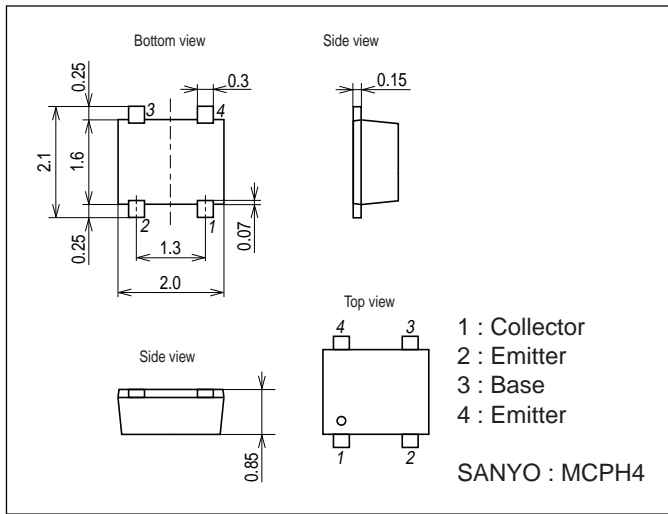

Electrical Connection

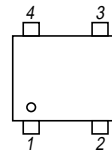

- 1 : Collector
 - 2 : Emitter
 - 3 : Base
 - 4 : Emitter
- Top view

Pay attention to handling since it is liable to be affected by static electricity due to the high-frequency process adopted.

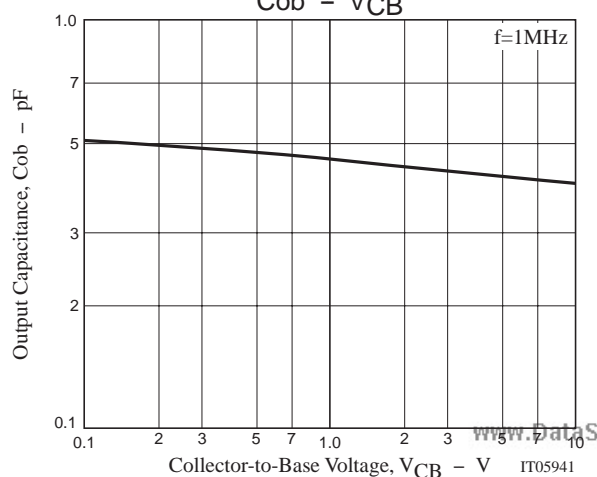
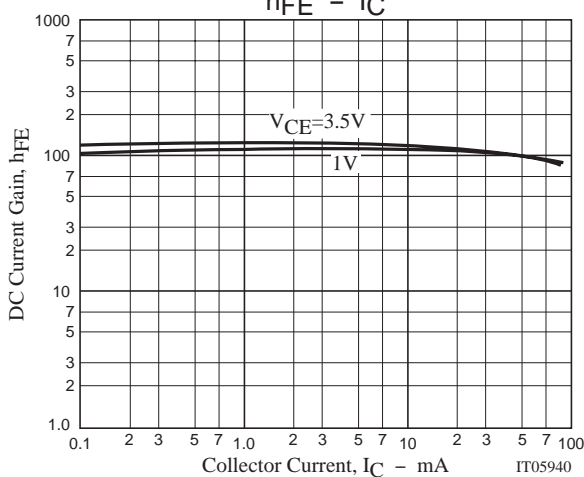
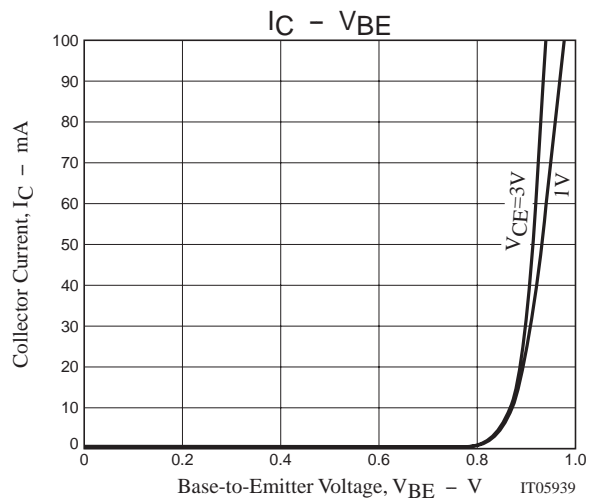
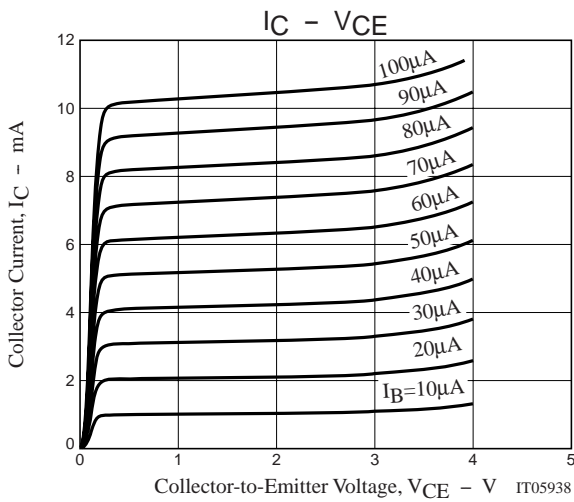

SBFP540M

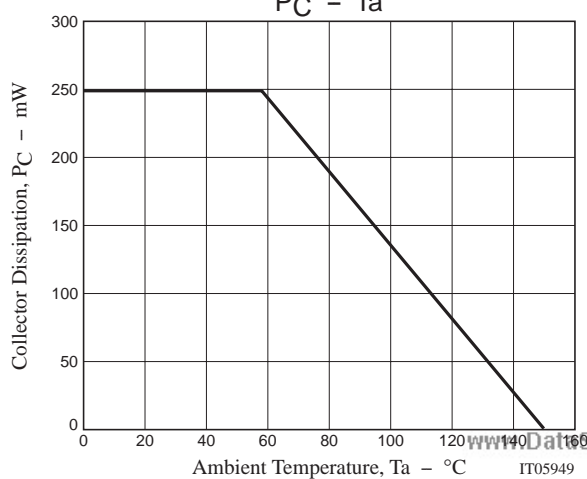
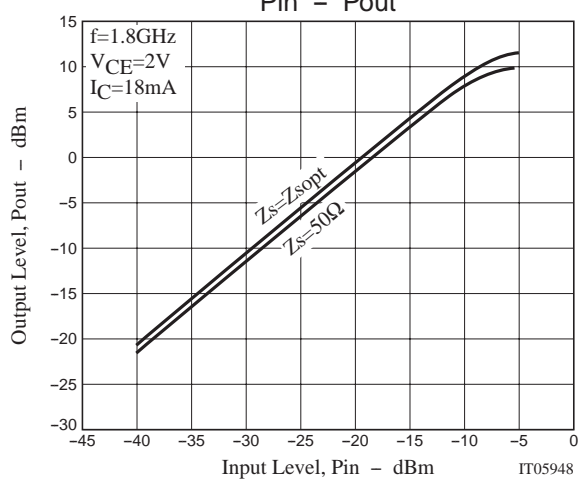
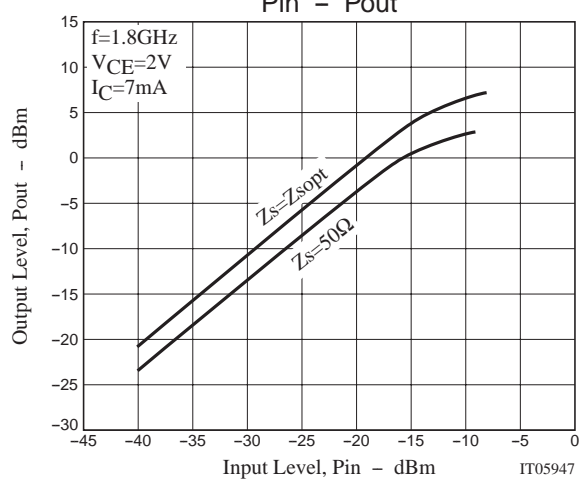
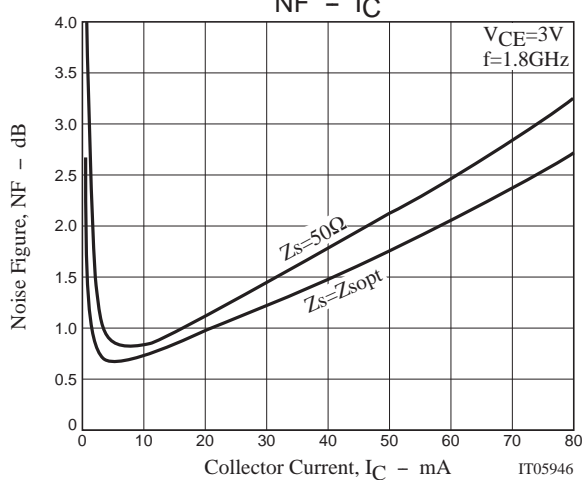
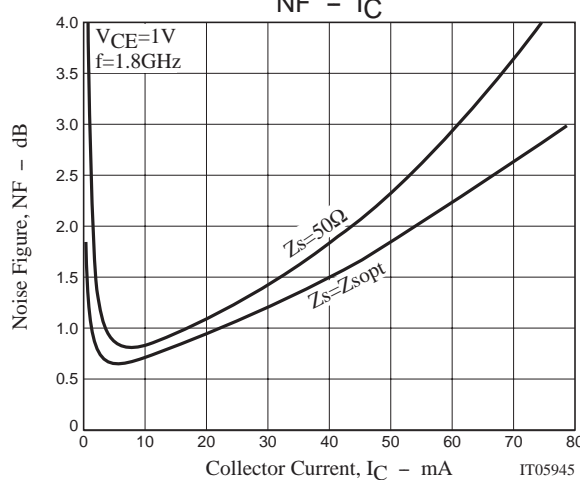
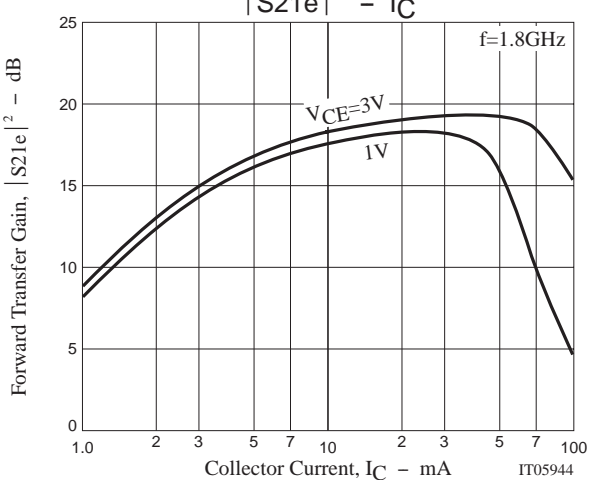
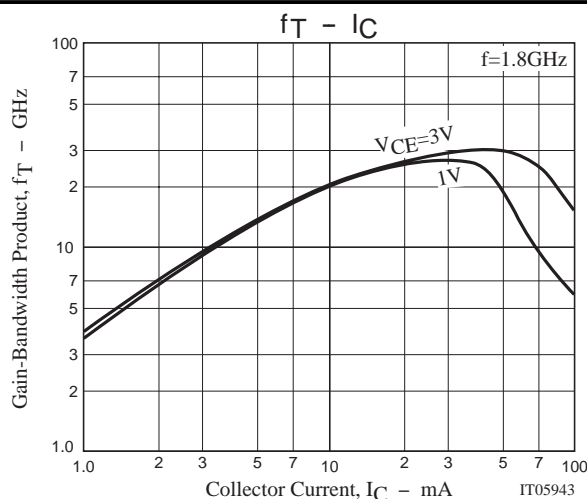
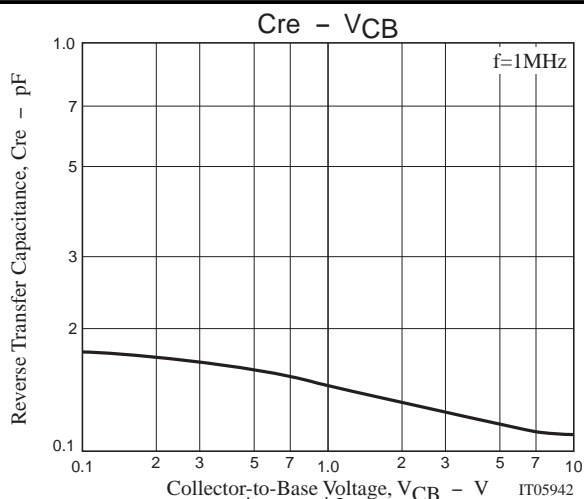

SBFP540M

S Parameters (Common emitter)

 $V_{CE}=1V, I_C=5mA, Z_O=50\Omega$

Freq(MHz)	$ S_{11} $	$\angle S_{11}$	$ S_{21} $	$\angle S_{21}$	$ S_{12} $	$\angle S_{12}$	$ S_{22} $	$\angle S_{22}$
200	0.876	-20.4	9.668	161.0	0.019	77.5	0.957	-15.3
400	0.850	-40.7	9.383	146.6	0.036	65.5	0.890	-28.0
600	0.771	-57.2	8.338	134.1	0.046	56.9	0.791	-35.9
800	0.700	-75.0	8.228	123.2	0.054	50.9	0.719	-44.4
1000	0.670	-87.8	7.416	114.3	0.061	45.1	0.644	-49.6
1200	0.607	-104.1	7.039	106.3	0.065	42.8	0.594	-54.7
1400	0.573	-115.4	6.399	100.0	0.069	40.1	0.554	-57.3
1600	0.542	-125.5	5.881	93.8	0.071	38.9	0.507	-60.1
1800	0.520	-134.6	5.388	89.0	0.074	37.9	0.486	-63.2
2000	0.504	-141.7	4.792	84.6	0.077	37.2	0.475	-62.5
2200	0.500	-149.5	4.619	80.2	0.079	36.4	0.441	-65.9
2400	0.490	-156.6	4.326	75.8	0.083	35.3	0.422	-67.4
2600	0.481	-162.8	3.999	71.4	0.085	35.5	0.408	-68.0
2800	0.477	-168.3	3.685	68.1	0.089	34.8	0.406	-68.4
3000	0.477	-174.8	3.609	64.7	0.091	34.7	0.373	-72.0
3200	0.478	179.5	3.418	61.0	0.093	34.2	0.355	-73.6
3400	0.472	173.7	3.239	57.6	0.095	34.5	0.342	-75.2
3600	0.473	169.4	3.086	54.3	0.098	33.5	0.328	-77.7
3800	0.477	165.0	2.949	50.9	0.101	33.6	0.315	-79.5
4000	0.484	160.1	2.809	47.7	0.104	32.9	0.301	-81.7
4200	0.485	155.6	2.696	44.5	0.107	32.6	0.288	-84.4
4400	0.480	151.3	2.599	41.4	0.110	31.9	0.276	-87.9
4600	0.487	147.7	2.494	38.4	0.113	31.1	0.267	-90.6
4800	0.496	143.9	2.408	35.7	0.115	31.0	0.259	-92.6
5000	0.498	139.5	2.325	32.6	0.121	30.4	0.250	-96.5
5200	0.500	136.1	2.213	29.5	0.122	29.3	0.257	-98.9
5400	0.495	132.5	2.167	26.6	0.127	28.6	0.245	-102.5
5600	0.501	129.5	2.033	24.1	0.129	27.7	0.263	-104.0
5800	0.504	126.1	2.032	21.4	0.132	26.9	0.243	-108.8
6000	0.502	121.7	1.974	18.3	0.137	25.7	0.242	-110.7

SBFP540M

S Parameters (Common emitter)

$V_{CE}=1V, I_C=10mA, Z_O=50\Omega$

Freq(MHz)	$ S_{11} $	$\angle S_{11}$	$ S_{21} $	$\angle S_{21}$	$ S_{12} $	$\angle S_{12}$	$ S_{22} $	$\angle S_{22}$
200	0.707	-34.7	22.662	155.4	0.017	74.7	0.916	-21.3
400	0.663	-64.5	19.734	136.3	0.030	62.5	0.801	-38.1
600	0.553	-83.7	16.022	121.3	0.038	53.7	0.673	-50.1
800	0.518	-99.6	13.440	111.9	0.044	53.4	0.602	-54.0
1000	0.477	-117.4	11.232	103.1	0.050	49.3	0.508	-56.9
1200	0.458	-128.7	9.820	96.5	0.052	49.5	0.460	-65.7
1400	0.439	-138.8	8.529	91.3	0.058	48.9	0.417	-66.8
1600	0.431	-147.0	7.615	86.1	0.062	47.8	0.398	-69.0
1800	0.419	-154.2	6.842	82.4	0.066	49.1	0.357	-69.3
2000	0.408	-160.9	6.116	79.0	0.069	49.0	0.349	-69.5
2200	0.402	-167.4	5.675	75.2	0.074	48.0	0.323	-73.7
2400	0.403	-172.2	5.259	71.3	0.079	46.9	0.315	-73.6
2600	0.399	-177.0	4.892	67.7	0.083	48.1	0.296	-74.9
2800	0.403	177.1	4.523	64.7	0.086	46.8	0.287	-75.5
3000	0.408	171.3	4.304	61.4	0.092	44.7	0.270	-79.2
3200	0.410	166.7	4.061	58.4	0.096	46.5	0.254	-78.7
3400	0.411	162.5	3.823	55.4	0.099	44.5	0.241	-80.0
3600	0.415	158.2	3.639	52.3	0.105	42.7	0.223	-83.4
3800	0.416	154.5	3.468	49.4	0.107	42.6	0.214	-86.7
4000	0.416	151.4	3.292	46.5	0.114	41.3	0.208	-90.3
4200	0.433	147.9	3.159	43.8	0.120	39.9	0.192	-91.4
4400	0.434	143.4	3.034	40.9	0.121	38.5	0.176	-97.0
4600	0.438	141.0	2.911	38.1	0.129	38.2	0.167	-100.7
4800	0.440	137.3	2.813	35.2	0.132	37.2	0.169	-102.6
5000	0.450	133.8	2.711	32.5	0.137	35.0	0.158	-106.3
5200	0.457	130.2	2.616	29.9	0.140	34.5	0.156	-109.8
5400	0.452	126.7	2.522	27.1	0.143	31.7	0.154	-115.5
5600	0.453	124.1	2.420	24.8	0.147	31.0	0.165	-114.8
5800	0.457	120.7	2.368	22.0	0.151	30.1	0.154	-119.8
6000	0.459	117.2	2.308	19.0	0.154	28.1	0.147	-122.1

SBFP540M

S Parameters (Common emitter)

V_{CE}=1V, I_C=20mA, Z_O=50Ω

Freq(MHz)	S ₁₁	∠S ₁₁	S ₂₁	∠S ₂₁	S ₁₂	∠S ₁₂	S ₂₂	∠S ₂₂
200	0.537	-53.4	33.150	147.3	0.015	70.0	0.852	-28.8
400	0.506	-88.9	26.213	126.0	0.026	61.0	0.685	-48.4
600	0.415	-110.0	19.932	111.8	0.031	56.9	0.547	-59.4
800	0.397	-123.5	15.931	103.4	0.035	56.5	0.476	-62.4
1000	0.387	-140.8	13.023	96.3	0.041	56.7	0.386	-63.7
1200	0.381	-149.3	11.107	90.1	0.046	57.0	0.354	-73.1
1400	0.376	-158.0	9.608	85.9	0.051	58.1	0.312	-73.8
1600	0.371	-164.0	8.458	81.8	0.058	56.9	0.307	-75.6
1800	0.368	-169.9	7.533	78.4	0.061	58.7	0.271	-74.4
2000	0.362	-176.5	6.826	75.4	0.067	57.0	0.259	-76.3
2200	0.360	179.0	6.200	71.5	0.073	57.7	0.243	-79.3
2400	0.362	174.8	5.765	68.4	0.080	56.6	0.241	-78.7
2600	0.358	171.1	5.366	65.3	0.084	55.6	0.226	-80.9
2800	0.365	165.2	4.976	62.4	0.091	52.0	0.208	-80.3
3000	0.376	161.0	4.676	59.1	0.094	53.0	0.199	-83.5
3200	0.374	157.3	4.401	56.5	0.101	49.9	0.186	-83.3
3400	0.377	153.5	4.142	53.7	0.106	51.1	0.174	-85.0
3600	0.385	149.6	3.941	51.0	0.114	48.0	0.158	-89.8
3800	0.384	146.6	3.762	48.2	0.114	47.2	0.149	-95.3
4000	0.387	144.4	3.566	45.5	0.120	45.7	0.143	-97.0
4200	0.407	141.1	3.418	43.0	0.127	43.6	0.130	-102.8
4400	0.408	137.5	3.282	40.3	0.131	42.0	0.119	-109.2
4600	0.415	134.9	3.134	37.6	0.136	41.5	0.110	-114.6
4800	0.417	132.0	3.019	34.9	0.139	39.9	0.112	-118.0
5000	0.425	128.4	2.919	32.3	0.147	37.7	0.105	-122.6
5200	0.430	125.1	2.835	29.7	0.151	35.7	0.100	-125.7
5400	0.428	122.0	2.719	27.0	0.154	34.4	0.102	-135.4
5600	0.430	119.6	2.641	24.8	0.157	32.6	0.110	-133.9
5800	0.433	116.5	2.557	21.9	0.162	31.7	0.103	-138.8
6000	0.437	112.9	2.483	19.3	0.167	29.0	0.100	-142.1

SBFP540M

S Parameters (Common emitter)

V_{CE}=1V, I_C=40mA, Z_O=50Ω

Freq(MHz)	S ₁₁	∠S ₁₁	S ₂₁	∠S ₂₁	S ₁₂	∠S ₁₂	S ₂₂	∠S ₂₂
200	0.419	-92.2	37.063	136.8	0.013	64.9	0.725	-37.5
400	0.444	-123.4	26.701	116.1	0.022	63.0	0.539	-56.3
600	0.398	-142.6	19.635	104.1	0.027	63.1	0.411	-67.6
800	0.388	-150.9	15.453	96.8	0.033	65.0	0.365	-68.5
1000	0.405	-163.9	12.829	91.3	0.039	65.9	0.292	-69.4
1200	0.405	-168.1	10.462	85.8	0.045	63.4	0.271	-78.5
1400	0.403	-174.7	9.240	81.8	0.051	64.6	0.218	-79.3
1600	0.407	-179.8	7.866	78.3	0.057	61.9	0.238	-78.8
1800	0.407	175.2	7.087	74.8	0.065	63.4	0.195	-81.3
2000	0.399	169.8	6.479	72.1	0.070	61.8	0.200	-78.0
2200	0.396	167.2	5.842	68.1	0.075	61.3	0.177	-85.3
2400	0.395	162.9	5.379	65.5	0.082	60.0	0.186	-83.0
2600	0.392	159.2	5.024	62.7	0.089	59.7	0.165	-89.0
2800	0.401	154.4	4.712	60.0	0.094	57.9	0.155	-83.9
3000	0.414	150.3	4.362	56.7	0.100	54.9	0.143	-93.0
3200	0.414	147.1	4.081	54.2	0.109	54.3	0.125	-86.8
3400	0.420	143.8	3.862	51.5	0.112	53.2	0.113	-94.4
3600	0.436	140.3	3.678	48.5	0.119	51.8	0.103	-96.2
3800	0.430	137.8	3.490	46.1	0.125	50.4	0.096	-108.1
4000	0.432	135.3	3.340	43.5	0.127	47.6	0.098	-109.1
4200	0.451	132.5	3.174	40.7	0.136	47.2	0.093	-110.5
4400	0.469	128.9	3.052	37.9	0.141	45.7	0.077	-125.3
4600	0.469	127.0	2.899	35.2	0.146	41.6	0.075	-142.1
4800	0.471	124.1	2.801	32.3	0.149	41.2	0.079	-131.3
5000	0.486	121.5	2.690	30.0	0.156	39.5	0.067	-139.1
5200	0.488	118.8	2.669	27.9	0.159	37.8	0.075	-158.4
5400	0.497	116.1	2.503	25.1	0.164	36.2	0.075	-164.2
5600	0.493	114.2	2.527	23.0	0.167	34.0	0.080	-156.0
5800	0.499	110.9	2.365	19.9	0.174	31.2	0.079	-160.2
6000	0.503	107.6	2.314	17.1	0.175	29.8	0.070	-171.7

SBFP540M

S Parameters (Common emitter)

$V_{CE}=2V$, $I_C=5mA$, $Z_O=50\Omega$

Freq(MHz)	$ S_{11} $	$\angle S_{11}$	$ S_{21} $	$\angle S_{21}$	$ S_{12} $	$\angle S_{12}$	$ S_{22} $	$\angle S_{22}$
200	0.830	-22.9	13.797	162.5	0.016	78.6	0.963	-13.1
400	0.809	-44.1	12.849	147.2	0.030	68.1	0.909	-24.5
600	0.727	-60.6	11.142	134.1	0.039	59.9	0.832	-32.5
800	0.685	-76.7	10.049	123.4	0.047	53.4	0.753	-39.5
1000	0.653	-90.0	8.799	114.1	0.054	48.2	0.695	-44.3
1200	0.598	-102.4	8.026	107.1	0.057	45.6	0.646	-48.6
1400	0.572	-112.2	7.176	100.7	0.060	43.1	0.606	-52.1
1600	0.547	-121.5	6.505	94.7	0.064	41.7	0.567	-54.7
1800	0.521	-130.0	5.933	89.9	0.066	41.3	0.538	-56.9
2000	0.505	-136.8	5.227	85.6	0.069	39.9	0.532	-57.6
2200	0.493	-144.0	5.005	81.1	0.071	39.1	0.495	-60.2
2400	0.481	-150.5	4.651	77.1	0.074	38.8	0.476	-61.6
2600	0.473	-156.0	4.280	73.0	0.076	38.4	0.465	-61.8
2800	0.466	-161.6	3.929	69.8	0.079	37.7	0.459	-62.7
3000	0.458	-168.7	3.863	66.3	0.081	38.3	0.427	-65.8
3200	0.457	-174.2	3.645	62.8	0.082	37.7	0.410	-67.2
3400	0.455	-179.8	3.464	59.5	0.085	37.6	0.400	-68.4
3600	0.455	174.9	3.297	56.2	0.087	38.2	0.386	-70.1
3800	0.458	170.3	3.146	53.1	0.091	37.8	0.375	-71.7
4000	0.463	165.8	3.002	50.0	0.093	37.6	0.364	-73.6
4200	0.468	160.9	2.885	46.9	0.096	37.2	0.352	-75.8
4400	0.471	156.3	2.783	43.7	0.099	36.7	0.339	-78.0
4600	0.478	152.0	2.671	40.7	0.101	36.6	0.331	-80.2
4800	0.483	148.4	2.567	37.8	0.104	36.1	0.323	-82.5
5000	0.483	144.4	2.487	34.9	0.108	35.7	0.316	-85.0
5200	0.493	141.5	2.356	32.1	0.110	35.0	0.320	-87.3
5400	0.491	137.6	2.322	29.1	0.115	34.4	0.307	-90.3
5600	0.500	134.5	2.179	26.7	0.117	33.6	0.323	-93.2
5800	0.500	131.6	2.170	23.6	0.121	33.3	0.308	-95.7
6000	0.501	127.8	2.114	20.6	0.124	31.9	0.305	-98.5

SBFP540M

S Parameters (Common emitter)

V_{CE}=2V, I_C=10mA, Z_O=50Ω

Freq(MHz)	S ₁₁	∠S ₁₁	S ₂₁	∠S ₂₁	S ₁₂	∠S ₁₂	S ₂₂	∠S ₂₂
200	0.705	-31.6	23.214	157.0	0.014	74.6	0.932	-18.1
400	0.663	-59.0	20.346	138.4	0.026	64.6	0.832	-32.6
600	0.570	-78.7	16.818	124.1	0.032	58.2	0.721	-40.8
800	0.526	-95.5	14.144	113.5	0.038	54.2	0.628	-47.6
1000	0.497	-109.1	12.009	105.0	0.043	52.0	0.564	-52.0
1200	0.459	-121.0	10.465	98.6	0.047	51.9	0.516	-55.0
1400	0.438	-129.9	9.179	93.0	0.050	51.0	0.482	-58.0
1600	0.423	-138.4	8.140	87.9	0.054	51.2	0.446	-59.9
1800	0.409	-146.2	7.337	83.7	0.058	51.6	0.421	-61.4
2000	0.399	-152.6	6.547	80.0	0.062	50.8	0.412	-62.2
2200	0.389	-159.0	6.103	76.1	0.066	51.2	0.385	-63.8
2400	0.383	-164.6	5.631	72.6	0.070	50.5	0.370	-64.8
2600	0.379	-169.7	5.211	69.1	0.074	50.1	0.358	-64.7
2800	0.376	-174.7	4.826	66.2	0.078	49.5	0.350	-65.6
3000	0.373	179.2	4.598	63.0	0.082	49.4	0.327	-68.1
3200	0.376	174.2	4.335	60.0	0.086	48.8	0.315	-69.2
3400	0.377	169.4	4.107	57.0	0.090	47.5	0.305	-70.3
3600	0.382	164.7	3.896	54.1	0.095	47.5	0.293	-71.7
3800	0.385	160.6	3.717	51.3	0.099	46.5	0.282	-73.3
4000	0.393	156.9	3.548	48.5	0.102	45.4	0.271	-75.3
4200	0.400	152.4	3.398	45.6	0.106	44.7	0.260	-77.3
4400	0.406	148.5	3.259	42.7	0.111	43.6	0.248	-79.7
4600	0.414	144.7	3.133	40.0	0.114	42.3	0.241	-82.0
4800	0.421	141.6	3.011	37.3	0.118	41.2	0.232	-84.2
5000	0.425	138.1	2.912	34.7	0.122	40.1	0.226	-86.7
5200	0.432	135.3	2.793	32.0	0.125	38.6	0.226	-89.4
5400	0.434	132.0	2.716	29.3	0.130	37.6	0.217	-92.5
5600	0.441	129.3	2.606	26.8	0.133	36.4	0.226	-95.3
5800	0.441	126.5	2.548	23.9	0.138	34.8	0.218	-97.9
6000	0.442	122.8	2.483	21.2	0.140	33.5	0.216	-100.8

SBFP540M

S Parameters (Common emitter)

$V_{CE}=2V$, $I_C=20mA$, $Z_O=50\Omega$

Freq(MHz)	$ S_{11} $	$\angle S_{11}$	$ S_{21} $	$\angle S_{21}$	$ S_{12} $	$\angle S_{12}$	$ S_{22} $	$\angle S_{22}$
200	0.536	-44.9	34.694	150.4	0.013	72.5	0.883	-23.8
400	0.493	-79.0	27.733	129.0	0.021	65.4	0.733	-40.1
600	0.419	-100.8	21.450	114.9	0.026	60.8	0.606	-47.4
800	0.393	-117.0	17.173	105.3	0.031	60.3	0.512	-53.2
1000	0.381	-129.7	14.203	97.9	0.036	59.5	0.454	-56.7
1200	0.362	-140.3	12.103	92.3	0.041	59.9	0.416	-58.5
1400	0.351	-147.7	10.460	87.5	0.045	60.8	0.386	-61.0
1600	0.346	-155.0	9.212	83.2	0.051	60.6	0.360	-62.3
1800	0.338	-161.5	8.220	79.4	0.055	60.3	0.339	-63.1
2000	0.334	-167.3	7.408	76.0	0.060	59.8	0.331	-64.1
2200	0.328	-172.6	6.778	72.7	0.065	59.3	0.312	-65.0
2400	0.325	-177.6	6.252	69.6	0.070	58.9	0.299	-65.7
2600	0.324	178.1	5.802	66.5	0.075	58.0	0.290	-65.7
2800	0.324	173.5	5.395	63.8	0.080	57.3	0.280	-66.1
3000	0.324	168.4	5.068	60.9	0.085	55.9	0.265	-68.1
3200	0.330	164.1	4.769	58.1	0.090	55.1	0.253	-69.3
3400	0.333	160.0	4.511	55.4	0.095	53.7	0.246	-70.3
3600	0.338	156.0	4.275	52.7	0.100	52.7	0.235	-71.4
3800	0.343	152.4	4.077	50.0	0.105	51.0	0.224	-73.2
4000	0.353	149.3	3.893	47.4	0.110	50.3	0.214	-75.1
4200	0.361	145.5	3.722	44.7	0.113	48.5	0.204	-77.7
4400	0.369	142.1	3.563	42.0	0.119	47.2	0.194	-80.1
4600	0.378	138.6	3.423	39.5	0.123	45.4	0.186	-82.7
4800	0.385	135.8	3.293	36.9	0.126	44.1	0.178	-85.0
5000	0.391	132.9	3.181	34.4	0.131	42.7	0.172	-88.0
5200	0.396	130.2	3.066	31.9	0.135	40.9	0.168	-90.6
5400	0.400	127.5	2.966	29.3	0.139	39.5	0.164	-93.7
5600	0.406	124.9	2.871	26.9	0.143	38.0	0.165	-97.0
5800	0.408	122.2	2.786	24.2	0.148	36.3	0.163	-100.1
6000	0.408	118.7	2.718	21.5	0.152	34.6	0.162	-102.7

SBFP540M

S Parameters (Common emitter)

$V_{CE}=3V, I_C=5mA, Z_O=50\Omega$

Freq(MHz)	$ S_{11} $	$\angle S_{11}$	$ S_{21} $	$\angle S_{21}$	$ S_{12} $	$\angle S_{12}$	$ S_{22} $	$\angle S_{22}$
200	0.841	-23.5	13.680	161.4	0.015	74.7	0.963	-13.3
400	0.818	-45.8	12.839	145.5	0.028	65.8	0.916	-25.1
600	0.728	-61.4	11.144	130.5	0.036	54.8	0.833	-36.1
800	0.688	-78.2	10.131	119.9	0.043	51.5	0.787	-41.0
1000	0.621	-96.2	8.897	108.6	0.049	42.1	0.720	-44.8
1200	0.589	-110.1	8.174	99.5	0.054	39.6	0.658	-53.2
1400	0.547	-122.9	7.224	91.8	0.054	36.0	0.623	-55.9
1600	0.527	-132.9	6.607	85.1	0.059	32.8	0.559	-59.5
1800	0.497	-142.7	5.968	79.4	0.062	33.3	0.560	-61.5
2000	0.472	-151.3	5.202	74.3	0.062	29.8	0.552	-63.4
2200	0.461	-159.5	5.029	68.8	0.065	28.5	0.521	-67.9
2400	0.464	-166.6	4.713	63.4	0.068	27.1	0.511	-69.6
2600	0.455	-173.4	4.351	57.9	0.071	25.8	0.497	-71.2
2800	0.459	177.7	3.972	53.1	0.073	22.4	0.489	-73.3
3000	0.456	170.3	3.904	48.5	0.073	24.3	0.463	-77.4
3200	0.453	163.6	3.700	44.1	0.077	20.7	0.453	-78.9
3400	0.449	157.0	3.488	39.7	0.080	20.6	0.433	-81.1
3600	0.452	150.9	3.325	35.2	0.082	19.3	0.415	-84.7
3800	0.446	145.5	3.177	30.9	0.083	18.5	0.405	-87.6
4000	0.448	140.4	3.027	26.8	0.087	17.4	0.397	-90.7
4200	0.460	134.5	2.922	22.7	0.092	15.2	0.381	-92.6
4400	0.454	128.9	2.805	18.5	0.095	14.5	0.366	-96.3
4600	0.460	124.0	2.696	14.3	0.096	13.5	0.362	-98.8
4800	0.463	118.5	2.607	9.9	0.100	10.8	0.359	-102.5
5000	0.461	112.9	2.525	5.8	0.102	9.9	0.351	-105.6
5200	0.464	108.1	2.396	1.8	0.105	7.1	0.351	-108.9
5400	0.451	103.3	2.343	-2.2	0.108	6.0	0.339	-113.6
5600	0.458	99.2	2.202	-5.7	0.113	4.2	0.360	-117.4
5800	0.459	94.3	2.206	-9.8	0.116	2.1	0.341	-120.0
6000	0.465	89.1	2.148	-13.8	0.122	0.9	0.337	-122.6

SBFP540M

S Parameters (Common emitter)

V_{CE}=3V, I_C=10mA, Z_O=50Ω

Freq(MHz)	S ₁₁	∠S ₁₁	S ₂₁	∠S ₂₁	S ₁₂	∠S ₁₂	S ₂₂	∠S ₂₂
200	0.715	-31.7	23.200	156.0	0.014	69.6	0.935	-17.8
400	0.672	-59.9	20.567	136.8	0.024	61.5	0.843	-32.4
600	0.561	-79.2	16.910	120.4	0.030	55.6	0.729	-43.5
800	0.517	-96.4	14.395	109.8	0.035	51.9	0.668	-47.8
1000	0.469	-115.6	12.185	99.2	0.040	47.6	0.586	-50.4
1200	0.443	-128.2	10.665	91.0	0.044	43.2	0.538	-58.8
1400	0.419	-140.4	9.277	84.1	0.047	44.1	0.498	-60.5
1600	0.406	-150.5	8.295	78.1	0.051	42.4	0.482	-63.3
1800	0.387	-159.2	7.362	73.1	0.055	42.3	0.443	-64.5
2000	0.370	-168.5	6.550	68.3	0.059	40.1	0.434	-66.0
2200	0.361	-175.5	6.131	63.5	0.063	40.1	0.416	-69.6
2400	0.364	179.0	5.710	58.9	0.066	38.0	0.409	-71.2
2600	0.364	173.1	5.294	54.0	0.068	37.6	0.392	-73.0
2800	0.371	165.0	4.863	49.6	0.075	35.0	0.386	-75.0
3000	0.372	158.3	4.649	45.3	0.077	32.6	0.372	-78.0
3200	0.370	152.4	4.380	41.2	0.081	31.0	0.363	-79.1
3400	0.371	146.8	4.125	37.2	0.084	29.2	0.345	-81.5
3600	0.372	141.4	3.928	33.2	0.087	28.4	0.328	-85.5
3800	0.373	136.7	3.746	29.3	0.091	25.6	0.314	-88.1
4000	0.379	132.3	3.568	25.6	0.096	25.5	0.309	-91.1
4200	0.391	126.9	3.436	21.6	0.101	21.5	0.294	-92.7
4400	0.385	121.9	3.291	17.7	0.104	21.0	0.280	-96.4
4600	0.395	117.5	3.171	13.8	0.110	19.0	0.273	-99.7
4800	0.398	112.2	3.075	9.7	0.113	15.2	0.271	-102.4
5000	0.400	107.2	2.966	5.7	0.119	13.2	0.264	-105.5
5200	0.399	101.6	2.847	1.7	0.124	11.1	0.259	-108.7
5400	0.390	97.8	2.747	-1.9	0.125	8.5	0.251	-113.6
5600	0.397	94.7	2.637	-5.3	0.129	6.2	0.262	-117.7
5800	0.395	89.9	2.592	-9.4	0.132	4.0	0.255	-119.8
6000	0.401	84.8	2.529	-13.1	0.136	0.9	0.251	-122.3

SBFP540M

S Parameters (Common emitter)

V_{CE}=3V, I_C=20mA, Z_O=50Ω

Freq(MHz)	S ₁₁	∠S ₁₁	S ₂₁	∠S ₂₁	S ₁₂	∠S ₁₂	S ₂₂	∠S ₂₂
200	0.547	-43.7	34.553	149.7	0.012	73.1	0.889	-22.9
400	0.497	-78.1	28.092	127.6	0.019	68.3	0.749	-39.0
600	0.399	-100.2	21.594	111.6	0.025	57.4	0.626	-49.3
800	0.373	-116.0	17.425	101.5	0.030	56.2	0.560	-52.3
1000	0.355	-135.9	14.386	92.3	0.033	53.7	0.482	-53.8
1200	0.344	-146.9	12.314	85.2	0.037	54.3	0.441	-62.1
1400	0.332	-158.5	10.565	79.2	0.043	52.8	0.408	-62.8
1600	0.328	-166.0	9.336	73.9	0.048	54.0	0.399	-64.9
1800	0.319	-174.4	8.304	69.1	0.052	51.7	0.368	-65.1
2000	0.311	177.2	7.414	64.8	0.056	48.4	0.356	-66.7
2200	0.308	171.2	6.802	60.4	0.062	48.5	0.345	-70.1
2400	0.307	166.6	6.341	55.9	0.067	46.0	0.344	-71.3
2600	0.304	161.3	5.879	51.5	0.073	43.4	0.326	-72.7
2800	0.317	153.8	5.427	47.3	0.077	39.9	0.319	-74.6
3000	0.325	148.9	5.123	43.1	0.081	39.5	0.313	-77.7
3200	0.323	142.6	4.818	39.5	0.085	37.2	0.304	-78.8
3400	0.325	138.1	4.524	35.7	0.091	34.3	0.292	-80.5
3600	0.331	133.3	4.297	31.8	0.095	33.7	0.275	-84.9
3800	0.331	128.8	4.095	28.1	0.100	30.1	0.262	-88.3
4000	0.334	125.2	3.911	24.6	0.102	27.9	0.254	-91.5
4200	0.350	120.1	3.767	20.8	0.110	24.4	0.244	-92.8
4400	0.348	115.8	3.600	17.1	0.114	22.3	0.224	-96.2
4600	0.355	111.4	3.469	13.5	0.117	21.5	0.217	-99.0
4800	0.359	106.7	3.355	9.5	0.121	17.4	0.216	-102.8
5000	0.362	101.7	3.246	5.6	0.127	15.2	0.210	-105.2
5200	0.362	97.0	3.122	1.7	0.131	12.9	0.201	-108.5
5400	0.357	93.2	3.000	-1.8	0.134	10.0	0.196	-113.8
5600	0.364	89.9	2.914	-5.2	0.136	6.8	0.203	-117.3
5800	0.362	85.6	2.827	-9.0	0.141	5.1	0.199	-118.8
6000	0.368	80.2	2.762	-12.9	0.148	2.6	0.199	-121.3

SBFP540M

S Parameters (Common emitter)

V_{CE}=3V, I_C=40mA, Z_O=50Ω

Freq(MHz)	S ₁₁	∠S ₁₁	S ₂₁	∠S ₂₁	S ₁₂	∠S ₁₂	S ₂₂	∠S ₂₂
200	0.378	-59.9	44.381	144.9	0.011	75.9	0.839	-25.8
400	0.367	-97.7	32.694	123.1	0.017	76.8	0.668	-41.2
600	0.305	-119.0	24.123	109.2	0.022	67.7	0.543	-48.6
800	0.299	-130.2	18.968	101.2	0.025	68.9	0.486	-49.0
1000	0.303	-147.4	15.435	94.7	0.034	67.2	0.415	-47.5
1200	0.301	-153.1	13.036	88.6	0.038	65.2	0.386	-54.7
1400	0.300	-161.9	11.295	84.6	0.042	68.9	0.358	-55.0
1600	0.296	-167.4	9.936	79.9	0.048	67.2	0.352	-56.5
1800	0.294	-172.4	8.849	77.3	0.051	68.1	0.326	-54.7
2000	0.284	-179.6	7.890	73.7	0.058	65.8	0.313	-54.1
2200	0.287	176.3	7.219	71.4	0.062	64.7	0.300	-57.5
2400	0.287	171.9	6.630	68.1	0.069	65.3	0.299	-57.2
2600	0.282	167.5	6.160	65.6	0.075	60.2	0.290	-58.1
2800	0.293	162.4	5.700	62.7	0.079	62.2	0.275	-58.4
3000	0.301	157.4	5.362	59.8	0.084	59.6	0.265	-60.5
3200	0.304	153.1	5.041	57.4	0.092	60.2	0.260	-59.0
3400	0.308	149.9	4.744	54.9	0.096	55.6	0.252	-58.9
3600	0.319	146.2	4.505	52.4	0.101	56.3	0.237	-61.3
3800	0.319	143.0	4300	49.8	0.104	55.9	0.223	-61.4
4000	0.325	141.0	4.106	47.3	0.113	53.9	0.219	-65.1
4200	0.343	138.2	3.930	44.8	0.115	51.2	0.204	-67.0
4400	0.349	133.9	3.767	42.4	0.122	50.4	0.197	-67.5
4600	0.355	131.1	3.622	39.7	0.124	48.5	0.185	-70.2
4800	0.359	129.1	3.482	37.1	0.132	47.6	0.184	-73.0
5000	0.374	126.4	3.363	34.6	0.135	44.8	0.179	-73.0
5200	0.378	123.4	3.255	32.2	0.137	44.2	0.168	-75.7
5400	0.383	120.8	3.130	29.8	0.142	42.5	0.161	-82.2
5600	0.385	118.4	3.041	27.5	0.146	40.9	0.166	-85.0
5800	0.388	116.0	2.961	24.7	0.151	38.7	0.169	-86.0
6000	0.395	112.2	2.859	22.0	0.154	35.9	0.158	-88.1

SBFP540M

SPICE PARAMETERS

model : Gummel-Poon

Parameter	Value	Unit	Parameter	Value	Unit
IS	82.84a	A	TF	6.76p	S
BF	107.5		XTF	0.4219	
NF	1		VTF	0.23794	V
VAF	28.383	V	ITF	1m	A
IKF	0.48731	A	PTF	0	deg
ISE	11.15p	A	CJC	234f	F
NE	3.19		VJC	0.81969	V
BR	5.5		MJC	0.30232	
NR	1		XCJC	0.3	
VAR	19.705	V	TR	2.324n	S
IKR	0.02	A	FC	0.73234	
ISC	19.237f	A	CJS	0	F
NC	1.172		VJS	0.75	V
RB	5.4	Ω	MJS	0	
IRB	729.83 μ	A	CC	20f	F
RBM	1.3	Ω	Cbc	20f	F
RE	0.31111	Ω	Cbe	20f	F
RC	4	Ω	Lb	0.80n	H
XTB	0		Lc	0.84n	H
EG	1.11	eV	Le	1.0n	H
XTI	3				
CJE	1.8063f	F			
VJE	0.8051	V			
MJE	0.46576				

SCHEMATIC

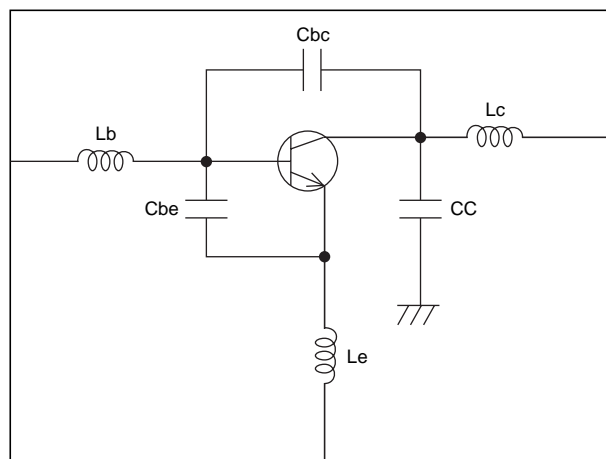

*Information (including circuit diagrams and circuit parameters) herein is for example only ; it is not guaranteed for volume production.

SBFP540M

- Specifications of any and all SANYO products described or contained herein stipulate the performance, characteristics, and functions of the described products in the independent state, and are not guarantees of the performance, characteristics, and functions of the described products as mounted in the customer's products or equipment. To verify symptoms and states that cannot be evaluated in an independent device, the customer should always evaluate and test devices mounted in the customer's products or equipment.
- SANYO Electric Co., Ltd. strives to supply high-quality high-reliability products. However, any and all semiconductor products fail with some probability. It is possible that these probabilistic failures could give rise to accidents or events that could endanger human lives, that could give rise to smoke or fire, or that could cause damage to other property. When designing equipment, adopt safety measures so that these kinds of accidents or events cannot occur. Such measures include but are not limited to protective circuits and error prevention circuits for safe design, redundant design, and structural design.
- In the event that any or all SANYO products(including technical data, services) described or contained herein are controlled under any of applicable local export control laws and regulations, such products must not be exported without obtaining the export license from the authorities concerned in accordance with the above law.
- No part of this publication may be reproduced or transmitted in any form or by any means, electronic or mechanical, including photocopying and recording, or any information storage or retrieval system, or otherwise, without the prior written permission of SANYO Electric Co., Ltd.
- Any and all information described or contained herein are subject to change without notice due to product/technology improvement, etc. When designing equipment, refer to the "Delivery Specification" for the SANYO product that you intend to use.
- Information (including circuit diagrams and circuit parameters) herein is for example only ; it is not guaranteed for volume production. SANYO believes information herein is accurate and reliable, but no guarantees are made or implied regarding its use or any infringements of intellectual property rights or other rights of third parties.

This catalog provides information as of October, 2003. Specifications and information herein are subject to change without notice.

www.DataSheet4U.com