

**High Power
BIDI® Optical Standard Module
1550 nm Emitting, 1310 nm Receiving**

SBH92344x-FSAN

Features

- Designed for application in passive-optical networks according to FSAN, ITU-T G.983
- Suitable for OLT applications, 155 Mbit/s downstream bitrate
- Integrated Wavelength Division Multiplexer (WDM)
- Bi-Directional Transmission in 2nd and 3rd optical window
- Single fiber solution
- DFB-Laser Diode with Multi-Quantum Well structure
- Class 3B Laser Product
- Suitable for bit rates up to 1.25 Gbit/s
- Ternary Photodiode at rear mirror for monitoring and control of radiant power
- Low noise / high bandwidth PIN diode
- Hermetically sealed subcomponents, similar to TO 46
- With singlemode fiber pigtail



Pin Configuration

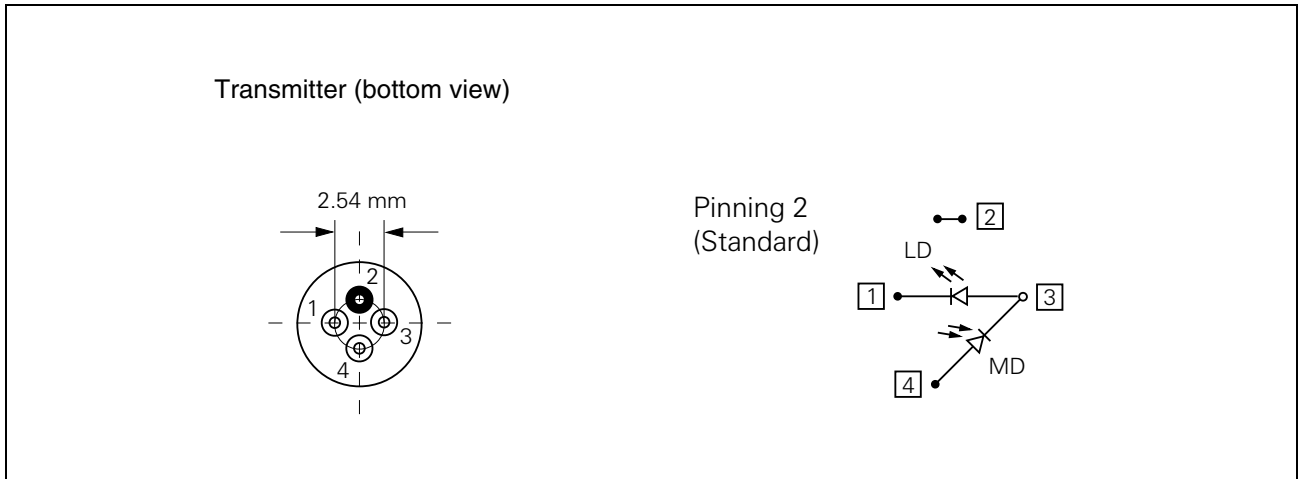

Figure 1 Transmitter

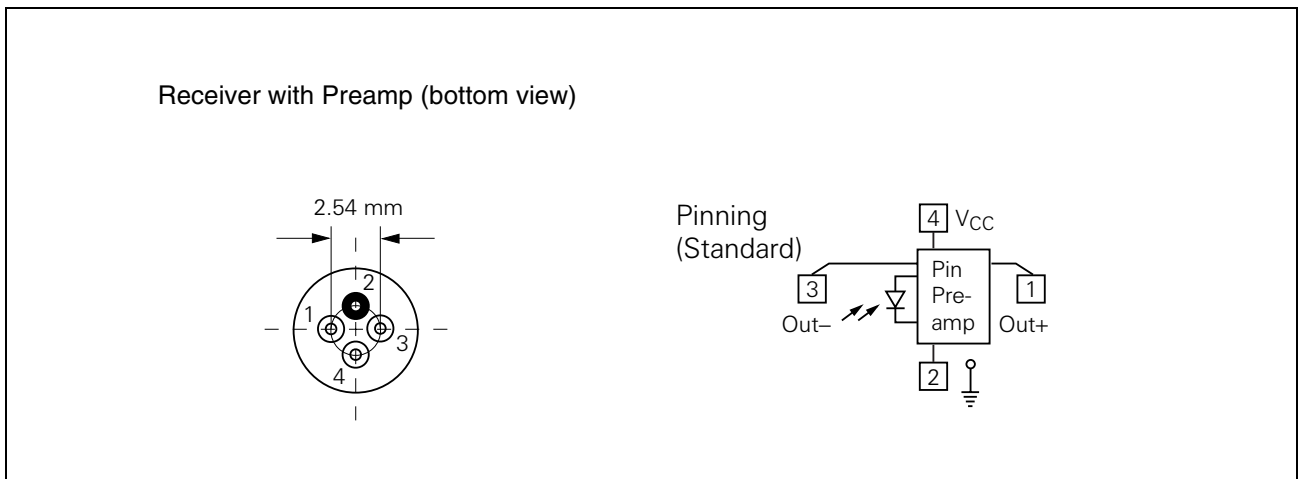

Figure 2 Receiver with Preamp

Other Pinnings on request / different drawing set required for non standard pinning

Description

The Infineon module for bidirectional optical transmission has been designed for different optical networks structures.

In the last few years the structure has changed from point to point planned for Broad band ISDN to a point to multipoint passive optical network (PON) architecture for the optical network in the subscriber loop.

A transceiver can be realized with discrete elements (**Figure 3**). Transmitter and receiver with pigtails are connected with a fiber-coupler (2:1 or 2:2, wavelength independent or WDM).

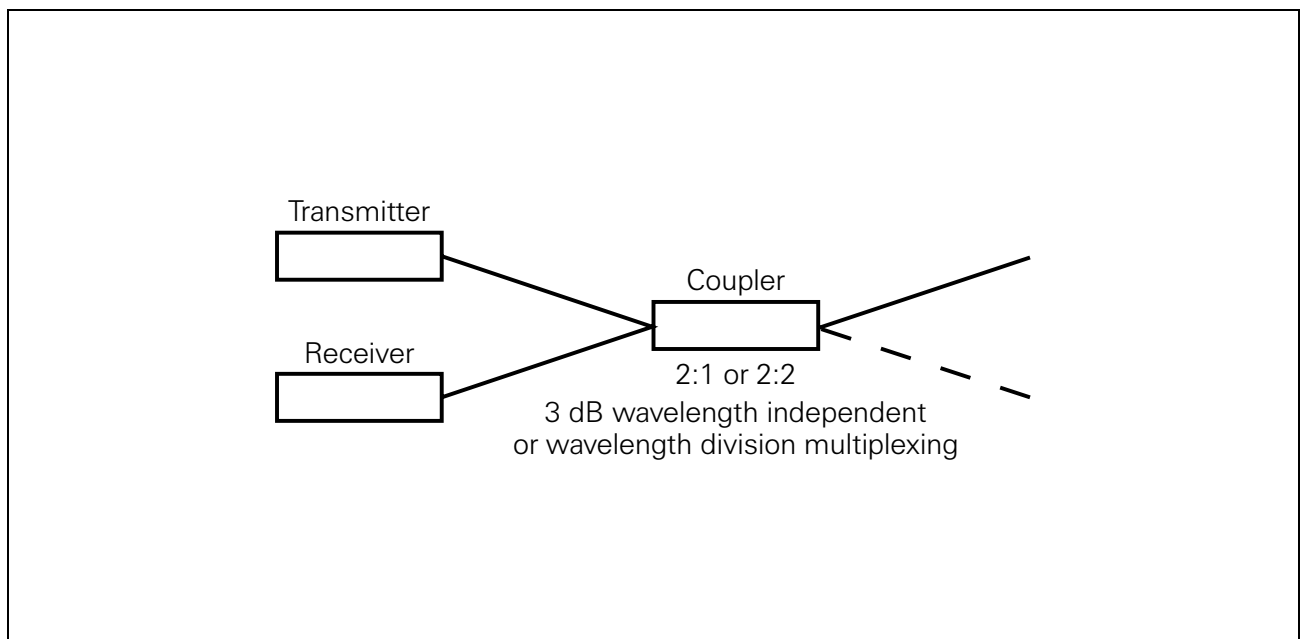

Figure 3 Realization with Discrete Elements

Infineon has realized this transceiver configuration in a compact module called a BIDI® (**Figure 4**).

This module is especially suitable for separating the opposing signals at the ends of a link. It replaces a discrete solution with a transmitter, receiver and coupler.

The basic devices are a laser diode and a photodiode, each in a TO package, plus the filter in the beam path. A lens in the TO laser concentrates the light and enables it to be launched into the single-mode fiber of the module. In the same way the light from the fiber is focused onto the small, light-sensitive area of the photodiode to produce a high photo current. The mirror for coupling out the received signal is arranged in the beam so that the transmitter and receiver are at right angles to each other. This means the greatest possible degree of freedom in the layout of the electric circuit.

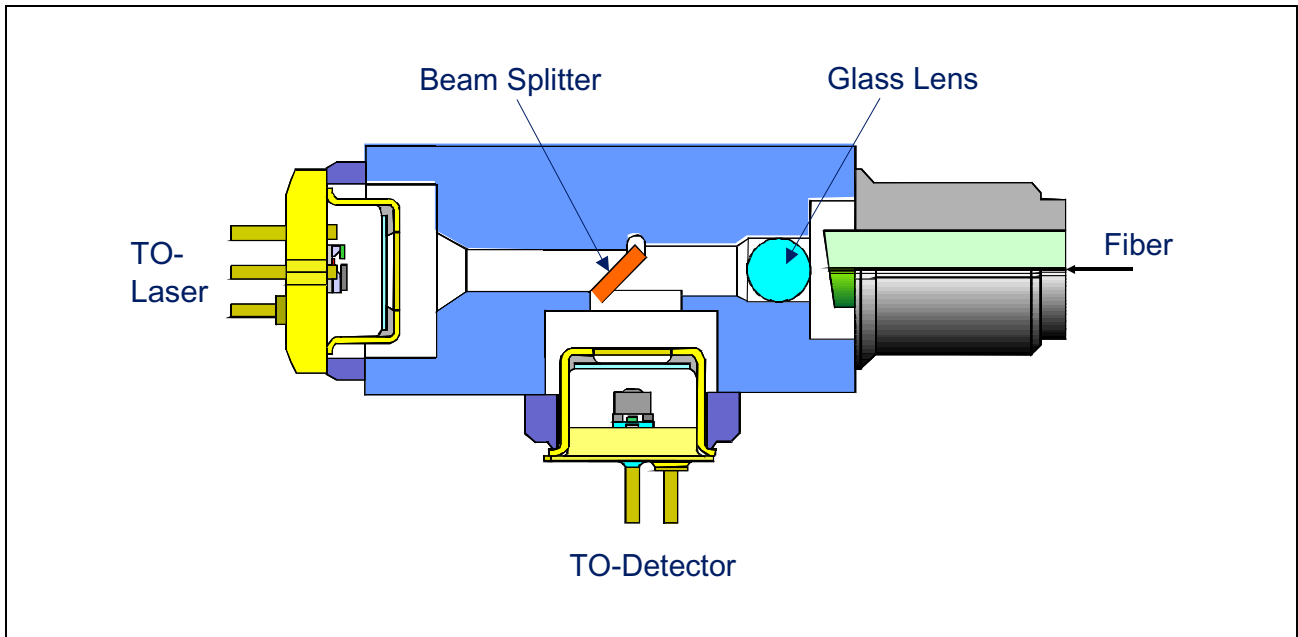

Figure 4 Compact Realization of the Transceiver in One Module

A decisive advantage of the module is its use of standard TO components. These devices, produced in large quantities, are hermetically sealed and tested before they are built in. This makes a very substantial contribution to the excellent reliability of the module. The solid metal package of the module serves the same purpose. It allows the use of modern laser welding techniques for reliable fixing of the different elements and the fiber holder.

FSAN Applications

The generation of a service-independent platform providing a high transport capacity based on the existing infrastructure is the most important goal with respect to the standardization of new systems for the access network. For FSAN (Full Service Access Network) there have been several Working Groups working on a special system configuration. The target of FSAN was to make a specification for:

- Fiber To The Cabinet (FTTCab)
- Fiber To The Curb (FTTC)
- Fiber To The Building (FTTB)
- Fiber To The Home (FTTH).

The FSAN Basic Network Structure is shown below.

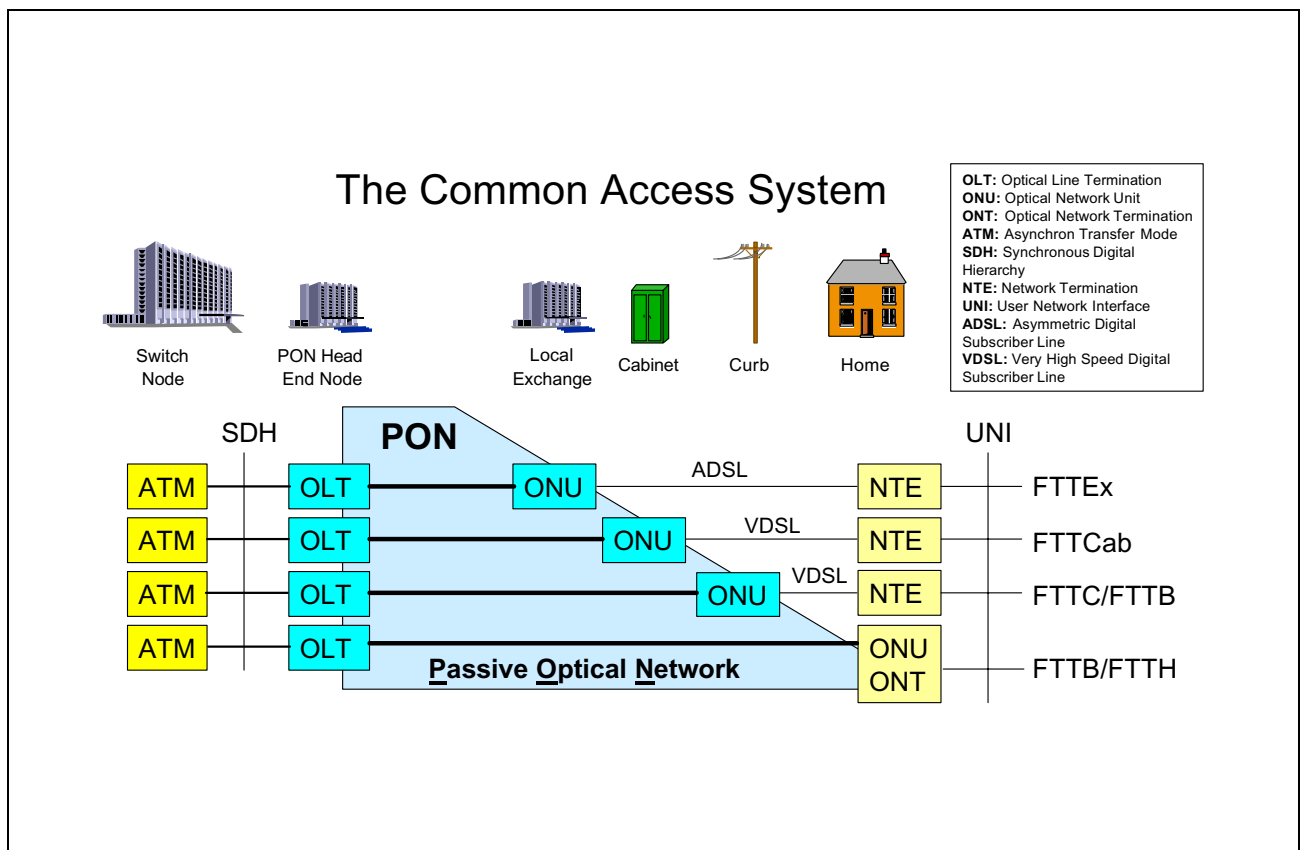

Figure 5 FSAN Basic Network Structure

Technical Data
Absolute Maximum Ratings

Parameter	Symbol	Limit Values		Unit
		min.	max.	

Module

Operating temperature range at case	T_C	0	70	°C
Storage temperature range	T_{stg}	-40	85	
Soldering temperature ($t_{max} = 10$ s, 2 mm distance from bottom edge of case)	T_S		260	

Laser Diode

Direct forward current	$I_{F\ max}$		120	mA
Radiant power CW	$P_{F, rad}$		4	mW
Reverse Voltage	V_R		2	V

Monitor Diode

Reverse Voltage	V_R		10	V
Forward Current	I_F		2	mA

Receiver Diode

Reverse Voltage	V_R		10	V
Forward Current	I_F		2	mA
Optical power into the optical port	P_{port}		3	mW

Technical Data

The electro-optical characteristics described in the following tables are only valid for use within the specified maximum ratings or under the recommended operating conditions.

Transmitter Electro-Optical Characteristics

Parameter	Symbol	Limit Values			Unit
		min.	typ.	max.	
Optical output power (maximum)	$P_{F, \max}$	2			mW
Emission wavelength center of range, $P_F = 0.5 P_{F, \max}$.	λ_{trans}	1480		1580	nm
Spectral width (RMS)	σ_λ			0.1	
Temperature coefficient of wavelength	TC			0.15	nm/K
Threshold current (whole temperature range)	I_{th}	2		55	mA
Forward voltage, $P_F = 0.5 P_{F, \max}$.	V_F			1.5	V
Radiant power at I_{th}	P_{th}			50	μW
Slope efficiency (0...70°C)	η	35		150	mW/A
Variation of 1st derivative of P/I (0.1 to 2.0 mW)	S_{var}	-30		30	%
Differential series resistance	R_S			8	Ω
Rise time (10%–90%)	t_r		100	200	ps
Fall time (10%–90%)	t_f		270	500	

Monitor Diode Electro-Optical Characteristics

Parameter	Symbol	Limit Values		Unit
		min.	max.	
Dark current, $V_R = 5 \text{ V}$, $P_F = 0$, $T = T_{\max}$	I_R		500	nA
Photocurrent, $V_R = 5 \text{ V}$, $P_F = 0.5 P_{F, \max}$	I_P	100	1000	μA
Capacitance, $V_R = 5 \text{ V}$, $f = 1 \text{ MHz}$	C_5		10	pF
Tracking error ¹⁾ , $V_R = 5 \text{ V}$	TE	-1	1	dB

¹⁾ The tracking error TE is the maximum deviation of P_F at constant current I_{mon} over a specified temperature range and relative to the reference point: $I_{\text{mon, ref}} = I_{\text{mon}} (T = 25^\circ\text{C}, P_F = 0.5 P_{F, \max})$. Thus, TE is given by:

$$\text{TE}[\text{dB}] = 10 \times \log \frac{P_F[T_C]}{P_F[25^\circ\text{C}]}$$

Receiver Diode Electro-Optical Characteristics

Parameter	Symbol	Limit Values		Unit
		min.	max.	
Spectral sensitivity, $V_R = 5\text{ V}$, $\lambda = 1310\text{ nm}$	S_{rec}	0.65	1	A/W
Rise and fall time (10%–90%) $R_L = 50\ \Omega$, $V_R = 5\text{ V}$	t_r ; t_f		0.5	ns
Total capacitance $V_R = 5\text{ V}$, $P_{\text{opt}} = 0$, $f = 1\text{ MHz}$	C		1.5	pF
Dark current, $V_R = 5\text{ V}$, $P_{\text{opt}} = 0$	I_D		50	nA

Characteristics for Pin-Preamp-Receivers at $T_A = 25^\circ\text{C}$, unless otherwise specified.

Preamp Characteristics

Parameter	Symbol	Limit Values			Unit
		min.	typ.	max.	

DC-Characteristics

Supply Voltage	V_{CC}	4.5	5	6	V
Supply Current	I_{CC}		25	26	mA

AC-Characteristics

Optical Sensitivity (BER $\leq 10^{-10}$, PN7)	S	-33	-36		dBm
Linear Bandwidth (-3 dB)	BW	180	240		MHz
Optical overload (average)	P_{max}	-7	-5		dBm
Transimpedance (single ended)	R_T	8	10	12	k Ω
Output resistance (single ended)	R_{out}	40	50	60	Ω
Noise current density			3		pa/ $\sqrt{\text{Hz}}$
Gain (differential)	G	10	16	24	mV/ μW

Module Electro-Optical Characteristics

Parameter	Symbol	Limit Values		Unit
		min.	max.	
Optical Crosstalk ¹⁾	CRT		-47	dB
Backreflection (Return Loss) 1310 nm	RL		-20	
Backreflection (Return Loss) 1550 nm				

¹⁾ Optical Crosstalk is defined as

$$\text{CRT}[\text{dB}] = 10 \times \log \frac{I_{\text{Det},0}}{I_{\text{Det},1}}$$

with: $I_{\text{Det},0}$: the photocurrent with $P_F = 0.5 P_{F, \text{max.}}$, without optical input, CW laser operation, $V_R = 2 \text{ V}$ and $I_{\text{Det},1}$: the photocurrent without P_F , but $0.5 P_{F, \text{max.}}$ optical input power, $\lambda = 1310 \text{ nm}$.

End of Life Time Characteristics

Parameter	Symbol	Limit Values		Unit
		min.	max.	
Threshold current at $T = T_{\text{max}}$	I_{th}		60	mA
Current above threshold, over full temperature range, at $I_{\text{mon, ref}} = I_{\text{mon}}$ ($T = 25^\circ\text{C}$, $P_F = 0.5 P_{F, \text{max.}}$, BOL)	ΔI_F	7	70	
Tracking Error	TE	-1.5	1.5	dB
Detector Dark Current, $V_R = 2 \text{ V}$, $T = T_{\text{max}}$	I_R		400	nA
Monitor Dark Current, $V_R = 2 \text{ V}$, $T = T_{\text{max}}$	I_R		1	μA

Fiber Data

The mechanical fiber characteristics are described in the following table.

Fiber Characteristics

Parameter	Limit Values			Unit
	min.	typ.	max.	
Mode Field Diameter	8	9	10	μm
Cladding Diameter	123	125	127	
Mode Field/Cladding Concentricity Error			1	
Cladding Non-circularity			2	%
Mode Field Non-circularity			6	
Cut off Wavelength	1270			nm
Jacket Diameter	0.8		1	mm
Bending Radius	30			
Tensile Strength Fiber Case	5			N
Length	0.8		1.2	m

Eye Safety

Ensure to avoid exposure of human eyes to high power laser diode emitted laser beams. Especially do not look directly into the laser diode or the collimated laser beam when the diode is activated.

Class 3B Laser Product According to IEC 60825-1

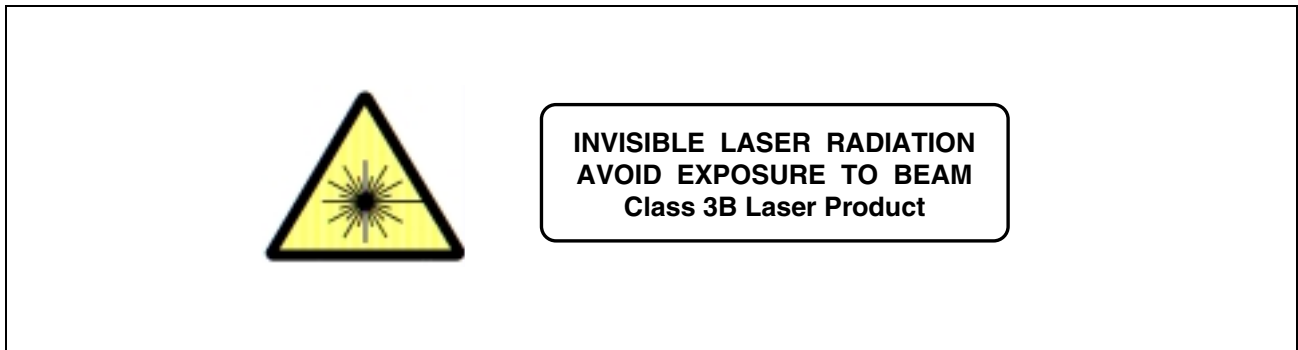

Figure 6 Required Labels

Class IIIb Laser Product According to FDA Regulations Complies with 21 CFR 1040.10 and 1040.11



Figure 7 Required Label

Laser Data

Wavelength	1550 nm
Maximum total output power	less than 50 mW
Beam divergence (1/e ²)	10°

Package Outlines

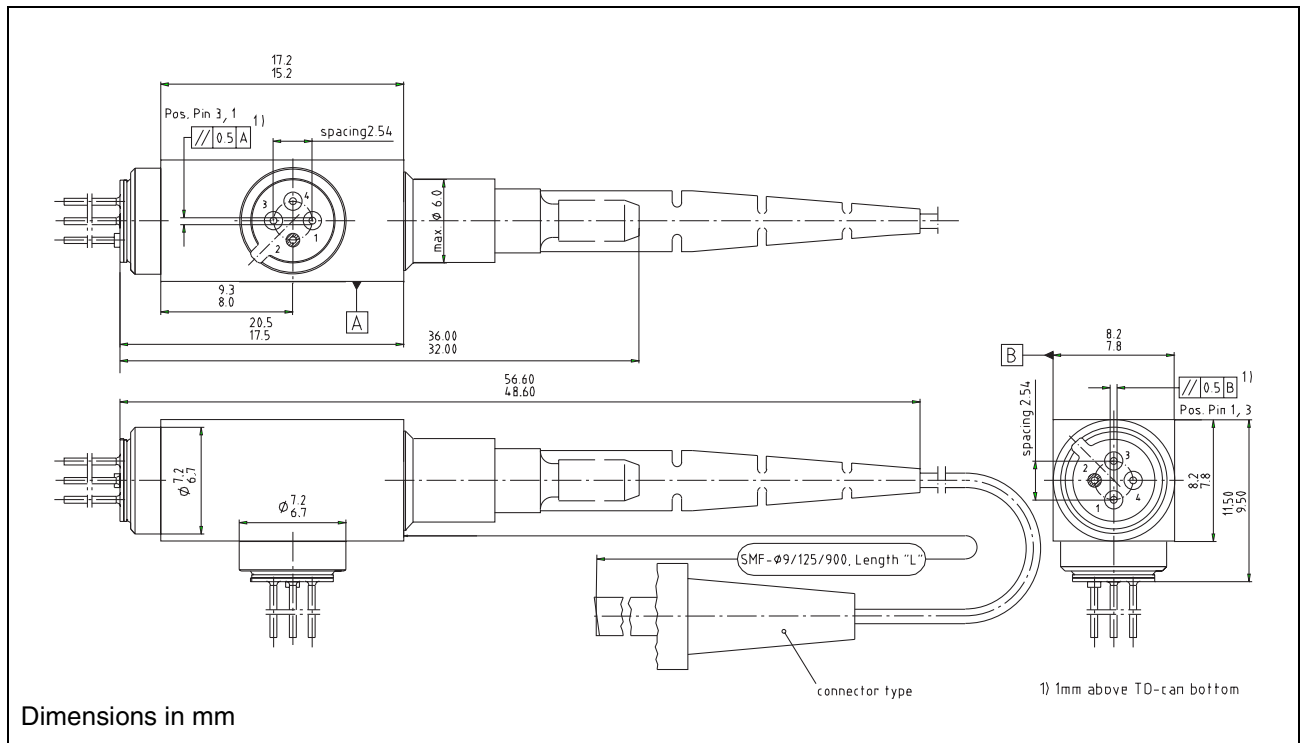

Figure 8

Connector Options

Model	Type
SBH92344G-FSAN	SM FC/PC
SBH92344N-FSAN	SM SC/PC 0°
SBH92344P-FSAN	SM SC/APC 8°
SBH92344Z-FSAN	SM without connector

Other connectors on request

SBH92344x-FSAN

Revision History: **2002-05-28**

DS0

Previous Version:

Page	Subjects (major changes since last revision)
	Document's layout has been changed: 2002-Aug.

For questions on technology, delivery and prices please contact the Infineon Technologies Offices in Germany or the Infineon Technologies Companies and Representatives worldwide: see our webpage at <http://www.infineon.com>.

Edition 2002-05-28

**Published by Infineon Technologies AG,
St.-Martin-Strasse 53,
D-81541 München, Germany**

**© Infineon Technologies AG 2002.
All Rights Reserved.**

Attention please!

The information herein is given to describe certain components and shall not be considered as warranted characteristics.

Terms of delivery and rights to technical change reserved.

We hereby disclaim any and all warranties, including but not limited to warranties of non-infringement, regarding circuits, descriptions and charts stated herein.

Infineon Technologies is an approved CECC manufacturer.

Information

For further information on technology, delivery terms and conditions and prices please contact your nearest Infineon Technologies Office in Germany or our Infineon Technologies Representatives worldwide.

Warnings

Due to technical requirements components may contain dangerous substances. For information on the types in question please contact your nearest Infineon Technologies Office.

Infineon Technologies Components may only be used in life-support devices or systems with the express written approval of Infineon Technologies, if a failure of such components can reasonably be expected to cause the failure of that life-support device or system, or to affect the safety or effectiveness of that device or system. Life-support devices or systems are intended to be implanted in the human body, or to support and/or maintain and sustain and/or protect human life. If they fail, it is reasonable to assume that the health of the user or other persons may be endangered.