

STANLEY SUPER BRIGHT LED LAMP

φ5(T-1 3/4)TYPE

5603

5613

5623

5633

SERIES



SELECTION GUIDE

COLOR	MATERIAL	PART NUMBER
Red	GaAlAs	(E)SBR 5603, 5623 5613, 5633
	GaAsP	SAR 5603, 5623 5613, 5633
	GaP	SPR 5603, 5623 5613, 5633
Green	GaP	(E)SBG 5603, 5623 5613, 5633
	GaP	SPG 5623 5633
Yellow	GaP	(E)SPY 5603, 5623 5613, 5633
	GaAsP/GaP	(E)SAY 5603, 5623 5613, 5633
Orange	GaAsP/GaP	(E)SAA 5603, 5623 5613, 5633

FEATURES

- AVAILABLE IN 4 COLORS; RED, GREEN, YELLOW AND ORANGE
- LOW DOME WITH 5mm DIA, 6.0mm HIGHT
- AVAILABLE IN WIDE VIEWING ANGLE
- LOW CURRENT DRIVE, DIRECTLY COMPATIBLE WITH IC
- QUICK RESPONSE, ALLOWING PULSED OPERATION
- HIGH RELIABILITY

DESCRIPTION

Low dome type LED series are available in standard types using chip materials of GaAsP and GaP and super bright types using chip materials of GaAlAs, GaP and GaAsP/GaP. Low dome LEDs are most suitable for the use requiring wide range illumination in limited space.

Package Dimensions—Unit in mm

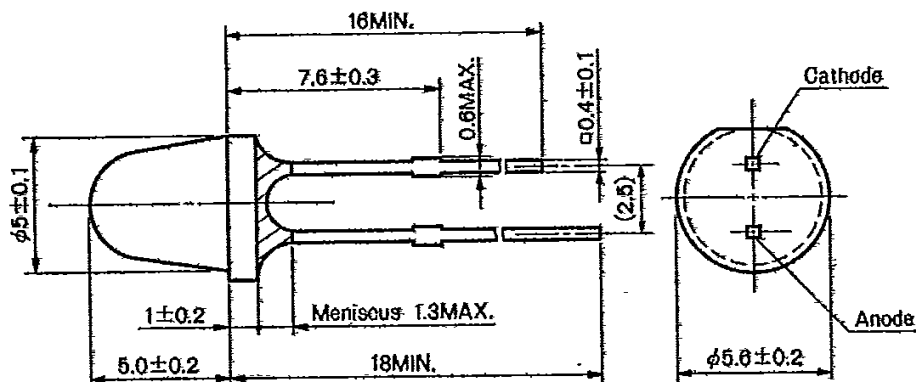

Absolute Maximum Ratings (Ta=25°C)

Parameter	Symbol	Red			Green		Yellow		Orange	Units
		BR	AR	PR	BG	PG	PY	AY	AA	
Forward Current	I _F	50	50	30	50	50	50	50	50	mA
Peak Forward Current	I _{FM}	300	300	100	100	100	100	100	100	mA
Reverse Voltage	V _R	4			4		4		4	V
Power Dissipation	P _d	100	100	75	125	125	125	125	125	mW
Operating Temperature	Topr	-30~+85			-30~+85		-30~+85		-30~+85	°C
Storage Temperature	Tstg	-30~+100			-30~+100		-30~+100		-30~+100	°C
Lead Soldering Temperature		260°C for 5 seconds (3.0mm from body)								

Electro-Optical Characteristics (Ta=25°C)

Type No.	Chip		Lens	I _v (mcd)		at I _F (mA)	Peak Wave Length λ _p (nm)	Spectral Line Half Width Δλ(nm)	V _E (V)		at I _F (mA)	at V _R 4V I _R (μA)	Capacitance Co(pF)
	Material	Emitted Color		Min.	Typ.				Typ.	Max.			
SBR5603(23)	GaAlAs	Red	W.C (C.C)	15.0	30.0	20	660	30	1.7	2.0	20	100	50
5633(13)	GaAlAs	Red	C.D (W.D)	8.0	20.0	20	660	30	1.7	2.0	20	100	50
ESBR5603(23)	GaAlAs	Red	W.C (C.C)	30.0	60.0	20	660	30	1.7	2.0	20	100	50
5633(13)	GaAlAs	Red	C.D (W.D)	20.0	30.0	20	660	30	1.7	2.0	20	100	50
SAR5603(23)	GaAsP	Red	W.C (C.C)	2.5	5.0	20	650	30	1.7	2.0	20	100	40
5633(13)	GaAsP	Red	C.D (W.D)	1.5	3.0	20	650	30	1.7	2.0	20	100	40
SPR5603(23)	GaP	Red	W.C (C.C)	4.0	8.0	10	700	100	2.1	2.5	10	100	70
5633(13)	GaP	Red	C.D (W.D)	2.5	5.0	10	700	100	2.1	2.5	10	100	70
SBG5603(23)	GaP	Green	W.C (C.C)	8.0	16.0	20	555	30	2.1	2.5	20	100	50
5633(13)	GaP	Green	C.D (W.D)	4.0	8.0	20	555	30	2.1	2.5	20	100	50
ESBG5603(23)	GaP	Green	W.C (C.C)	16.0	24.0	20	555	30	2.1	2.5	20	100	50
5633(13)	GaP	Green	C.D (W.D)	8.0	12.0	20	555	30	2.1	2.5	20	100	50
SPG5623	GaP	Green	C.C	18.0	36.0	20	565	30	2.1	2.5	20	100	40
5633	GaP	Green	C.D	12.0	24.0	20	565	30	2.1	2.5	20	100	40
SPY5603(23)	GaP	Yellow	W.C (C.C)	25.0	50.0	20	570	30	2.1	2.5	20	100	40
5633(13)	GaP	Yellow	C.D (W.D)	15.0	30.0	20	570	30	2.1	2.5	20	100	40
ESPY5603(23)	GaP	Yellow	W.C (C.C)	50.0	75.0	20	570	30	2.1	2.5	20	100	40
5633(13)	GaP	Yellow	C.D (W.D)	30.0	45.0	20	570	30	2.1	2.5	20	100	40
SAY5603(23)	GaAsP/GaP	Yellow	W.C (C.C)	15.0	30.0	20	580	30	2.2	2.5	20	100	40
5633(13)	GaAsP/GaP	Yellow	C.D (W.D)	8.0	20.0	20	580	30	2.2	2.5	20	100	40
ESAY5603(23)	GaAsP/GaP	Yellow	W.C (C.C)	30.0	45.0	20	580	30	2.2	2.5	20	100	40
5633(13)	GaAsP/GaP	Yellow	C.D (W.D)	20.0	30.0	20	580	30	2.2	2.5	20	100	40
SAA5603(23)	GaAsP/GaP	Orange	W.C (C.C)	15.0	30.0	20	605	30	2.2	2.5	20	100	50
5633(13)	GaAsP/GaP	Orange	C.D (W.D)	8.0	20.0	20	605	30	2.2	2.5	20	100	50
ESAA5603(23)	GaAsP/GaP	Orange	W.C (C.C)	30.0	45.0	20	605	30	2.2	2.5	20	100	50
5633(13)	GaAsP/GaP	Orange	C.D (W.D)	20.0	30.0	20	605	30	2.2	2.5	20	100	50

SPATIAL DISTRIBUTION

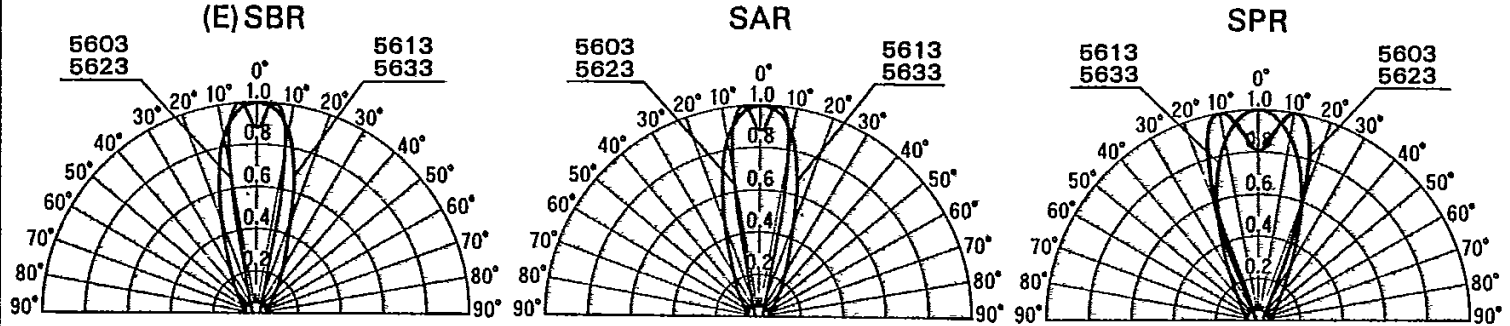

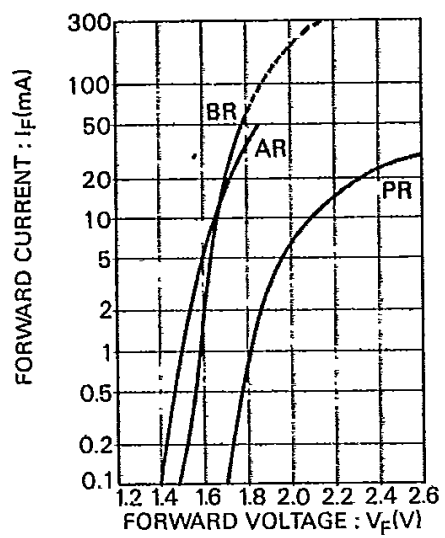

FORWARD CURRENT vs. FORWARD VOLTAGE

RATIO OF MAXIMUM TOLERABLE PEAK CURRENT TO MAXIMUM TOLERABLE DC CURRENT

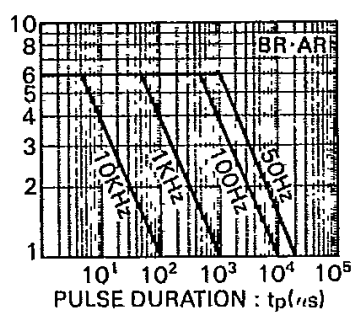

MAXIMUM TOLERABLE PEAK CURRENT vs. PULSE DURATION

RATIO OF MAXIMUM TOLERABLE PEAK CURRENT TO MAXIMUM TOLERABLE DC CURRENT

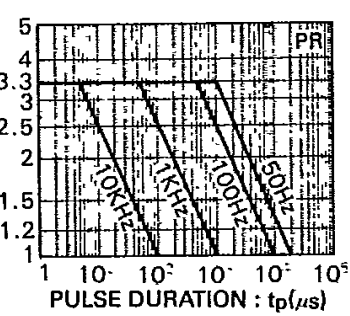

$I_{F,AK} \text{ MAX.}$
 $I_{DC} \text{ MAX.}$

MAXIMUM TOLERABLE PEAK CURRENT vs. PULSE DURATION

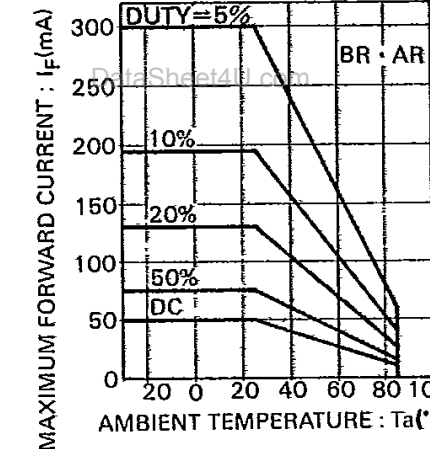

MAXIMUM FORWARD CURRENT vs. AMBIENT TEMPERATURE

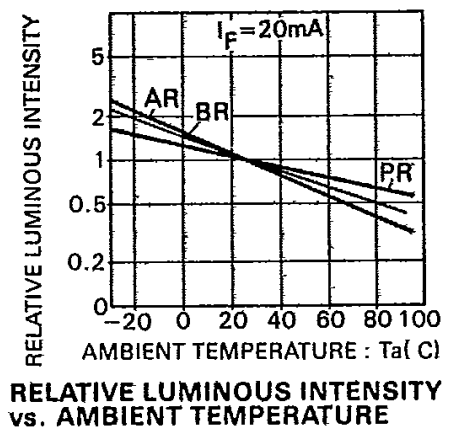

RELATIVE LUMINOUS INTENSITY vs. AMBIENT TEMPERATURE

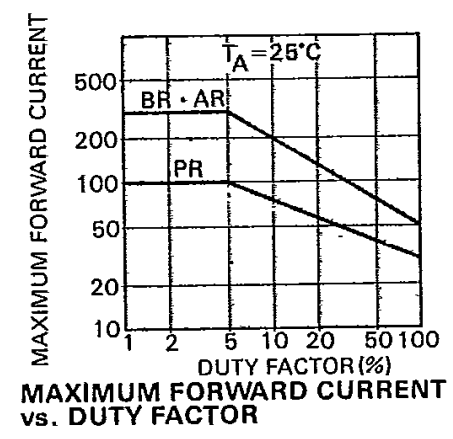

MAXIMUM FORWARD CURRENT vs. DUTY FACTOR

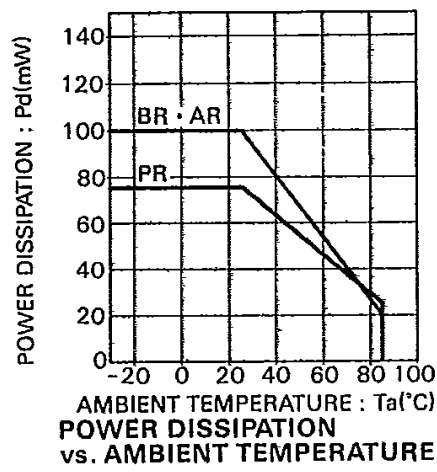

POWER DISSIPATION vs. AMBIENT TEMPERATURE

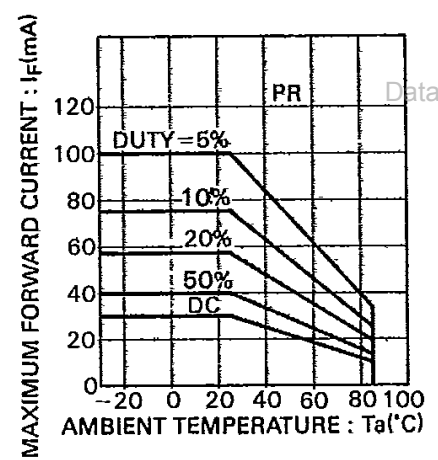

MAXIMUM FORWARD CURRENT vs. AMBIENT TEMPERATURE

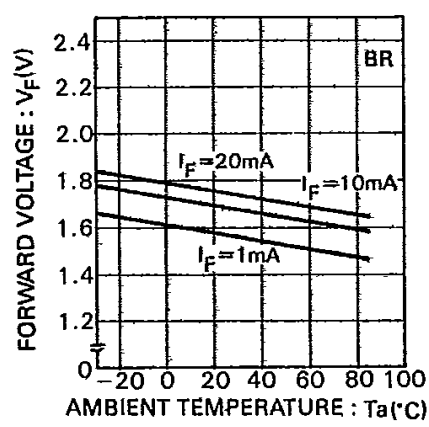

FORWARD VOLTAGE vs. AMBIENT TEMPERATURE

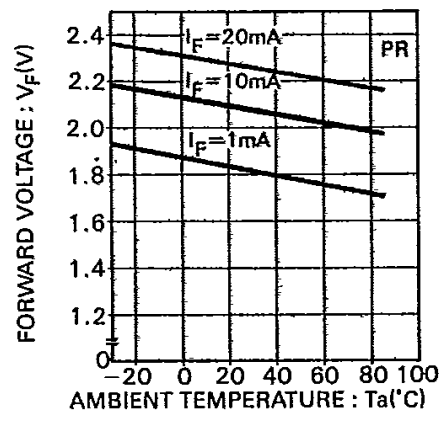
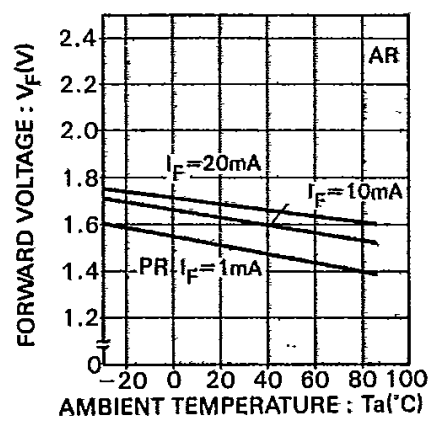

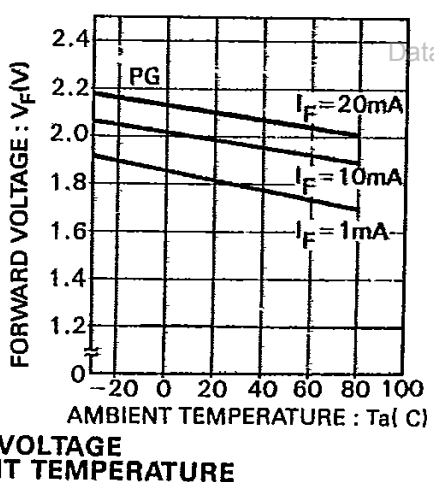
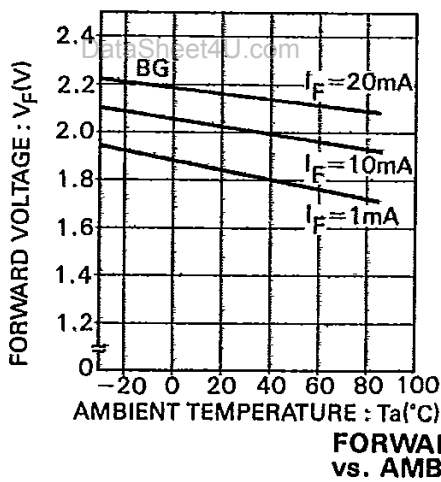
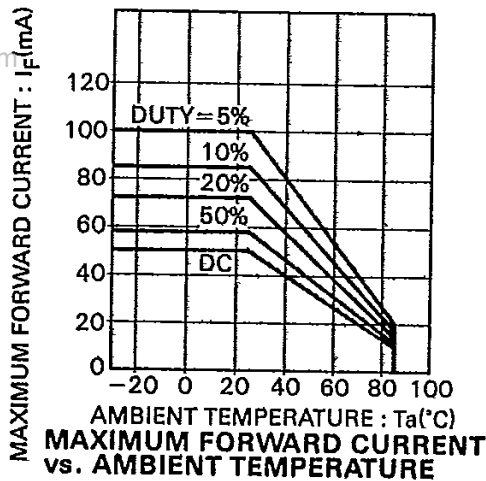
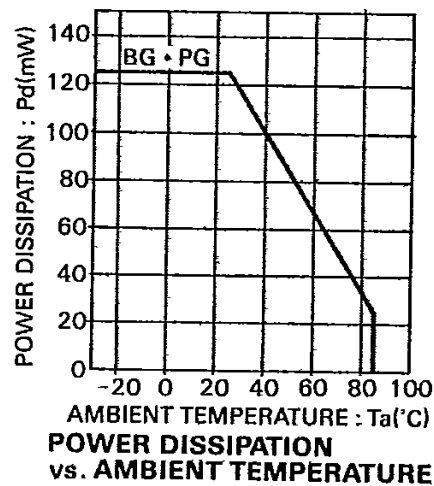
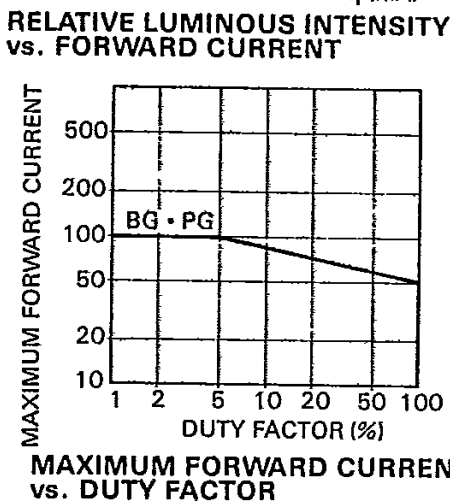
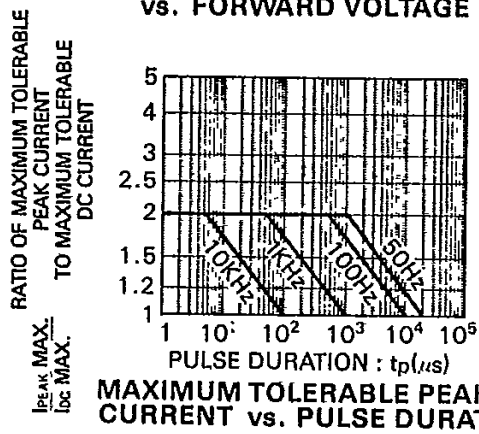
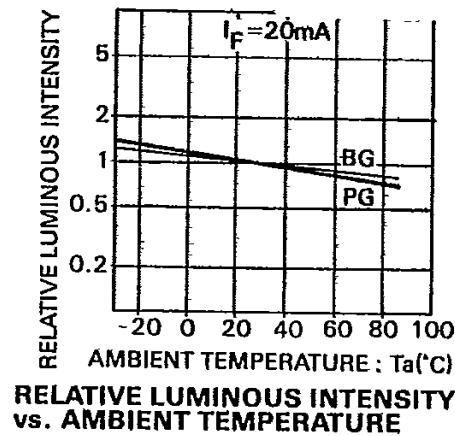
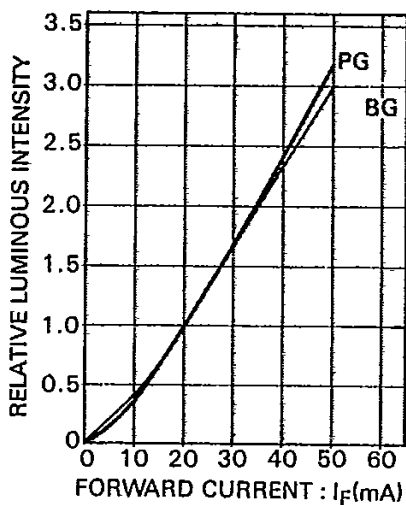
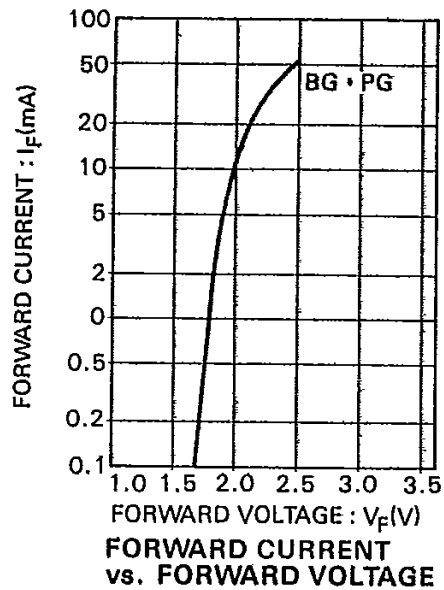

SPATIAL DISTRIBUTION

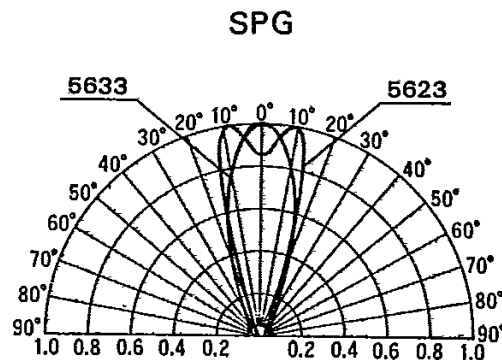
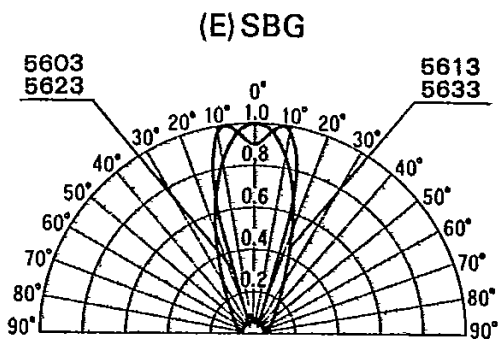

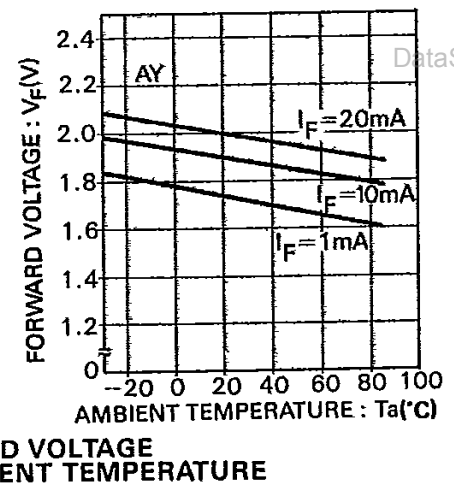
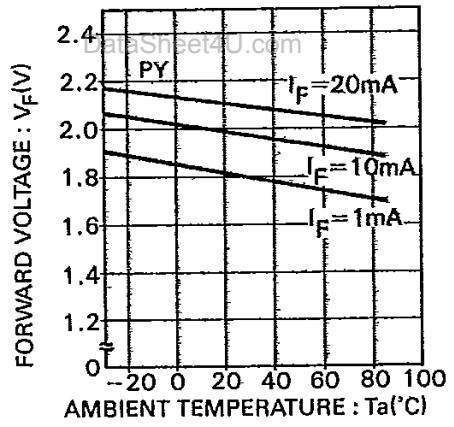
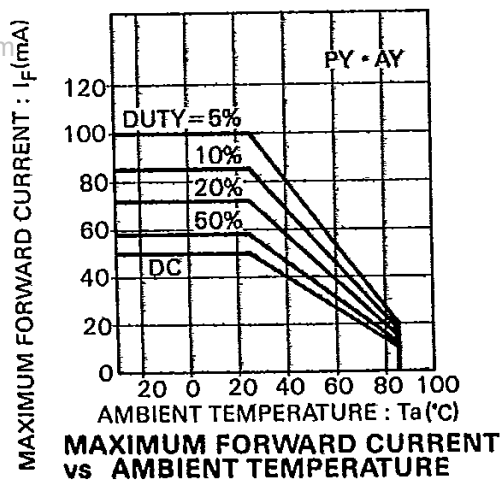
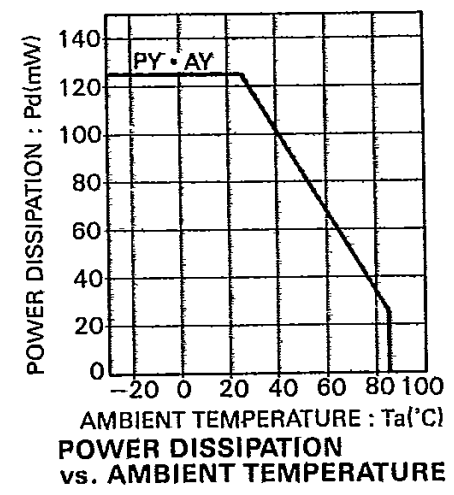
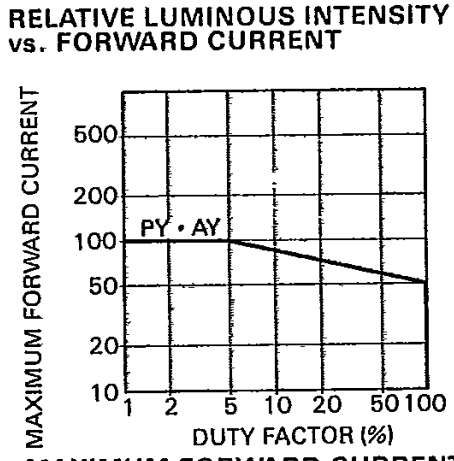
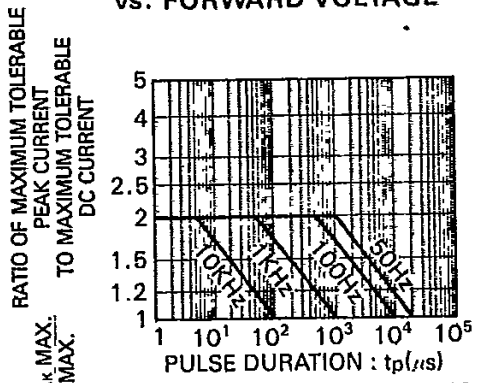
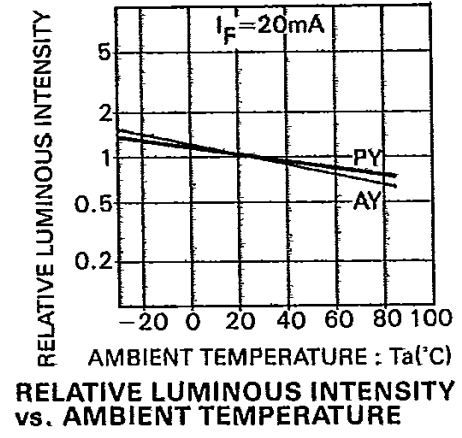
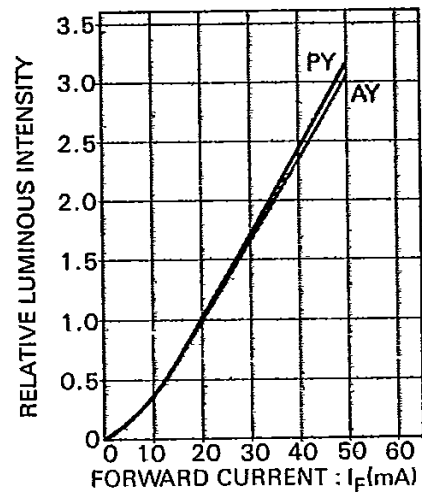
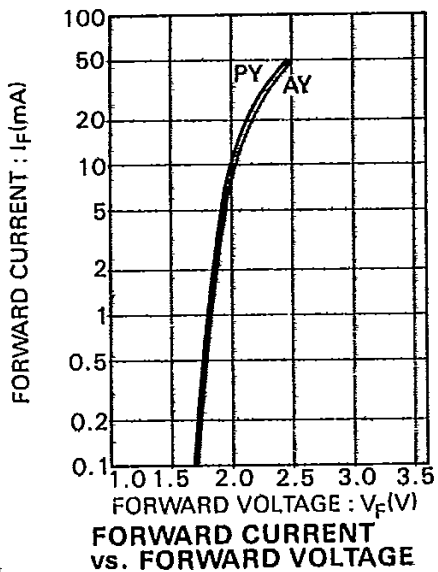

SPATIAL DISTRIBUTION

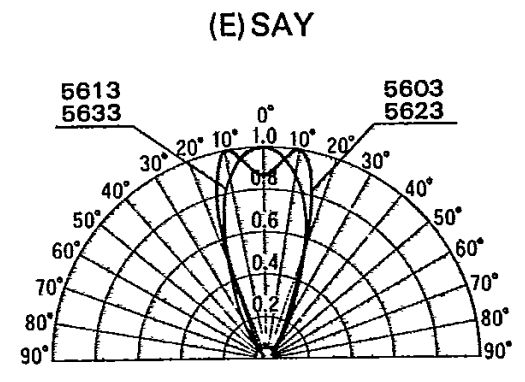
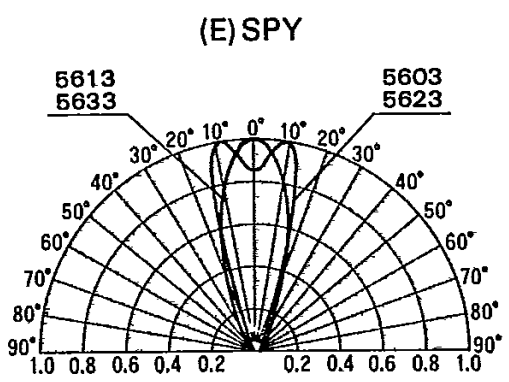

ORANGE

