

www.DataSheet4U.com

Multilayer Ferrite Chip Beads

SB/PB/UP/NB/GB Series

[SB Series for General Purpose / PB Series for Large Current/UP Series for Ultra High Current Use/NB Series for Data Line, Digital Signals, etc./GB Series for Medium Current]



OUTLINE

Yageo offers hundreds of multi-layered ferrite chip beads with various sizes, frequency characteristics, and a board range of impedance values to provide powerful solutions for EMI problems.

Three formulas of ferrite comprise several types of EMI suppression chip beads that are classified into 5 categories - SB, GB, PB, UP, and NB series.

PRODUCT IDENTIFICATION

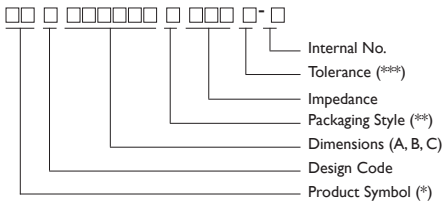

* SB, PB, UP, NB, GB
** T :Tape and Reel; B : Bulk
*** Y = ±25%; M = ±20%

■ YAGEO will start to release lead-free that meet SONY SS-00259's criteria, and Internal No. will be changed to "N" as identification.

Ex. SBY100505T-121Y-N

SHAPES AND DIMENSIONS

Dimensions : mm

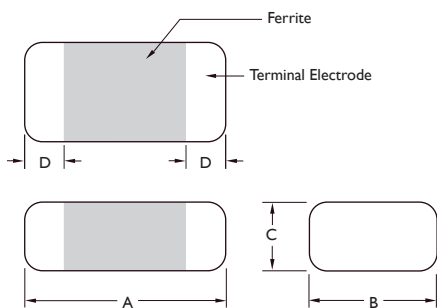

TYPE		A	B	C	D
SB/PB/NB	100505	1.0 ± 0.10	0.50 ± 0.10	0.5 ± 0.10	0.25 ± 0.10
SB/PB/UP/NB/GB	160808	1.6 ± 0.20	0.80 ± 0.2	0.8 ± 0.2	0.3 ± 0.2
SB/PB/UP/NB/GB	201209	2.0 ± 0.20	1.25 ± 0.20	0.9 ± 0.20	0.5 ± 0.3
SB/PB/UP/NB/GB	321611	3.2 ± 0.20	1.60 ± 0.20	1.1 ± 0.20	0.5 ± 0.3
SB/GB	321616	3.2 ± 0.20	1.60 ± 0.20	1.6 ± 0.20	0.5 ± 0.3
SB/GB	322513	3.2 ± 0.20	2.50 ± 0.20	1.3 ± 0.20	0.5 ± 0.3
SB/PB/GB	451616	4.5 ± 0.25	1.60 ± 0.20	1.6 ± 0.20	0.5 ± 0.3
SB/PB/GB	453215	4.5 ± 0.25	3.20 ± 0.20	1.5 ± 0.20	0.5 ± 0.3



SB SERIES, FOR GENERAL USE

APPLICATIONS

I/O Ports, DC Power Lines, and Signal Lines

Computer and Peripheral Products

Consumer Electronic Products

FEATURES

Standard type used to suppress lower-frequency, lower current signals.

Impedance over a Broad Frequency Range

Suitable for Flow and Reflow Soldering

Available in 8 Sizes

ELECTRICAL CHARACTERISTICS

PART NO.	IMPEDANCE at 100MHz ($\Omega \pm 25\%$)	DC RESISTANCE (Ω) Max.	RATED CURRENT (mA) Max.	PART NO.	IMPEDANCE at 100MHz ($\Omega \pm 25\%$)	DC RESISTANCE (Ω) Max.	RATED CURRENT (mA) Max.
SBY100505T-060Y-S	6	0.05	500	SBK201209T-751Y-S	750	0.50	200
SBY100505T-100Y-S	10	0.05	500	SBK201209T-102Y-S	1000	0.50	200
SBY100505T-400Y-S	40	0.30	300	SBK201209T-152Y-S	1500	0.60	200
SBY100505T-800Y-S	80	0.40	200	SBK201209T-202Y-S	2000	0.80	100
SBY100505T-121Y-S	120	0.50	200	SBK201209T-222Y-S	2200	1.00	100
SBY100505T-241Y-S	240	0.50	200	SBK201209T-252Y-S	2500	1.00	100
SBY100505T-481Y-S	480	0.80	200	SBK201209T-272Y-S	2700	1.50	100
SBY100505T-601Y-S	600	1.00	200	SBY321611T-190Y-S	19	0.05	600
SBY100505T-102Y-S	1000	1.50	100	SBY321611T-260Y-S	26	0.05	600
SBY100505T-152Y-S	1500	2.00	60	SBY321611T-320Y-S	32	0.05	600
SBK160808T-110Y-S	11	0.05	500	SBY321611T-500Y-S	50	0.10	500
SBK160808T-190Y-S	19	0.08	500	SBY321611T-600Y-S	60	0.10	500
SBK160808T-300Y-S	30	0.10	400	SBK321611T-700Y-S	70	0.10	500
SBK160808T-400Y-S	40	0.10	400	SBK321611T-900Y-S	90	0.15	500
SBK160808T-600Y-S	60	0.10	300	SBK321611T-121Y-S	120	0.15	500
SBK160808T-800Y-S	80	0.15	300	SBK321611T-151Y-S	150	0.15	500
SBK160808T-121Y-S	120	0.25	300	SBK321611T-201Y-S	200	0.20	400
SBK160808T-221Y-S	220	0.30	200	SBK321611T-401Y-S	400	0.20	400
SBK160808T-301Y-S	300	0.40	200	SBK321611T-501Y-S	500	0.20	400
SBK160808T-451Y-S	450	0.50	200	SBK321611T-601Y-S	600	0.30	400
SBK160808T-601Y-S	600	0.50	200	SBK321611T-102Y-S	1000 *	0.40	200
SBK160808T-751Y-S	750	0.70	200	SBK321611T-122Y-S	1200 *	0.40	200
SBK160808T-102Y-S	1000	0.70	200	SBK321611T-152Y-S	1500 *	0.45	200
SBK160808T-152Y-S	1500	1.00	50	SBK321611T-202Y-S	2000 **	0.60	200
SBK160808T-222Y-S	2200	1.20	50	SBK321611T-272Y-S	2700 **	0.60	200
SBK160808T-272Y-S	2700	1.30	50	SBY321616T-250Y-S	25	0.10	500
SBY201209T-070Y-S	7	0.10	600	SBY321616T-600Y-S	60	0.20	500
SBY201209T-090Y-S	9	0.10	600	SBK321616T-700Y-S	70	0.20	500
SBY201209T-110Y-S	11	0.10	600	SBY322513T-320Y-S	32	0.20	500
SBY201209T-170Y-S	17	0.10	600	SBY322513T-600Y-S	60	0.20	500
SBY201209T-320Y-S	32	0.10	600	SBY322513T-900Y-S	90	0.20	500
SBK201209T-600Y-S	60	0.15	500	SBY451616T-500Y-S	50	0.20	600
SBK201209T-700Y-S	70	0.15	500	SBY451616T-600Y-S	60	0.20	600
SBK201209T-800Y-S	80	0.15	500	SBY451616T-800Y-S	80	0.20	600
SBK201209T-121Y-S	120	0.25	300	SBY451616T-101Y-S	100	0.30	500
SBK201209T-151Y-S	150	0.25	300	SBK451616T-151Y-S	150	0.30	500
SBK201209T-221Y-S	220	0.30	300	SBK451616T-171Y-S	170	0.30	500
SBK201209T-301Y-S	300	0.30	300	SBY453215T-700Y-S	70	0.30	500
SBK201209T-401Y-S	400	0.30	300	SBY453215T-121Y-S	120	0.30	500
SBK201209T-501Y-S	500	0.40	300				
SBK201209T-601Y-S	600	0.40	300				

Note : * at 50MHz

** at 30MHz



LEAD-FREE & ROHS COMPLIANCE

PART NO.	IMPEDANCE	RDC	RATED CURRENT	PART NO.	IMPEDANCE	RDC	RATED CURRENT
	($\Omega \pm 25\%$)	(Ω) Max.	(mA) Max.		($\Omega \pm 25\%$)	(Ω) Max.	(mA) Max.
SBY100505T-060□-N	6	0.05	500	SBK160808T-501□-N	500	0.5	200
SBY100505T-100□-N	10	0.05	500	SBK160808T-601□-N	600	0.5	200
SBY100505T-300□-N	30	0.3	300	SBK160808T-751□-N	750	0.7	200
SBY100505T-400□-N	40	0.3	300	SBK160808T-102□-N	1000	0.7	200
SBY100505T-470□-N	47	0.4	200	SBK160808T-122□-N	1200	1	50
SBY100505T-600□-N	60	0.4	200	SBK160808T-152□-N	1500	1	50
SBY100505T-700□-N	70	0.4	200	SBK160808T-202□-N	2000	1.2	50
SBY100505T-750□-N	75	0.4	200	SBK160808T-222□-N	2200	1.2	50
SBY100505T-800□-N	80	0.4	200	SBK160808T-252□-N	2500	1.3	50
SBY100505T-121□-N	120	0.5	200	SBK160808T-272□-N	2700	1.3	50
SBY100505T-151□-N	150	0.5	200	SBY201209T-070□-N	7	0.1	600
SBY100505T-221□-N	220	0.5	200	SBY201209T-090□-N	9	0.1	600
SBY100505T-241□-N	240	0.5	200	SBY201209T-100□-N	10	0.1	600
SBY100505T-301□-N	300	0.8	200	SBY201209T-110□-N	11	0.1	600
SBY100505T-481□-N	480	0.8	200	SBY201209T-170□-N	17	0.1	600
SBY100505T-601□-N	600	1	200	SBY201209T-190□-N	19	0.1	600
SBY100505T-102□-N	1000	1.5	100	SBY201209T-220□-N	22	0.1	600
SBY100505T-152□-N	1500	2	60	SBY201209T-260□-N	26	0.1	600
SBK160808T-050□-N	5	0.05	500	SBY201209T-280□-N	28	0.1	600
SBK160808T-060□-N	6	0.05	500	SBY201209T-300□-N	30	0.1	600
SBK160808T-070□-N	7	0.05	500	SBY201209T-310□-N	31	0.1	600
SBK160808T-100□-N	10	0.05	500	SBY201209T-320□-N	32	0.1	600
SBK160808T-110□-N	11	0.05	500	SBY201209T-390□-N	39	0.1	500
SBK160808T-150□-N	15	0.08	500	SBY201209T-400□-N	40	0.1	500
SBK160808T-170□-N	17	0.08	500	SBY201209T-470□-N	47	0.1	500
SBK160808T-190□-N	19	0.08	500	SBY201209T-500□-N	50	0.1	500
SBK160808T-220□-N	22	0.1	400	SBY201209T-560□-N	56	0.15	500
SBK160808T-250□-N	25	0.1	400	SBK201209T-600□-N	60	0.15	500
SBK160808T-260□-N	26	0.1	400	SBK201209T-700□-N	70	0.15	500
SBK160808T-300□-N	30	0.1	400	SBK201209T-750□-N	75	0.15	500
SBK160808T-310□-N	31	0.1	400	SBK201209T-800□-N	80	0.15	500
SBK160808T-400□-N	40	0.1	400	SBK201209T-900□-N	90	0.15	500
SBK160808T-470□-N	47	0.1	300	SBK201209T-101□-N	100	0.25	300
SBK160808T-500□-N	50	0.1	300	SBK201209T-121□-N	120	0.25	300
SBK160808T-600□-N	60	0.1	300	SBK201209T-151□-N	150	0.25	300
SBK160808T-680□-N	68	0.15	300	SBK201209T-201□-N	200	0.3	300
SBK160808T-700□-N	70	0.15	300	SBK201209T-221□-N	220	0.3	300
SBK160808T-750□-N	75	0.15	300	SBK201209T-241□-N	240	0.3	300
SBK160808T-800□-N	80	0.15	300	SBK201209T-301□-N	300	0.3	300
SBK160808T-900□-N	90	0.2	300	SBK201209T-331□-N	330	0.3	300
SBK160808T-101□-N	100	0.2	300	SBK201209T-401□-N	400	0.3	300
SBK160808T-121□-N	120	0.25	400	SBK201209T-431□-N	430	0.4	300
SBK160808T-151□-N	150	0.3	200	SBK201209T-451□-N	450	0.4	300
SBK160808T-181□-N	180	0.3	200	SBK201209T-471□-N	470	0.4	300
SBK160808T-201□-N	200	0.3	200	SBK201209T-501□-N	500	0.4	300
SBK160808T-121□-N	220	0.3	200	SBK201209T-601□-N	600	0.4	300
SBK160808T-241□-N	240	0.4	200	SBK201209T-751□-N	750	0.5	200
SBK160808T-301□-N	300	0.4	200	SBK201209T-102□-N	1000	0.5	200
SBK160808T-331□-N	330	0.5	200	SBK201209T-122□-N	1200	0.6	200
SBK160808T-451□-N	450	0.5	200	SBK201209T-152□-N	1500	0.6	200
SBK160808T-471□-N	470	0.5	200	SBK201209T-202□-N	2000	0.8	100



LEAD-FREE & ROHS COMPLIANCE

PART NO.	IMPEDANCE	RDC	RATED CURRENT	PART NO.	IMPEDANCE	RDC	RATED CURRENT
	($\Omega \pm 25\%$)	(Ω) Max.	(mA) Max.		($\Omega \pm 25\%$)	(Ω) Max.	(mA) Max.
SBK201209T-222□-N	2200	1	100	SBK321611T-401□-N	400	0.2	400
SBK201209T-252□-N	2500	1	100	SBK321611T-471□-N	470	0.2	400
SBK201209T-272□-N	2700	1.5	100	SBK321611T-501□-N	500	0.2	400
SBY321611T-080□-N	8	0.05	600	SBK321611T-601□-N	600	0.3	400
SBY321611T-090□-N	9	0.05	600	SBK321611T-102□-N	1000	0.4	200
SBY321611T-110□-N	11	0.05	600	SBK321611T-122□-N	1200	0.4	200
SBY321611T-190□-N	19	0.05	600	SBK321611T-152□-N	1500	0.45	200
SBY321611T-260□-N	26	0.05	600	SBK321611T-202□-N	2000	0.6	200
SBY321611T-300□-N	30	0.05	600	SBY321616T-250□-N	25	0.1	500
SBY321611T-310□-N	31	0.05	600	SBY321616T-600□-N	60	0.2	500
SBY321611T-320□-N	32	0.05	600	SBK321616T-700□-N	70	0.2	500
SBY321611T-470□-N	47	0.1	500	SBY322513T-320□-N	32	0.2	500
SBY321611T-500□-N	50	0.1	500	SBY322513T-600□-N	60	0.2	500
SBY321611T-600□-N	60	0.1	500	SBY322513T-900□-N	90	0.2	500
SBK321611T-700□-N	70	0.1	500	SBY451616T-500□-N	50	0.2	600
SBK321611T-750□-N	75	0.15	500	SBY451616T-600□-N	60	0.2	600
SBK321611T-800□-N	80	0.15	500	SBY451616T-800□-N	80	0.2	600
SBK321611T-900□-N	90	0.15	500	SBY451616T-900□-N	90	0.3	500
SBK321611T-101□-N	100	0.15	500	SBY451616T-101□-N	100	0.3	500
SBK321611T-121□-N	120	0.15	500	SBK451616T-151□-N	150	0.3	500
SBK321611T-151□-N	150	0.15	500	SBK451616T-171□-N	170	0.3	500
SBK321611T-201□-N	200	0.2	400	SBY453215T-700□-N	70	0.3	500
SBK321611T-221□-N	220	0.2	400	SBY453215T-121□-N	120	0.3	500
SBK321611T-301□-N	300	0.2	400				



PB SERIES, FOR HIGH CURRENT USE

APPLICATIONS

High current DC power lines for USB interface circuitry, personal computers, electronic games, hard disk drives, and other general electronic equipment.

FEATURES

Suitable for High Current Applications
 Small Package Size-EIA STD 0402/0603/0805/1206/1806 and 1812
 Nickel Barrier Terminations Provide Excellent Solder Heat Resistance
 Current Rating up to 6 AMPS (Max) (High Current Handling Capacity)
 Low DCR
 Suitable for Flow and Reflow Soldering
 Available in 6 Sizes

ELECTRICAL CHARACTERISTICS

PART NO.	IMPEDANCE at 100MHz ($\Omega \pm 25\%$)	DC RESISTANCE (Ω) Max.	RATED CURRENT (mA) Max.
PBY100505T-100Y-S	10	0.03	1000
PBY160808T-110Y-S	11	0.02	4000
PBY160808T-250Y-S	25	0.03	3000
PBY160808T-400Y-S	40	0.035	3000
PBY160808T-600Y-S	60	0.04	3000
PBY160808T-121Y-S	120	0.08	2500
PBY160808T-151Y-S	150	0.085	2000
PBY160808T-181Y-S	180	0.09	2000
PBY160808T-201Y-S	200	0.095	2000
PBY160808T-301Y-S	300	0.10	2000
PBY160808T-501Y-S	500	0.15	1500
PBY160808T-601Y-S	600	0.20	1000
PBY160808T-102Y-S	1000	0.25	800
PBY201209T-110Y-S	11	0.01	6000
PBY201209T-170Y-S	17	0.02	5000
PBY201209T-300Y-S	30	0.015	5000
PBY201209T-500Y-S	50	0.025	3000
PBY201209T-600Y-S	60	0.03	3000
PBY201209T-800Y-S	80	0.04	3000
PBY201209T-121Y-S	120	0.04	3000
PBY201209T-201Y-S	200	0.05	2500
PBY201209T-301Y-S	300	0.08	2000
PBY201209T-601Y-S	600	0.10	2000
PBY201209T-102Y-S	1000	0.12	1500
PBY321611T-190Y-S	19	0.015	6000
PBY321611T-320Y-S	32	0.015	4000
PBY321611T-500Y-S	50	0.02	4000
PBY321611T-800Y-S	80	0.025	3000
PBY321611T-101Y-S	100	0.03	2500
PBY321611T-121Y-S	120	0.03	2500
PBY321611T-221Y-S	220	0.05	2000
PBY321611T-301Y-S	300	0.06	2000
PBY321611T-601Y-S	600	0.10	1800
PBY321611T-102Y-S	1000 *	0.15	1200
PBY321611T-122Y-S	1200 *	0.18	1000
PBY321611T-152Y-S	1500 *	0.20	800
PBY322513T-600Y-S	60	0.025	4000
PBY322513T-900Y-S	90	0.025	3000
PBY451616T-500Y-S	50	0.020	6000
PBY451616T-600Y-S	60	0.020	5000
PBY451616T-800Y-S	80	0.025	4000
PBY451616T-900Y-S	90	0.04	4000
PBY451616T-151Y-S	150	0.100	2000
PBY453215T-700Y-S	70	0.03	6000
PBY453215T-121Y-S	120	0.03	4000
PBY453215T-151Y-S	150	0.03	4000
PBY453215T-601Y-S	600	0.1	2000

Note : * at 50MHz



LEAD-FREE & ROHS COMPLIANCE

PART NO.	IMPEDANCE	RDC	RATED	PART NO.	IMPEDANCE	RDC	RATED
	($\Omega \pm 25\%$)	(Ω) Max.	CURRENT (mA) Max.		($\Omega \pm 25\%$)	(Ω) Max.	CURRENT (mA) Max.
PBY100505T-100□-N	10	0.03	1000	PBY201209T-151□-N	150	0.05	2500
PBY160808T-100□-N	10	0.02	4000	PBY201209T-181□-N	180	0.05	2500
PBY160808T-110□-N	11	0.02	4000	PBY201209T-201□-N	200	0.05	2500
PBY160808T-190□-N	19	0.03	3000	PBY201209T-221□-N	220	0.08	2000
PBY160808T-200□-N	20	0.03	3000	PBY201209T-301□-N	300	0.08	2000
PBY160808T-220□-N	22	0.03	3000	PBY201209T-331□-N	330	0.08	2000
PBY160808T-250□-N	25	0.03	3000	PBY201209T-401□-N	400	0.1	2000
PBY160808T-300□-N	30	0.03	3000	PBY201209T-471□-N	470	0.1	2000
PBY160808T-310□-N	31	0.035	3000	PBY201209T-501□-N	500	0.1	2000
PBY160808T-400□-N	40	0.035	3000	PBY201209T-601□-N	600	0.1	2000
PBY160808T-470□-N	47	0.04	3000	PBY201209T-102□-N	1000	0.12	1500
PBY160808T-500□-N	50	0.04	3000	PBY321611T-080□-N	8	0.015	6000
PBY160808T-560□-N	56	0.04	3000	PBY321611T-110□-N	11	0.015	6000
PBY160808T-600□-N	60	0.04	3000	PBY321611T-190□-N	19	0.015	6000
PBY160808T-680□-N	68	0.05	2500	PBY321611T-260□-N	26	0.015	6000
PBY160808T-700□-N	70	0.05	2500	PBY321611T-300□-N	30	0.015	4000
PBY160808T-750□-N	75	0.05	2500	PBY321611T-310□-N	31	0.015	4000
PBY160808T-800□-N	80	0.05	2500	PBY321611T-320□-N	32	0.015	4000
PBY160808T-900□-N	90	0.05	2500	PBY321611T-420□-N	42	0.015	4000
PBY160808T-101□-N	100	0.05	2500	PBY321611T-500□-N	50	0.02	4000
PBY160808T-121□-N	120	0.08	2500	PBY321611T-600□-N	60	0.02	4000
PBY160808T-151□-N	150	0.085	2000	PBY321611T-680□-N	68	0.02	4000
PBY160808T-181□-N	180	0.09	2000	PBY321611T-700□-N	70	0.02	4000
PBY160808T-201□-N	200	0.095	2000	PBY321611T-800□-N	80	0.025	3000
PBY160808T-221□-N	220	0.1	2000	PBY321611T-900□-N	90	0.03	3000
PBY160808T-301□-N	300	0.12	1500	PBY321611T-101□-N	100	0.03	2000
PBY160808T-331□-N	330	0.12	1500	PBY321611T-121□-N	120	0.03	2000
PBY160808T-401□-N	400	0.12	1500	PBY321611T-151□-N	150	0.04	2000
PBY160808T-471□-N	470	0.12	1500	PBY321611T-201□-N	200	0.05	2000
PBY160808T-501□-N	500	0.15	1200	PBY321611T-221□-N	220	0.05	2000
PBY160808T-601□-N	600	0.2	1000	PBY321611T-301□-N	300	0.06	2000
PBY160808T-102□-N	1000	0.25	800	PBY321611T-401□-N	400	0.1	2000
PBY201209T-070□-N	7	0.01	6000	PBY321611T-501□-N	500	0.1	2000
PBY201209T-110□-N	11	0.01	6000	PBY321611T-601□-N	600	0.1	2000
PBY201209T-170□-N	17	0.02	5000	PBY321611T-102□-N	1000	0.15	1200
PBY201209T-190□-N	19	0.02	4000	PBY321611T-122□-N	1200	0.18	1000
PBY201209T-220□-N	22	0.02	4000	PBY321611T-152□-N	1500	0.2	800
PBY201209T-280□-N	28	0.02	4000	PBY322513T-600□-N	60	0.025	4000
PBY201209T-300□-N	30	0.02	4000	PBY322513T-900□-N	90	0.025	3000
PBY201209T-310□-N	31	0.02	4000	PBY451616T-190□-N	19	0.02	6000
PBY201209T-390□-N	39	0.02	3000	PBY451616T-400□-N	40	0.02	6000
PBY201209T-400□-N	40	0.02	3000	PBY451616T-500□-N	50	0.02	6000
PBY201209T-420□-N	42	0.025	3000	PBY451616T-600□-N	60	0.02	5000
PBY201209T-500□-N	50	0.025	3000	PBY451616T-700□-N	70	0.025	5000
PBY201209T-600□-N	60	0.03	3000	PBY451616T-750□-N	75	0.025	5000
PBY201209T-700□-N	70	0.04	3000	PBY451616T-800□-N	80	0.025	4000
PBY201209T-750□-N	75	0.04	3000	PBY451616T-101□-N	100	0.1	2000
PBY201209T-800□-N	80	0.04	3000	PBY451616T-151□-N	150	0.1	2000
PBY201209T-900□-N	90	0.04	3000	PBY451616T-191□-N	190	0.1	2000
PBY201209T-101□-N	100	0.04	3000	PBY451616T-601□-N	600	0.1	2000
PBY201209T-121□-N	120	0.04	3000	PBY451616T-102□-N	1000	0.1	2000



LEAD-FREE & ROHS COMPLIANCE

www.DataSheet4U.com

PART NO.	IMPEDANCE	RDC	RATED CURRENT
	($\Omega \pm 25\%$)	(Ω) Max.	(mA) Max.
PBY451616T-132□-N	1300	0.1	2000
PBY453215T-700□-N	70	0.03	6000
PBY453215T-800□-N	80	0.03	4000
PBY453215T-900□-N	90	0.03	4000
PBY453215T-121□-N	120	0.03	4000
PBY453215T-125□-N	125	0.03	4000
PBY453215T-151□-N	150	0.03	4000



UPB SERIES, FOR ULTRA HIGH CURRENT USE

APPLICATIONS

Preventing of Electronics Magnet Interference in Power Line of PC, Printer, & CD ROM
High Frequency Filtering of Medium Speed Clocks and Video Signals

FEATURES

High Current Performance
Low D.C. Resistance Minute $m\Omega$ Typically
Impedance Character of Broad Frequency

ELECTRICAL CHARACTERISTICS

PART NO.	IMPEDANCE	DC RESISTANCE	RATED CURRENT
	at 100MHz ($\Omega \pm 25\%$)	(Ω) Max.	(mA) Max.
UPB160808T-110Y-S	11	0.015	4500
UPB160808T-170Y-S	17	0.015	4500
UPB160808T-250Y-S	25	0.015	4500
UPB160808T-300Y-S	30	0.015	4500
UPB201209T-110Y-S	11	0.015	5000
UPB201209T-150Y-S	15	0.015	5000
UPB201209T-190Y-S	19	0.015	5000
UPB201209T-260Y-S	26	0.015	5000
UPB201209T-300Y-S	30	0.015	5000
UPB201209T-330Y-S	33	0.015	5000
UPB201209T-400Y-S	40	0.015	5000
UPB201209T-500Y-S	50	0.015	5000
UPB201209T-600Y-S	60	0.020	4500
UPB201212T-600Y-S	60	0.02	5000
UPB201212T-700Y-S	70	0.02	5000
UPB201212T-800Y-S	80	0.02	5000
UPB201212T-101Y-S	100	0.025	5000
UPB201212T-121Y-S	120	0.025	5000
UPB321611T-110Y-S	11	0.012	6000
UPB321611T-190Y-S	19	0.012	6000
UPB321611T-260Y-S	26	0.012	6000
UPB321611T-300Y-S	30	0.012	6000
UPB321611T-400Y-S	40	0.012	6000
UPB321611T-500Y-S	50	0.012	6000
UPB321611T-600Y-S	60	0.012	6000
UPB321611T-800Y-S	80	0.012	6000
UPB321611T-101Y-S	100	0.012	6000
UPB321611T-121Y-S	120	0.012	6000
UPB321611T-151Y-S	150	0.020	4500
UPB321616T-600Y-S	60	0.012	6000
UPB323215T-700Y-S	70	0.01	9000



www.DataSheet4U.com
ELECTRICAL CHARACTERISTICS : LEAD-FREE & ROHS COMPLIANCE

PART NO.	IMPEDANCE	DC RESISTANCE	RATED CURRENT
	at 100MHz ($\Omega \pm 25\%$)	(Ω) Max.	(mA) Max.
UPB160808T-110 □ -N	11	0.015	4500
UPB160808T-170 □ -N	17	0.015	4500
UPB160808T-250 □ -N	25	0.015	4500
UPB160808T-300 □ -N	30	0.015	4500
UPB201209T-110 □ -N	11	0.012	5000
UPB201209T-150 □ -N	15	0.012	5000
UPB201209T-190 □ -N	19	0.012	5000
UPB201209T-260 □ -N	26	0.012	5000
UPB201209T-300 □ -N	30	0.012	5000
UPB201209T-330 □ -N	33	0.012	5000
UPB201209T-400 □ -N	40	0.015	5000
UPB201209T-500 □ -N	50	0.015	5000
UPB201209T-600 □ -N	60	0.02	4500
UPB201209T-700 □ -N	70	0.02	4500
UPB201209T-800 □ -N	80	0.02	4500
UPB201212T-600 □ -N	60	0.02	5000
UPB201212T-700 □ -N	70	0.02	5000
UPB201212T-800 □ -N	80	0.02	5000
UPB201212T-101 □ -N	100	0.025	5000
UPB201212T-121 □ -N	120	0.025	5000
UPB321611T-110 □ -N	11	0.012	6000
UPB321611T-190 □ -N	19	0.012	6000
UPB321611T-260 □ -N	26	0.012	6000
UPB321611T-300 □ -N	30	0.012	6000
UPB321611T-320 □ -N	32	0.012	6000
UPB321611T-400 □ -N	40	0.012	6000
UPB321611T-500 □ -N	50	0.012	6000
UPB321611T-600 □ -N	60	0.012	6000
UPB321611T-800 □ -N	80	0.012	6000
UPB321611T-101 □ -N	100	0.012	6000
UPB321611T-121 □ -N	120	0.012	6000
UPB321611T-151 □ -N	150	0.02	4500
UPB451616T-600 □ -N	60	0.012	7000
UPB453215T-700 □ -N	70	0.01	9000
UPB453215T-900 □ -N	90	0.01	9000

NOTE : □ -tolerance Y= $\pm 25\%$ / T= $\pm 30\%$

1. Operating temperature range -55°C~125°C

2. Rate current: Applied the current to coils, the temperature rise shall not be more than 30°C

"-N" FOR COMPLETELY LEAD FREE TYPE (INCLUDING FERRITE BODY & SOLDER)



NB SERIES, FOR HIGH SPEED SIGNALS USE

APPLICATIONS

High-Speed Circuits for Computer & Peripheral Equipments and Communication Devices

Cellular Phone

Suitable for Circuits with Unstable Ground

FEATURES

Exhibiting High Impedance with Sharp Increase at High-Speed Signal Frequencies with Minimal Diminishing the Desired Wave Form

Suitable for Flow and Reflow Soldering

Available in 4 Sizes

ELECTRICAL CHARACTERISTICS

PART NO.	IMPEDANCE	DC RESISTANCE	RATED CURRENT
	at 100MHz ($\Omega \pm 25\%$)	(Ω) Max.	(mA) Max.
NBQ100505T-060Y-S	6	0.10	300
NBQ100505T-100Y-S	10	0.20	200
NBQ100505T-400Y-S	40	0.40	150
NBQ100505T-800Y-S	80	0.60	100
NBQ100505T-121Y-S	120	0.80	50
NBQ160808T-060Y-S	6	0.05	500
NBQ160808T-100Y-S	10	0.07	400
NBQ160808T-400Y-S	40	0.30	300
NBQ160808T-600Y-S	60	0.30	300
NBQ160808T-800Y-S	80	0.40	300
NBQ160808T-121Y-S	120	0.40	300
NBQ160808T-241Y-S	240	0.40	200
NBQ160808T-301Y-S	300	0.50	200
NBQ160808T-481Y-S	480	0.60	150
NBQ160808T-601Y-S	600	0.60	100
NBQ160808T-102Y-S	1000	0.70	100
NBQ160808T-122Y-S	1200	0.70	100
NBQ160808T-152Y-S	1500	0.80	100
NBQ160808T-182Y-S	1800	0.95	100
NBQ160808T-222Y-S	2200	1.0	50
NBQ160808T-252Y-S	2500	1.0	50
NBQ201209T-060Y-S	6	0.07	800
NBQ201209T-110Y-S	11	0.10	700
NBQ201209T-260Y-S	26	0.15	600
NBQ201209T-320Y-S	32	0.15	600
NBQ201209T-600Y-S	60	0.15	500
NBQ201209T-750Y-S	75	0.15	500
NBQ201209T-900Y-S	90	0.15	500
NBQ201209T-121Y-S	120	0.20	400
NBQ201209T-151Y-S	150	0.20	400
NBQ201209T-171Y-S	170	0.30	400
NBQ201209T-221Y-S	220	0.30	300
NBQ201209T-301Y-S	300	0.30	300
NBQ201209T-401Y-S	400	0.35	300
NBQ201209T-501Y-S	500	0.35	200
NBQ201209T-601Y-S	600	0.35	200
NBQ201209T-102Y-S	1000	0.40	200
NBQ201209T-122Y-S	1200	0.45	200
NBQ201209T-152Y-S	1500	0.45	200
NBQ201209T-222Y-S	2200	0.50	200
NBQ201209T-272Y-S	2700	0.60	200
NBQ321611T-320Y-S	32	0.15	600
NBQ321611T-600Y-S	60	0.15	500
NBQ321611T-800Y-S	80	0.15	500
NBQ321611T-900Y-S	90	0.15	500
NBQ321611T-121Y-S	120	0.20	400
NBQ321611T-151Y-S	150	0.20	400
NBQ321611T-201Y-S	200	0.25	300
NBQ321611T-221Y-S	220	0.30	300
NBQ321611T-351Y-S	350	0.30	300
NBQ321611T-401Y-S	400	0.30	300
NBQ321611T-601Y-S	600	0.35	300
NBQ321611T-122Y-S	1200	0.40	200
NBQ321611T-152Y-S	1500	0.45	200



www.DataSheet4U.com
ELECTRICAL CHARACTERISTICS : LEAD-FREE & ROHS COMPLIANCE

PART NO.	IMPEDANCE	DC RESISTANCE	RATED CURRENT
	at 100MHz ($\Omega \pm 25\%$)	(Ω) Max.	(mA) Max.
NBQ100505T-060 □ -N	6	0.1	300
NBQ100505T-100 □ -N	10	0.2	200
NBQ100505T-220 □ -N	22	0.4	150
NBQ100505T-400 □ -N	40	0.4	150
NBQ100505T-600 □ -N	60	0.6	100
NBQ100505T-800 □ -N	80	0.6	100
NBQ100505T-121 □ -N	120	0.8	50
NBQ100505T-221 □ -N	220	1.4	50
NBQ160808T-060 □ -N	6	0.05	500
NBQ160808T-100 □ -N	10	0.07	400
NBQ160808T-300 □ -N	30	0.2	300
NBQ160808T-400 □ -N	40	0.2	300
NBQ160808T-470 □ -N	47	0.2	300
NBQ160808T-500 □ -N	50	0.25	300
NBQ160808T-600 □ -N	60	0.25	300
NBQ160808T-680 □ -N	68	0.25	300
NBQ160808T-700 □ -N	70	0.25	300
NBQ160808T-750 □ -N	75	0.25	300
NBQ160808T-800 □ -N	80	0.25	300
NBQ160808T-101 □ -N	100	0.3	300
NBQ160808T-121 □ -N	120	0.3	300
NBQ160808T-131 □ -N	130	0.3	300
NBQ160808T-141 □ -N	140	0.3	300
NBQ160808T-151 □ -N	150	0.3	200
NBQ160808T-161 □ -N	160	0.3	200
NBQ160808T-221 □ -N	220	0.35	200
NBQ160808T-241 □ -N	240	0.35	200
NBQ160808T-301 □ -N	300	0.4	200
NBQ160808T-471 □ -N	470	0.5	200
NBQ160808T-481 □ -N	480	0.5	200
NBQ160808T-601 □ -N	600	0.5	200
NBQ160808T-102 □ -N	1000	0.6	100
NBQ160808T-122 □ -N	1200	0.6	100
NBQ160808T-152 □ -N	1500	0.7	100
NBQ160808T-182 □ -N	1800	0.8	100
NBQ160808T-222 □ -N	2200	1	50
NBQ160808T-252 □ -N	2500	1.5	50
NBQ201209T-050 □ -N	5	0.07	800
NBQ201209T-060 □ -N	6	0.07	800
NBQ201209T-070 □ -N	7	0.1	700
NBQ201209T-110 □ -N	11	0.1	700
NBQ201209T-260 □ -N	26	0.15	600
NBQ201209T-300 □ -N	30	0.15	600
NBQ201209T-320 □ -N	32	0.15	600
NBQ201209T-400 □ -N	40	0.15	500
NBQ201209T-600 □ -N	60	0.15	500
NBQ201209T-750 □ -N	75	0.15	500
NBQ201209T-900 □ -N	90	0.15	500
NBQ201209T-101 □ -N	100	0.2	400
NBQ201209T-121 □ -N	120	0.2	400
NBQ201209T-151 □ -N	150	0.2	400
NBQ201209T-171 □ -N	170	0.3	400



www.DataSheet4U.com
ELECTRICAL CHARACTERISTICS : LEAD-FREE & ROHS COMPLIANCE

PART NO.	IMPEDANCE	DC RESISTANCE	RATED CURRENT
	at 100MHz ($\Omega \pm 25\%$)	(Ω) Max.	(mA) Max.
NBQ201209T-201 □-N	200	0.3	300
NBQ201209T-221 □-N	220	0.3	300
NBQ201209T-301 □-N	300	0.3	300
NBQ201209T-401 □-N	400	0.3	300
NBQ201209T-421 □-N	420	0.3	300
NBQ201209T-501 □-N	500	0.35	200
NBQ201209T-601 □-N	600	0.35	200
NBQ201209T-751 □-N	750	0.4	200
NBQ201209T-102 □-N	1000	0.4	200
NBQ201209T-122 □-N	1200	0.45	200
NBQ201209T-152 □-N	1500	0.45	200
NBQ201209T-202 □-N	2000	0.5	200
NBQ201209T-222 □-N	2200	0.5	200
NBQ201209T-252 □-N	2500	0.6	200
NBQ201209T-272 □-N	2700	0.6	200
NBQ321611T-170 □-N	17	0.15	600
NBQ321611T-190 □-N	19	0.15	600
NBQ321611T-320 □-N	32	0.15	600
NBQ321611T-600 □-N	60	0.15	500
NBQ321611T-800 □-N	80	0.15	500
NBQ321611T-900 □-N	90	0.15	500
NBQ321611T-121 □-N	120	0.2	400
NBQ321611T-151 □-N	150	0.2	400
NBQ321611T-201 □-N	200	0.25	300
NBQ321611T-221 □-N	220	0.3	300
NBQ321611T-351 □-N	350	0.3	300
NBQ321611T-401 □-N	400	0.3	300
NBQ321611T-601 □-N	600	0.35	300
NBQ321611T-122 □-N	1200	0.4	200
NBQ321611T-152 □-N	1500	0.45	200

NOTE : □ -tolerance Y=±25% / T=±30%

1. Operating temperature range -55°C~125°C

2. Rate current: Applied the current to coils, the temperature rise shall not be more than 30°C

"-N" FOR COMPLETELY LEAD FREE TYPE (INCLUDING FERRITE BODY & SOLDER)



GB SERIES, FOR MID CURRENT USE

APPLICATIONS

* Computers * Modems * CD-ROMs * Hard Drives
* Televisions * Wireless Device

FEATURES

This series exhibits a low DC resistance across a wide range of impedances. Low DC resistance characteristics make the chip beads suitable for use on signal lines handling larger currents.

ELECTRICAL CHARACTERISTICS

PART NO.	IMPEDANCE at 100MHz ($\Omega \pm 25\%$)	DC RESISTANCE (Ω) Max.	RATED CURRENT (mA) Max.	PART NO.	IMPEDANCE at 100MHz ($\Omega \pm 25\%$)	DC RESISTANCE (Ω) Max.	RATED CURRENT (mA) Max.
GBK160808T-110Y-S	11	0.03	1000	GBY321611T-190Y-S	19	0.03	1000
GBK160808T-190Y-S	19	0.05	1000	GBY321611T-260Y-S	26	0.03	1000
GBK160808T-300Y-S	30	0.06	800	GBY321611T-320Y-S	32	0.03	1000
GBK160808T-400Y-S	40	0.06	800	GBY321611T-500Y-S	50	0.06	800
GBK160808T-600Y-S	60	0.06	600	GBY321611T-600Y-S	60	0.06	800
GBK160808T-800Y-S	80	0.10	600	GBK321611T-700Y-S	70	0.06	800
GBK160808T-121Y-S	120	0.15	600	GBK321611T-900Y-S	90	0.10	800
GBK160808T-221Y-S	220	0.18	400	GBK321611T-121Y-S	120	0.10	800
GBK160808T-301Y-S	300	0.25	400	GBK321611T-151Y-S	150	0.10	800
GBK160808T-451Y-S	450	0.30	400	GBK321611T-201Y-S	200	0.15	600
GBK160808T-601Y-S	600	0.30	400	GBK321611T-401Y-S	400	0.15	600
GBK160808T-751Y-S	750	0.45	300	GBK321611T-501Y-S	500	0.15	600
GBK160808T-102Y-S	1000	0.45	300	GBK321611T-601Y-S	600	0.20	500
GBY201209T-070Y-S	7	0.06	1000	GBK321611T-102Y-S	1000 *	0.25	400
GBY201209T-090Y-S	9	0.06	1000	GBK321611T-122Y-S	1200 *	0.25	400
GBY201209T-110Y-S	11	0.06	1000	GBK321611T-202Y-S	2000 **	0.35	400
GBY201209T-170Y-S	17	0.06	1000	GBY321616T-250Y-S	25	0.10	1000
GBY201209T-320Y-S	32	0.06	1000	GBY321616T-600Y-S	60	0.10	1000
GBK201209T-600Y-S	60	0.10	800	GBK321616T-700Y-S	70	0.10	1000
GBK201209T-700Y-S	70	0.10	800	GBY322513T-320Y-S	32	0.10	1000
GBK201209T-800Y-S	80	0.10	800	GBY322513T-600Y-S	60	0.10	1000
GBK201209T-121Y-S	120	0.15	600	GBY322513T-900Y-S	90	0.10	1000
GBK201209T-151Y-S	150	0.15	600	GBY451616T-500Y-S	50	0.10	1000
GBK201209T-221Y-S	220	0.18	600	GBY451616T-600Y-S	60	0.10	1000
GBK201209T-301Y-S	300	0.18	600	GBY451616T-800Y-S	80	0.10	1000
GBK201209T-401Y-S	400	0.18	600	GBY451616T-101Y-S	100	0.18	800
GBK201209T-501Y-S	500	0.25	500	GBK451616T-151Y-S	150	0.18	800
GBK201209T-601Y-S	600	0.25	500	GBK451616T-171Y-S	170	0.18	800
GBK201209T-751Y-S	750	0.30	400	GBY453215T-700Y-S	70	0.18	800
GBK201209T-102Y-S	1000	0.30	400	GBY453215T-121Y-S	120	0.18	800
GBK201209T-152Y-S	1500	0.40	400				
GBK201209T-202Y-S	2000	0.55	400				

Note : * at 50MHz ** at 30MHz



www.DataSheet4U.com
ELECTRICAL CHARACTERISTICS : LEAD-FREE & ROHS COMPLIANCE

PART NO.	IMPEDANCE at 100MHz ($\Omega \pm 25\%$)	DC RESISTANCE (Ω) Max.	RATED CURRENT (mA) Max.
GBK160808T-110 □ -N	11	0.03	1000
GBK160808T-190 □ -N	19	0.05	1000
GBK160808T-300 □ -N	30	0.06	800
GBK160808T-320 □ -N	32	0.06	800
GBK160808T-400 □ -N	40	0.06	800
GBK160808T-500 □ -N	50	0.06	600
GBK160808T-600 □ -N	60	0.06	600
GBK160808T-800 □ -N	80	0.1	600
GBK160808T-101 □ -N	100	0.15	600
GBK160808T-121 □ -N	120	0.15	600
GBK160808T-181 □ -N	180	0.18	400
GBK160808T-221 □ -N	220	0.18	400
GBK160808T-301 □ -N	300	0.25	400
GBK160808T-451 □ -N	450	0.3	400
GBK160808T-471 □ -N	470	0.3	400
GBK160808T-601 □ -N	600	0.3	400
GBK160808T-751 □ -N	750	0.45	300
GBK160808T-102 □ -N	1000	0.45	300
GBK160808T-152 □ -N	1500	0.7	150
GBY201209T-070 □ -N	7	0.06	1000
GBY201209T-090 □ -N	9	0.06	1000
GBY201209T-110 □ -N	11	0.06	1000
GBY201209T-170 □ -N	17	0.06	1000
GBY201209T-300 □ -N	30	0.06	1000
GBY201209T-320 □ -N	32	0.06	1000
GBY201209T-330 □ -N	33	0.1	800
GBY201209T-400 □ -N	40	0.1	800
GBK201209T-600 □ -N	60	0.1	800
GBK201209T-700 □ -N	70	0.1	800
GBK201209T-800 □ -N	80	0.1	800
GBK201209T-101 □ -N	100	0.15	600
GBK201209T-121 □ -N	120	0.15	600
GBK201209T-151 □ -N	150	0.15	600
GBK201209T-221 □ -N	220	0.18	600
GBK201209T-301 □ -N	300	0.18	600



ELECTRICAL CHARACTERISTICS : LEAD-FREE & ROHS COMPLIANCE

PART NO.	IMPEDANCE at 100MHz ($\Omega \pm 25\%$)	DC RESISTANCE (Ω) Max.	RATED CURRENT (mA) Max.
GBK201209T-401 □ -N	400	0.18	600
GBK201209T-501 □ -N	500	0.25	500
GBK201209T-601 □ -N	600	0.25	500
GBK201209T-751 □ -N	750	0.3	400
GBK201209T-102 □ -N	1000	0.3	400
GBK201209T-152 □ -N	1500	0.4	400
GBK201209T-202 □ -N	2000	0.55	400
GBY321611T-190 □ -N	19	0.03	1000
GBY321611T-260 □ -N	26	0.03	1000
GBY321611T-320 □ -N	32	0.03	1000
GBY321611T-500 □ -N	50	0.06	800
GBY321611T-600 □ -N	60	0.06	800
GBK321611T-700 □ -N	70	0.06	800
GBK321611T-900 □ -N	90	0.1	800
GBK321611T-121 □ -N	120	0.1	800
GBK321611T-151 □ -N	150	0.1	800
GBK321611T-201 □ -N	200	0.15	600
GBK321611T-301 □ -N	300	0.15	600
GBK321611T-401 □ -N	400	0.15	600
GBK321611T-501 □ -N	500	0.15	600
GBK321611T-601 □ -N	600	0.2	500
GBK321611T-102 □ -N	1000	0.25	400
GBK321611T-122 □ -N	1200	0.25	400
GBK321611T-202 □ -N	2000	0.35	400
GBY321611T-250 □ -N	25	0.1	1000
GBY321611T-600 □ -N	60	0.1	1000
GBK321611T-700 □ -N	70	0.1	1000
GBY322513T-320 □ -N	32	0.1	1000
GBY322513T-600 □ -N	60	0.1	1000
GBY322513T-900 □ -N	90	0.1	1000
GBY451616T-500 □ -N	50	0.1	1000
GBY451616T-600 □ -N	60	0.1	1000
GBY451616T-800 □ -N	80	0.1	1000
GBY451616T-101 □ -N	100	0.18	800



ELECTRICAL CHARACTERISTICS : LEAD-FREE & ROHS COMPLIANCE

PART NO.	IMPEDANCE at 100MHz ($\Omega \pm 25\%$)	DC RESISTANCE (Ω) Max.	RATED CURRENT (mA) Max.
GBK451616T-151 □ -N	150	0.18	800
GBK451616T-171 □ -N	170	0.18	800
GBY453215T-700 □ -N	70	0.18	800
GBY453215T-121 □ -N	120	0.18	800



TAPE DIMENSIONS

Dimensions : mm

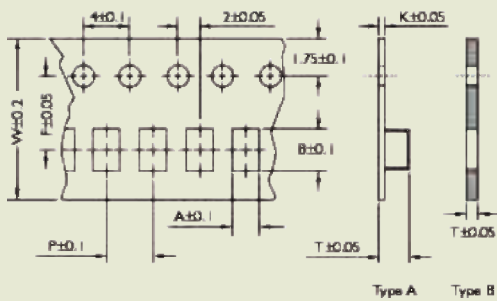

TYPE		A	B	T	W	P	F	K	TAPE TYPE
SB/PB/NB	100505	0.65	1.15	0.60	8.0	2.0	3.5	-	B
SB/PB/UP/NB/GB	160808	1.10	1.85	0.95	8.0	4.0	3.5	-	B
SB/PB/UP/NB/GB	201209	1.42	2.25	0.22	8.0	4.0	3.5	1.04	A
SB/PB/UP/NB/GB	321611	1.88	3.50	0.22	8.0	4.0	3.5	1.27	A
SB/GB	321616	1.88	3.53	0.22	8.0	4.0	3.5	1.80	A
SB/GB	322513	2.77	3.42	0.22	8.0	4.0	3.5	1.55	A
SB/PB/GB	451616	1.93	4.95	0.24	12.0	4.0	5.5	1.93	A
SB/PB/GB	453215	3.66	4.95	0.24	12.0	8.0	5.5	1.85	A

TAPE MATERIAL

Carrier Tape : Polystyrene (for 201209, 201211, 321611, etc.)
Paper (for 160808, 100505)

Cover Type : Polyethyene

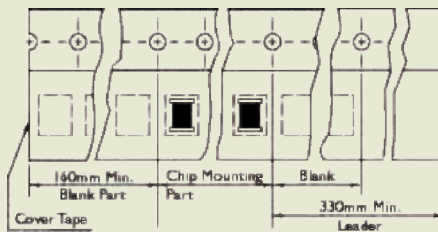

PACKAGING QUANTITY

TYPE		BULK	QUANTITY/REEL
SB/PB/NB	100505	√	10000
SB/PB/UP/NB/GB	160808	√	4000
SB/PB/UP/NB/GB	201209	√	4000
SB/PB/UP/NB/GB	321611	√	3000
SB/GB	321616	√	2000
SB/GB	322513	√	2500
SB/PB/GB	451616	√	2000
SB/PB/GB	453215	√	1000

REEL DIMENSIONS

Dimensions : mm

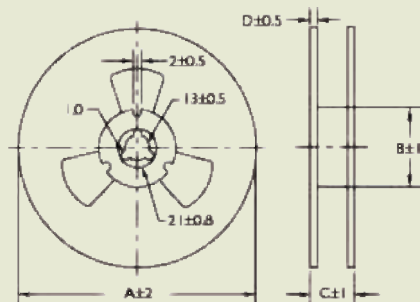

TYPE		A	B	C	D
SB/PB/NB	100505	178	60	10	2
SB/PB/UP/NB/GB	160808	178	60	10	2
SB/PB/UP/NB/GB	201209	178	60	10	2
SB/PB/UP/NB/GB	321611	178	60	10	2
SB/GB	321616	178	60	10	2
SB/GB	322513	178	60	10	2
SB/PB/GB	451616	178	60	14	2
SB/PB/GB	453215	178	60	14	2

RECOMMENDED PATTERN

Dimensions : mm

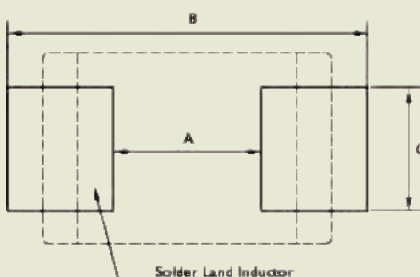

TYPE		A	B	C
SB/PB/NB	100505	0.4	1.2 ~ 1.4	0.4
SB/PB/UP/NB/GB	160808	0.8	2.4 ~ 3.4	0.6
SB/PB/UP/NB/GB	201209	1.2	3.0 ~ 4.0	1.0
SB/PB/UP/NB/GB	321611	2.0	4.2 ~ 5.2	1.2
SB/GB	321616	2.0	4.2 ~ 5.2	1.2
SB/GB	322513	2.0	5.5 ~ 6.5	1.8
SB/PB/GB	451616	3.0	5.5 ~ 6.5	1.2
SB/PB/GB	453215	3.0	5.5 ~ 6.5	1.2

* Don't apply narrower pattern than listed above to PB/UP and upb
Narrow pattern might cause excessive heat or open circuit.



TYPICAL ELECTRICAL CHARACTERISTICS

Test Instruments : HP4291A Impedance / Material Analyzer

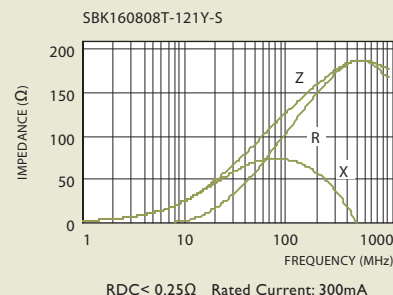
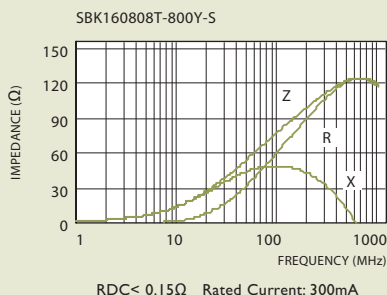
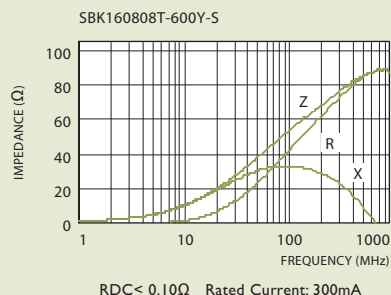
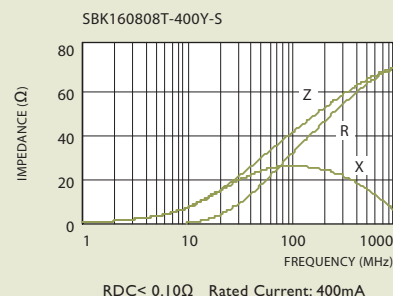
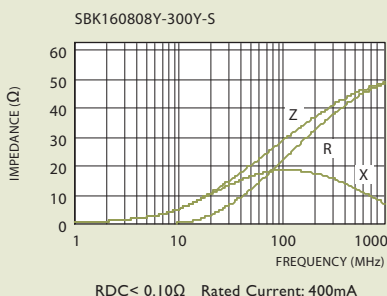
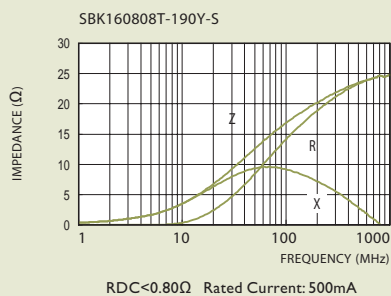
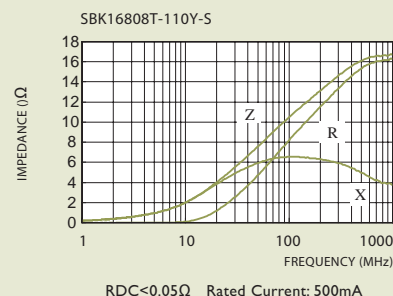
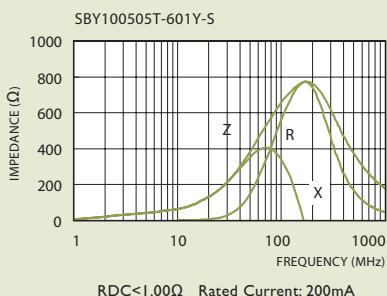
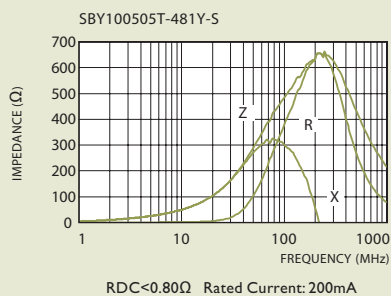
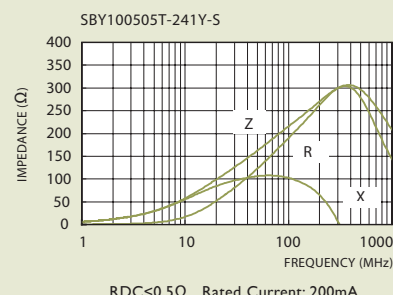
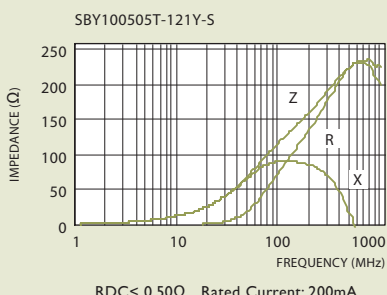
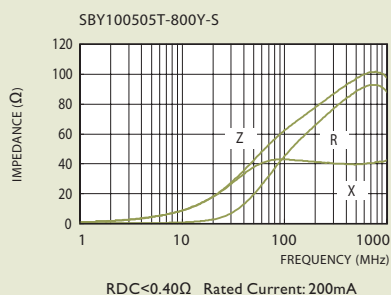
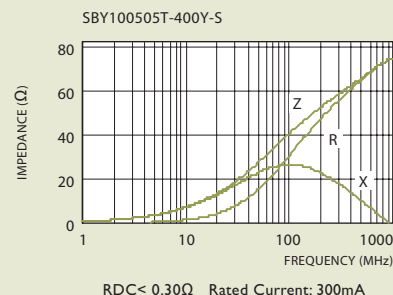
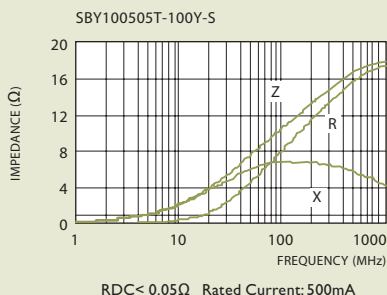
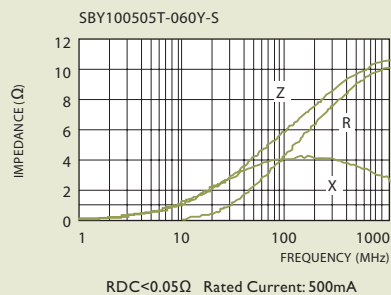



TYPICAL ELECTRICAL CHARACTERISTICS

Test Instruments : HP4291A Impedance / Material Analyzer

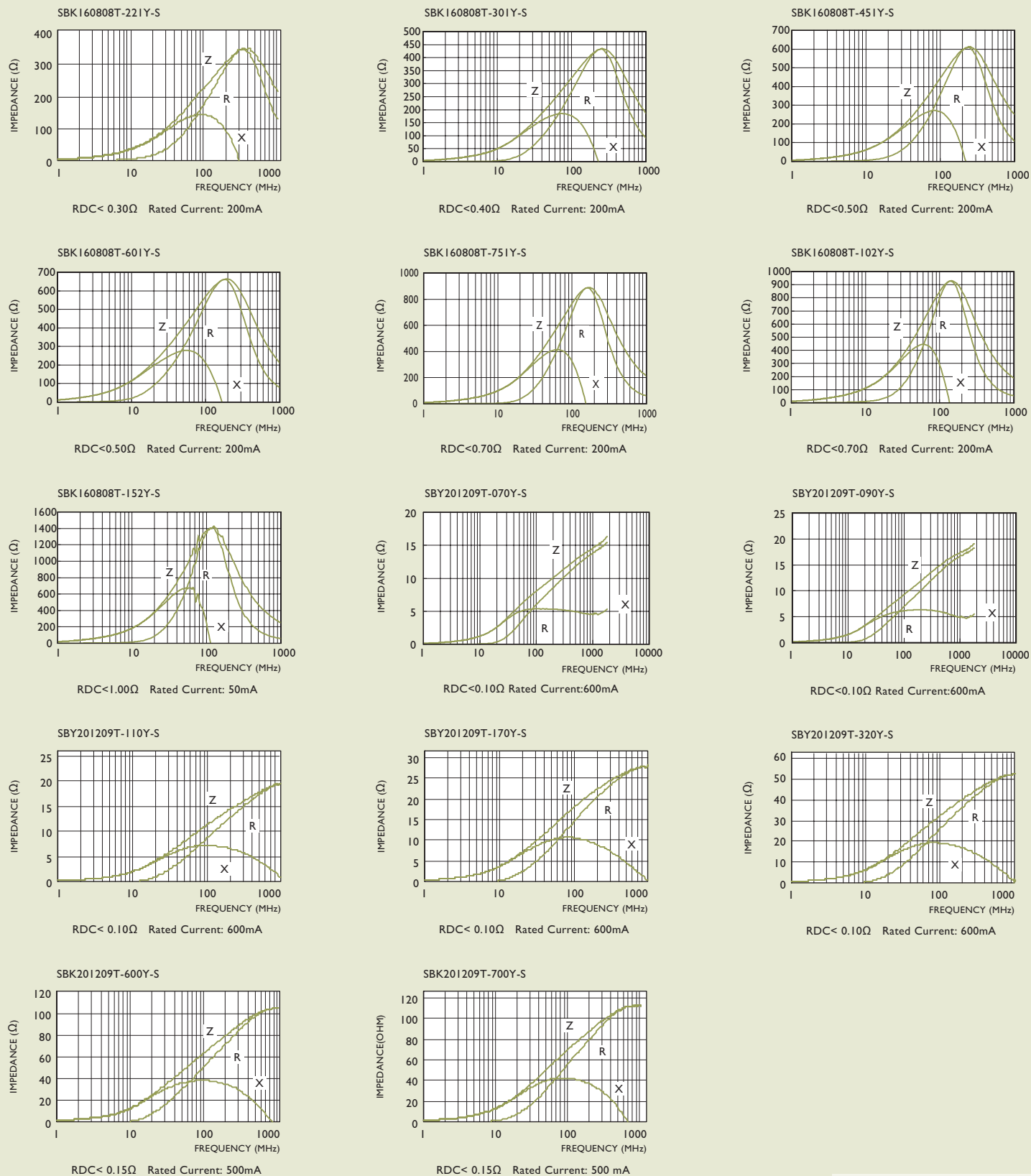



TYPICAL ELECTRICAL CHARACTERISTICS

Test Instruments : HP4291A Impedance / Material Analyzer

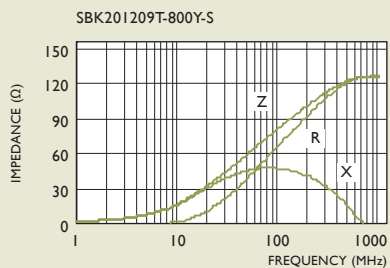

RDC < 0.15Ω Rated Current: 500mA

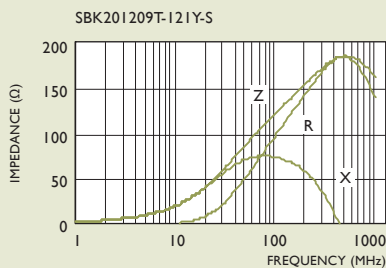

RDC < 0.25Ω Rated Current: 300mA

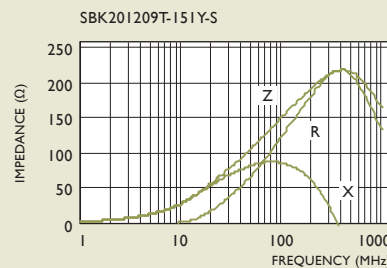

RDC < 0.25Ω Rated Current: 300mA

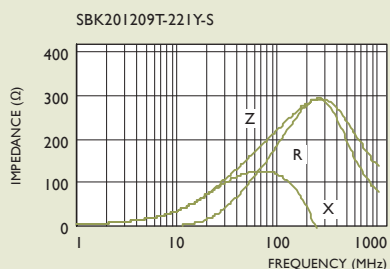

RDC < 0.30 Ω Rated Current: 300mA

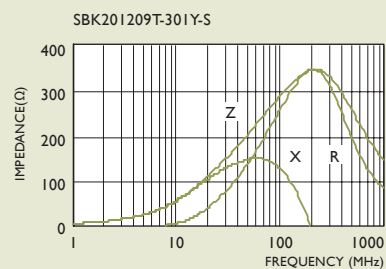

RDC < 0.30 Ω Rated Current: 300mA

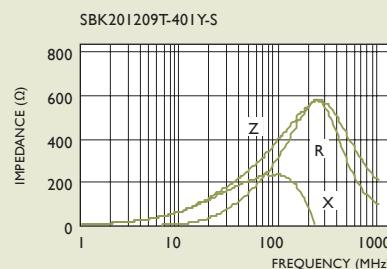

RDC < 0.30 Ω Rated Current: 300mA

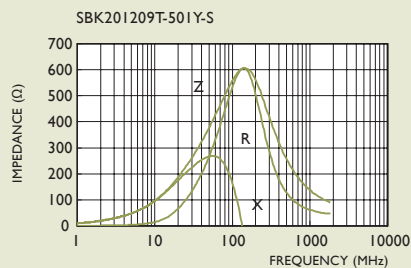

RDC < 0.40 Ω Rated Current: 300mA

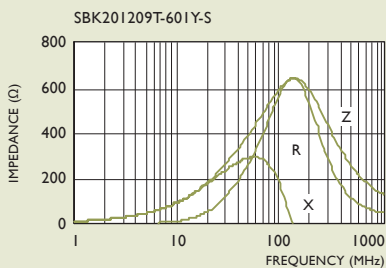

RDC < 0.40 Ω Rated Current: 300mA

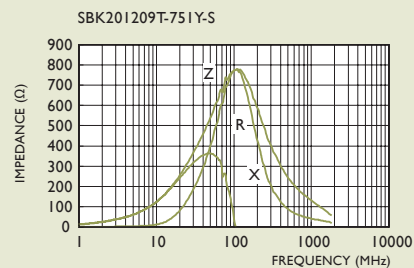

RDC < 0.50 Ω Rated Current: 200mA

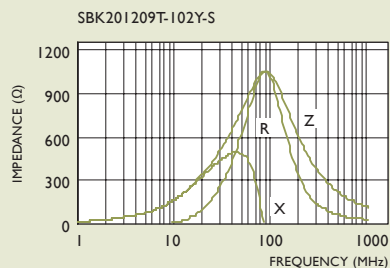

RDC < 0.50Ω Rated Current: 200mA

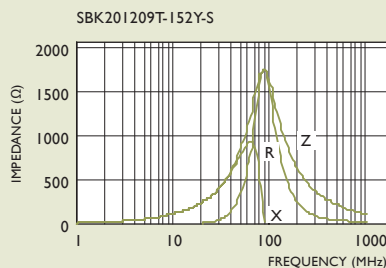

RDC < 0.60Ω Rated Current: 200mA

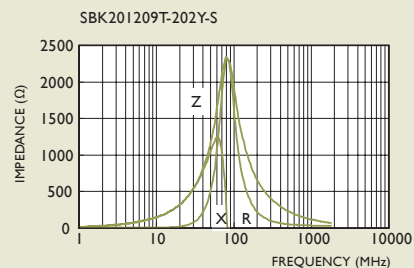

RDC < 0.80 Ω Rated Current: 100mA

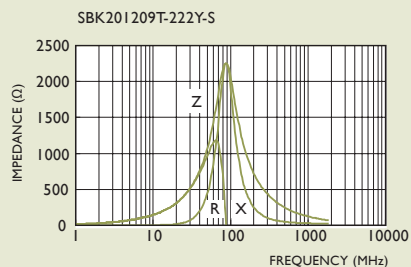

RDC < 1.00 Ω Rated Current: 100mA

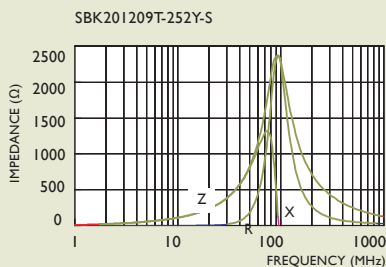

RDC < 1.00Ω Rated Current: 600mA

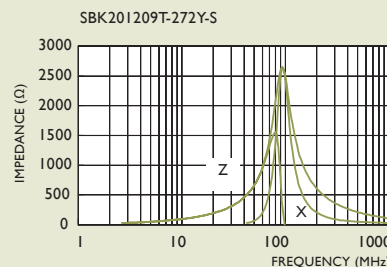

RDC < 1.50 Ω Rated Current: 600mA



TYPICAL ELECTRICAL CHARACTERISTICS

Test Instruments : HP4291A Impedance / Material Analyzer

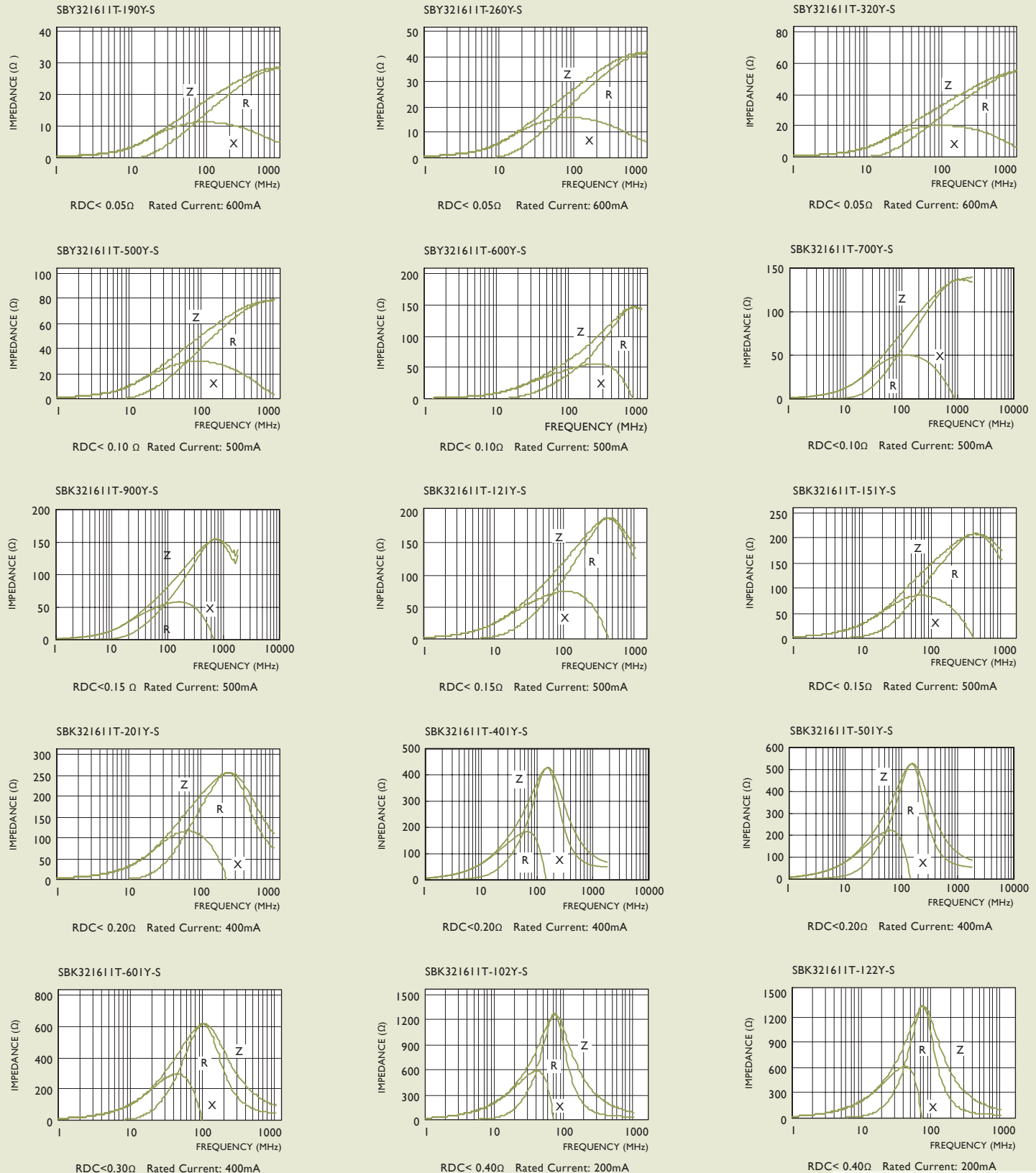



TYPICAL ELECTRICAL CHARACTERISTICS

Test Instruments : HP4291A Impedance / Material Analyzer

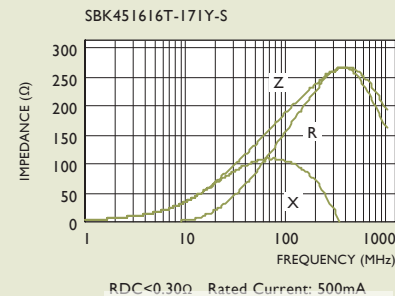
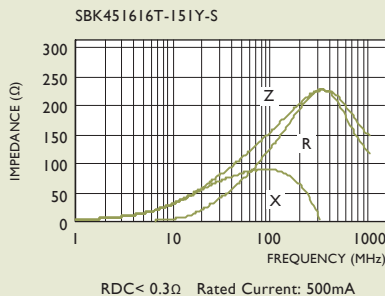
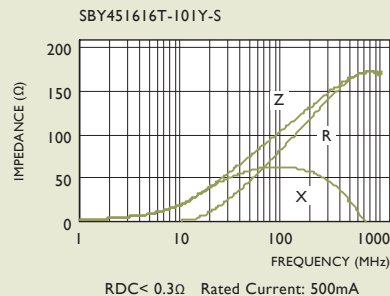
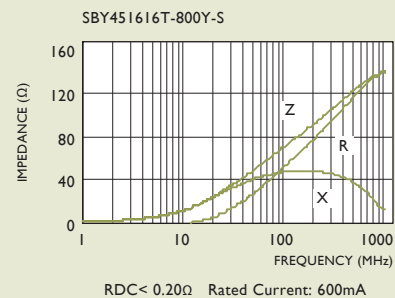
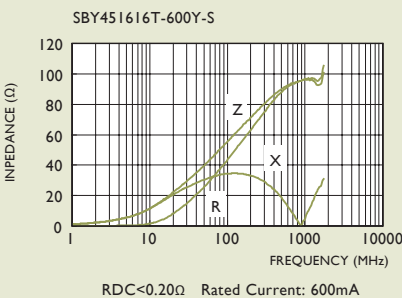
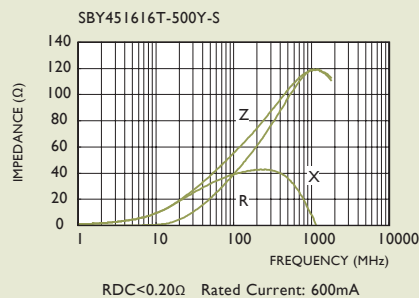
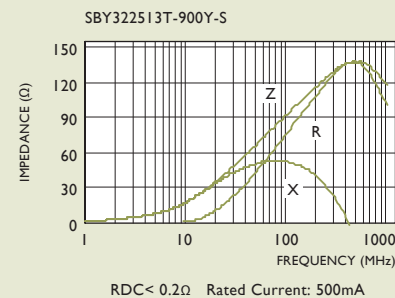
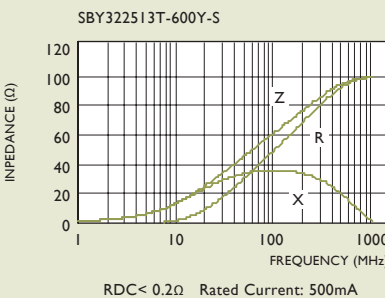
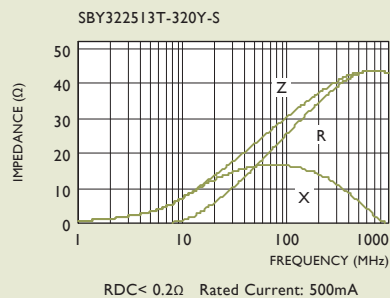
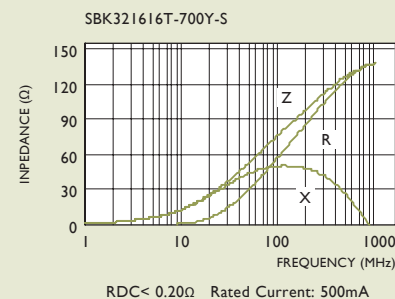
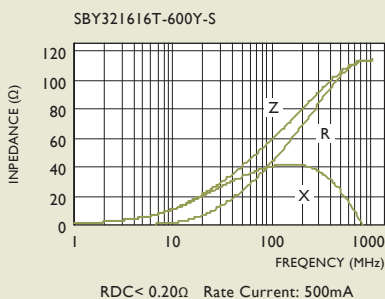
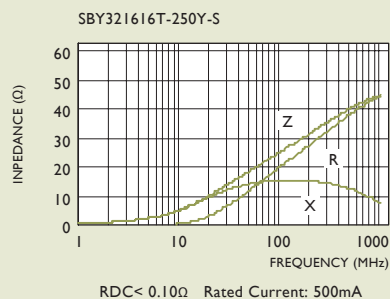
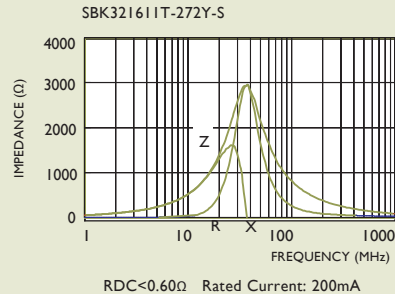
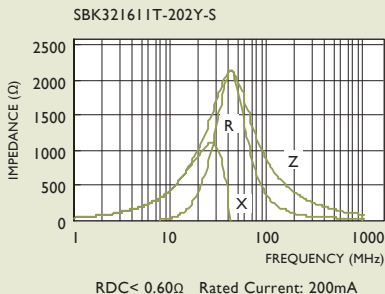
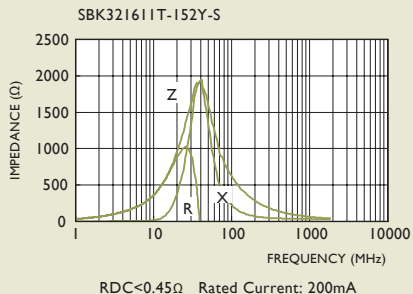



TYPICAL ELECTRICAL CHARACTERISTICS

Test Instruments : HP4291A Impedance / Material Analyzer

SBY453215T-700Y-S

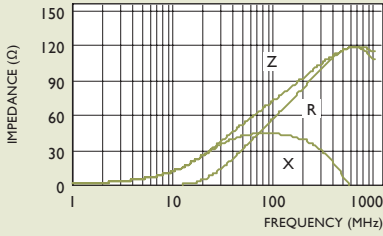

RDC < 0.3Ω Rated Current: 500mA

SBY453215T-121Y-S

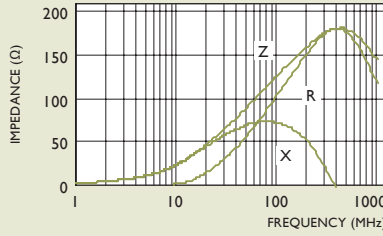

RDC < 0.3Ω Rated Current: 500mA

PBY100505T-100Y-S

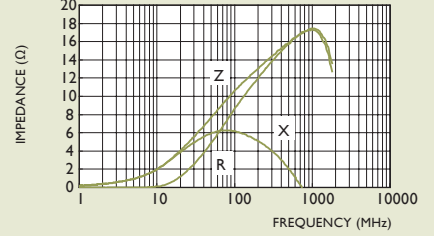

RDC < 0.03Ω Rated Current: 1000mA

PBY160808T-110Y-S

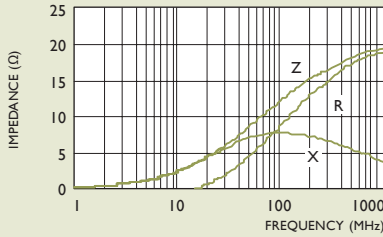

RDC < 0.020Ω Rated Current: 4000mA

PBY160808T-250Y-S

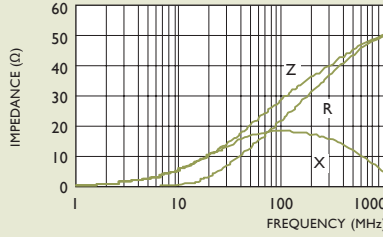

RDC < 0.03Ω Rated Current: 3000mA

PBY160808T-400Y-S

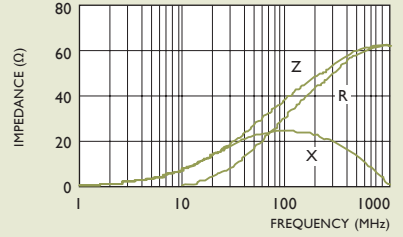

RDC < 0.035Ω Rated Current: 3000mA

PBY160808T-600Y-S

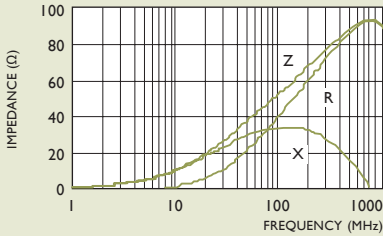

RDC < 0.04Ω Rated Current: 3000mA

PBY160808T-121Y-S

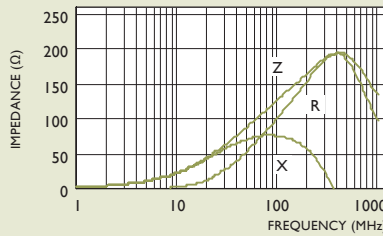

RDC < 0.08Ω Rated Current: 2500mA

PBY160808T-301Y-S

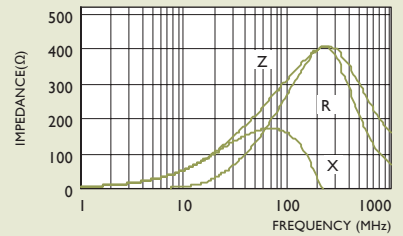

RDC < 0.10Ω Rated Current: 2000mA

PBY160808T-501Y-S

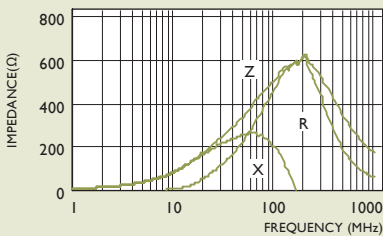

RDC < 0.15Ω Rated Current: 1500mA

PBY160808T-601Y-S

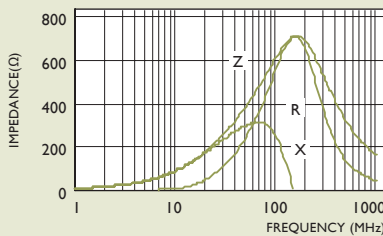

RDC < 0.20Ω Rated Current: 1000mA

PBY160808T-102Y-S

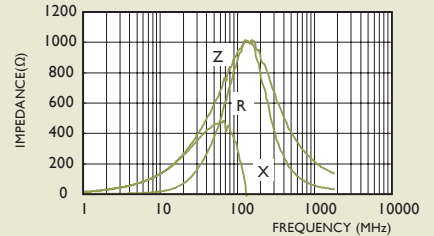

RDC < 0.25Ω Rated Current: 800mA

PBY201209T-110Y-S

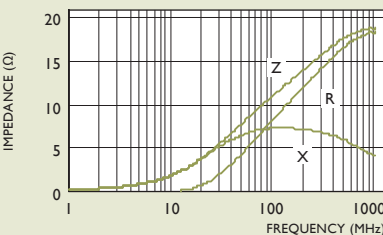

RDC < 0.01Ω Rated Current: 6000mA

PBY201209T-170Y-S

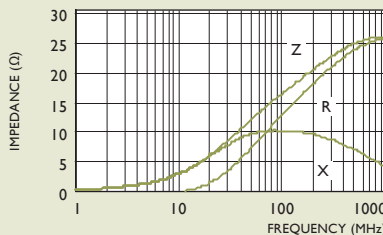

RDC < 0.02Ω Rated Current: 5000mA

PBY201209T-300Y-S

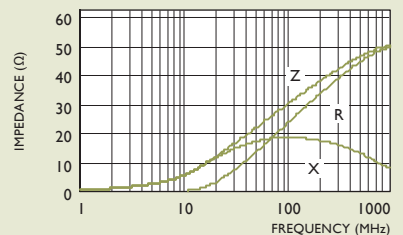

RDC < 0.15Ω Rated Current: 4000mA



TYPICAL ELECTRICAL CHARACTERISTICS

Test Instruments : HP4291A Impedance / Material Analyzer

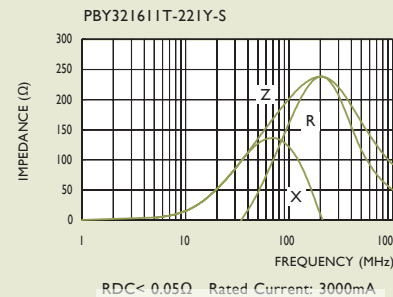
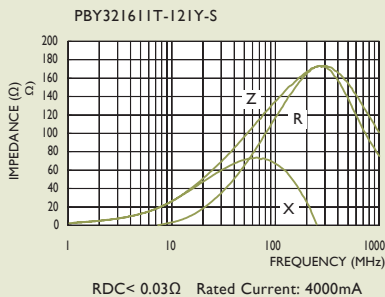
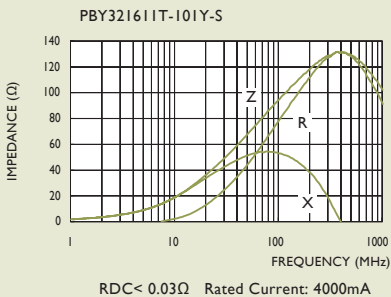
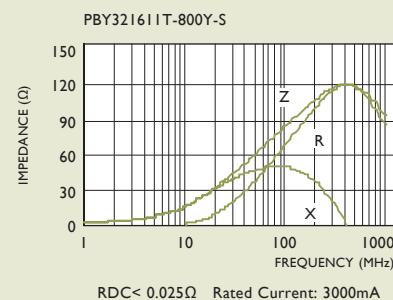
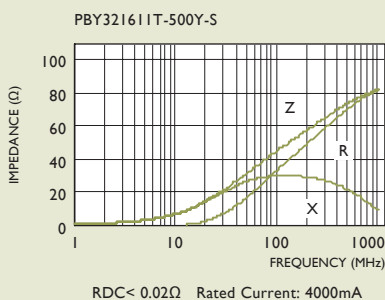
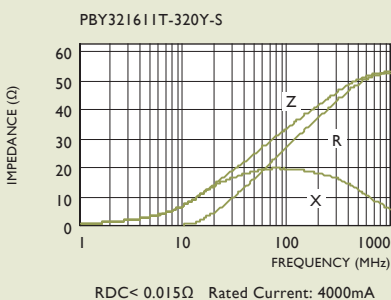
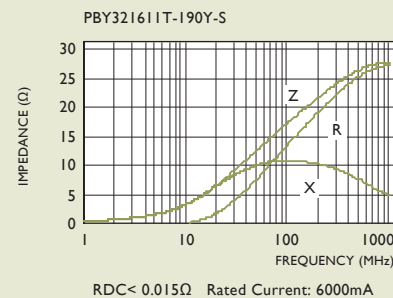
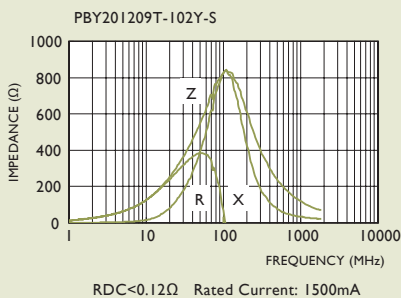
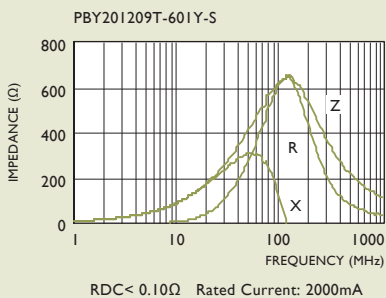
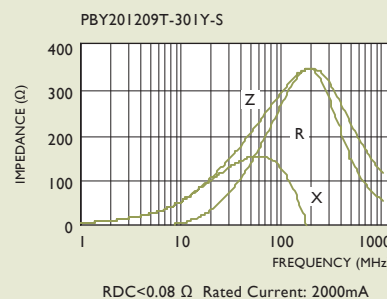
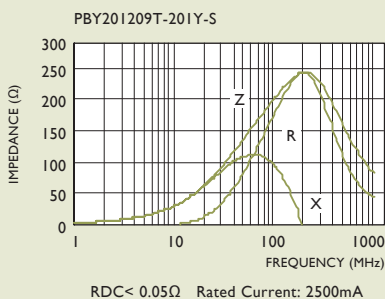
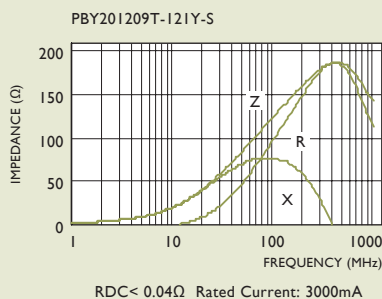
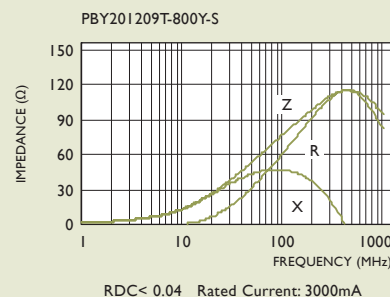
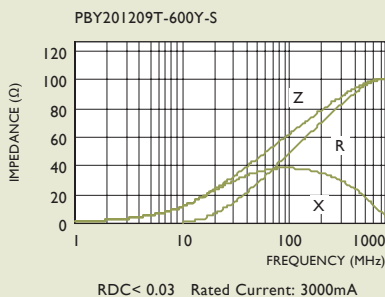
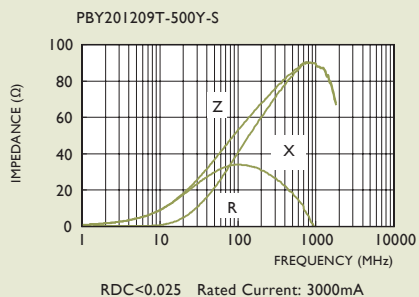



TYPICAL ELECTRICAL CHARACTERISTICS

Test Instruments : HP4291A Impedance / Material Analyzer

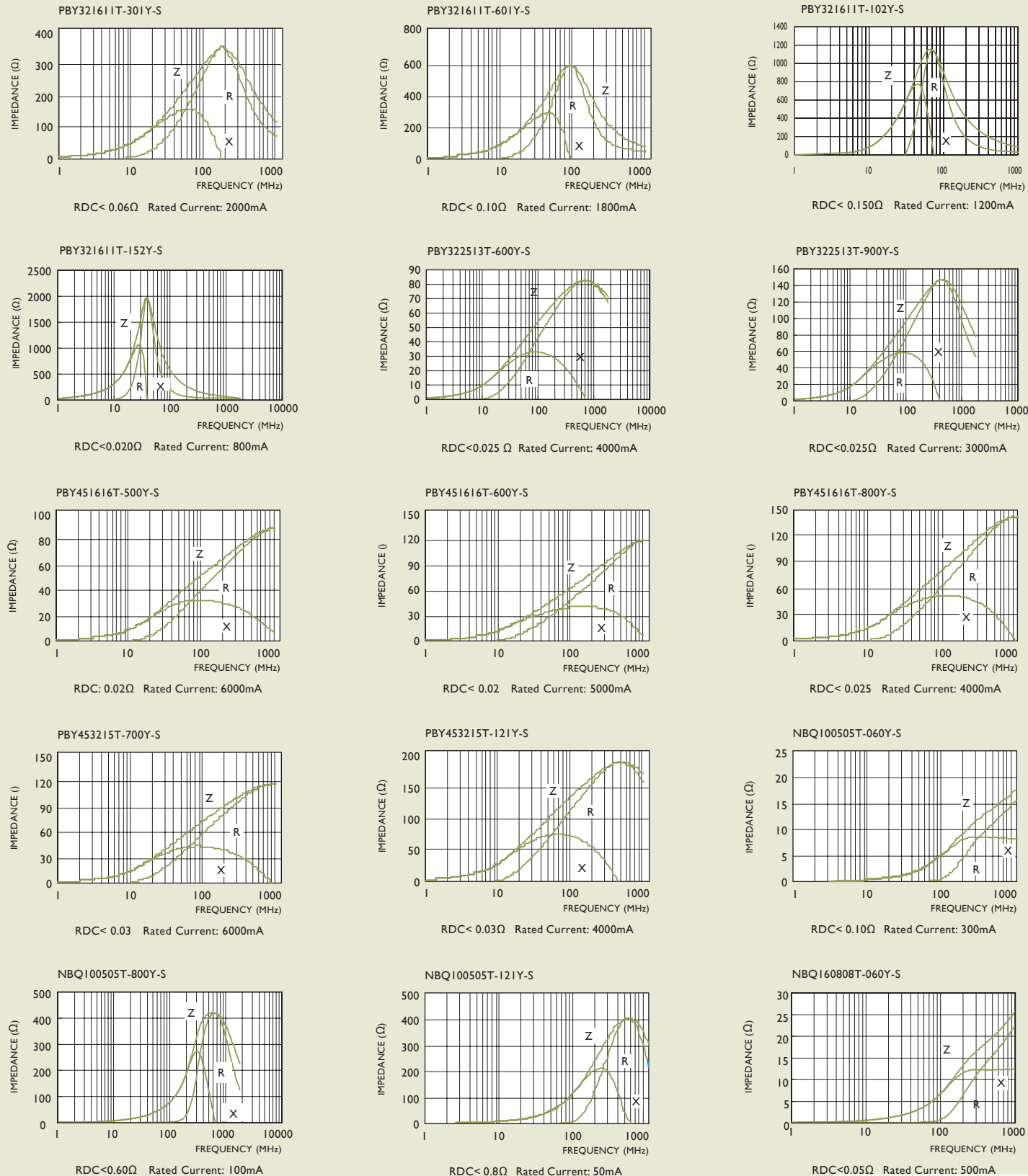



TYPICAL ELECTRICAL CHARACTERISTICS

Test Instruments : HP4291A Impedance / Material Analyzer

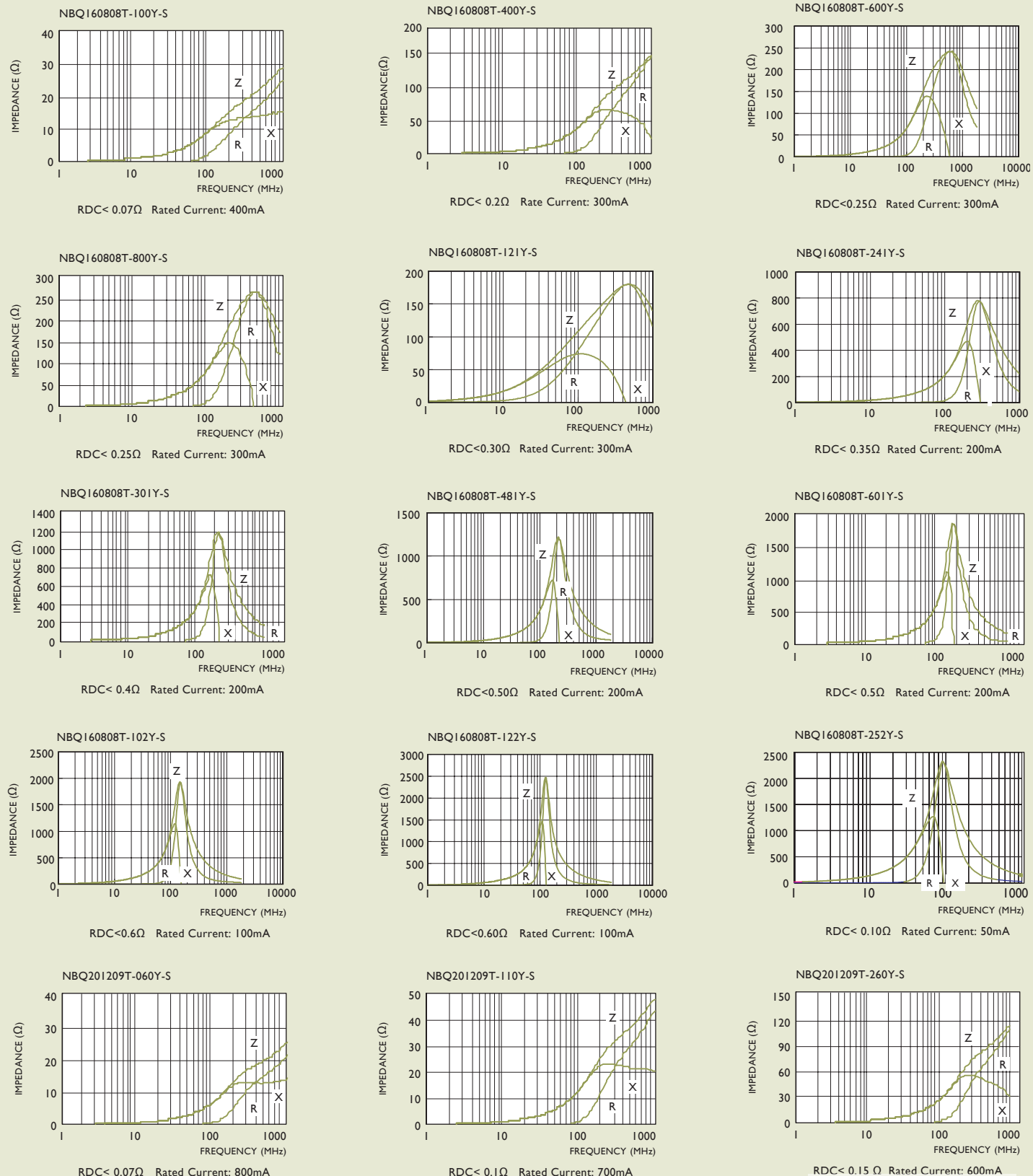



TYPICAL ELECTRICAL CHARACTERISTICS

Test Instruments : HP4291A Impedance / Material Analyzer

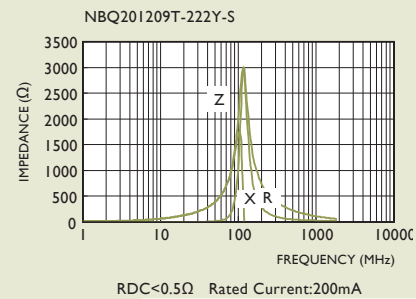
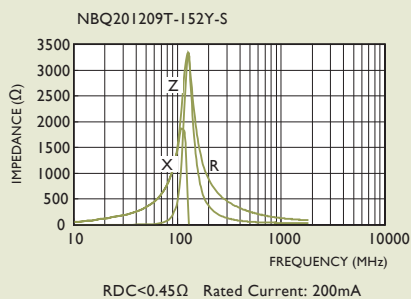
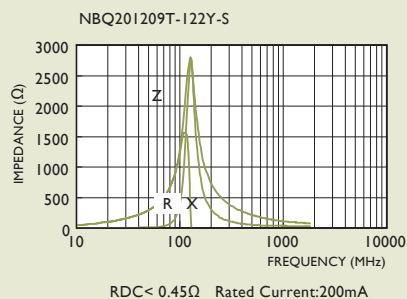
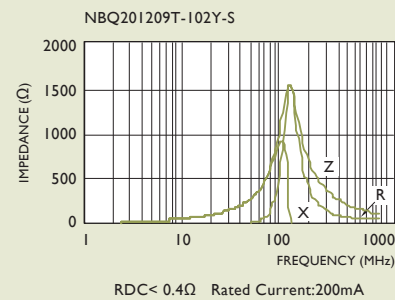
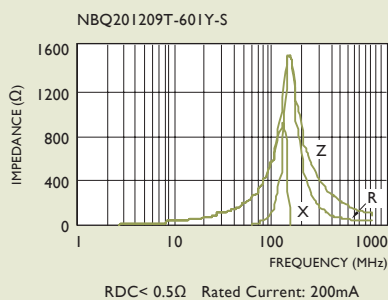
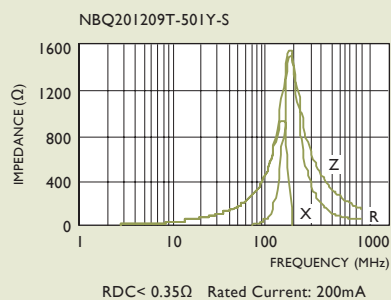
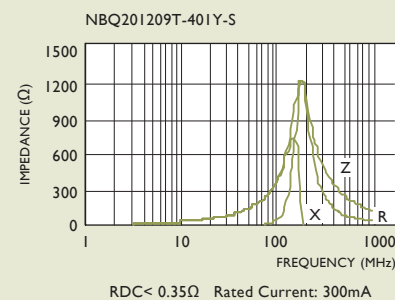
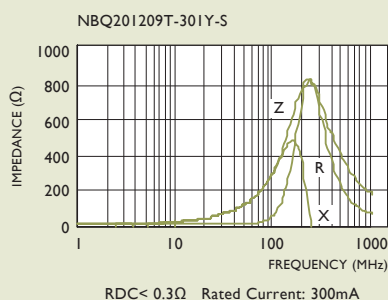
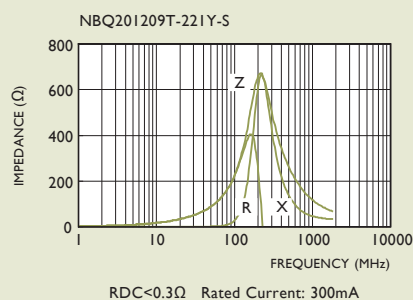
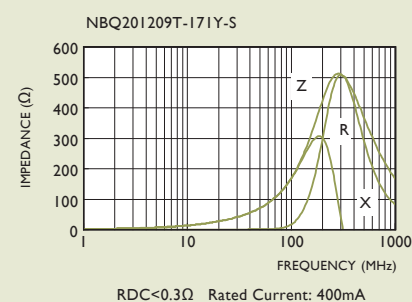
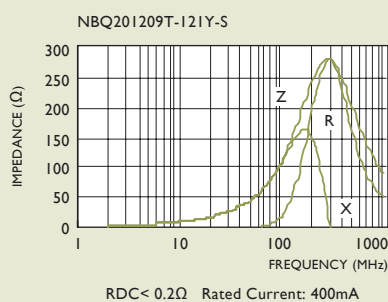
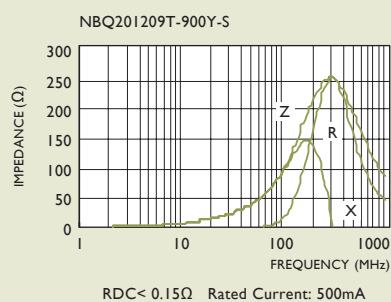
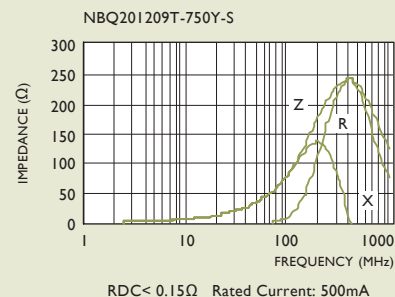
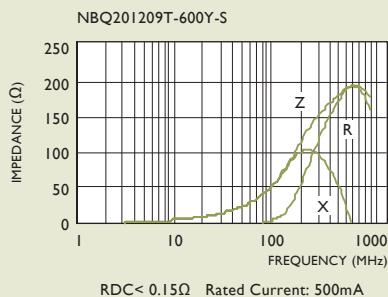
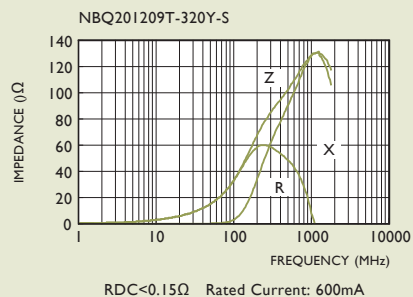



TYPICAL ELECTRICAL CHARACTERISTICS

Test Instruments : HP4291A Impedance / Material Analyzer

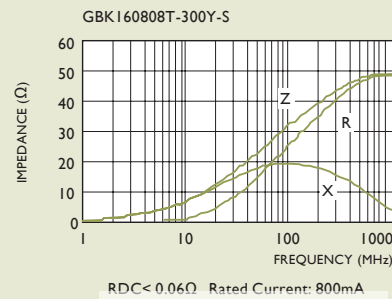
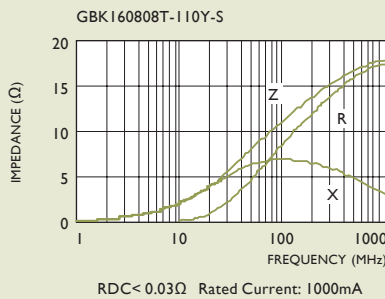
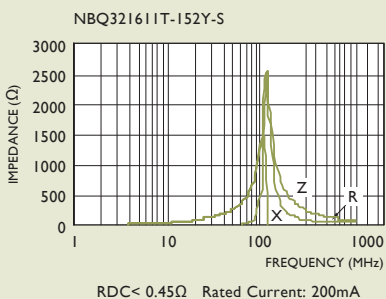
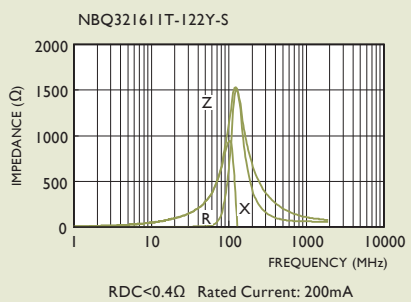
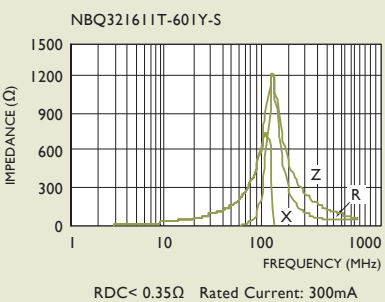
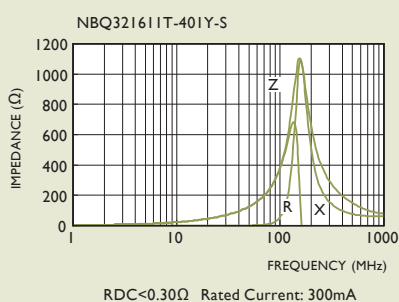
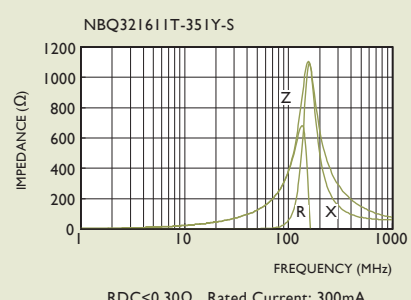
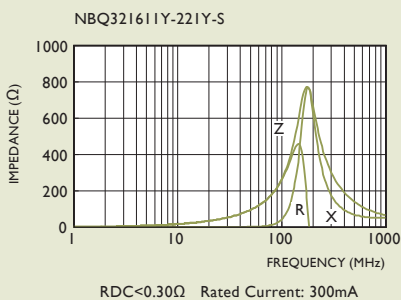
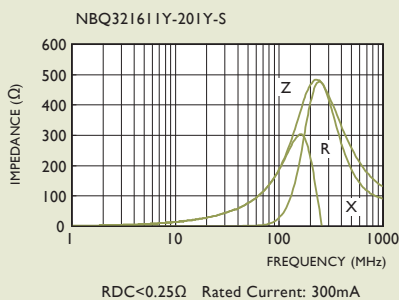
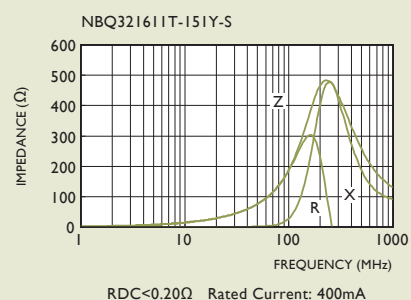
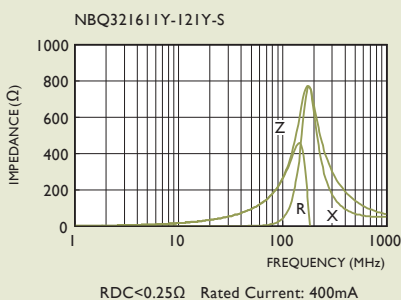
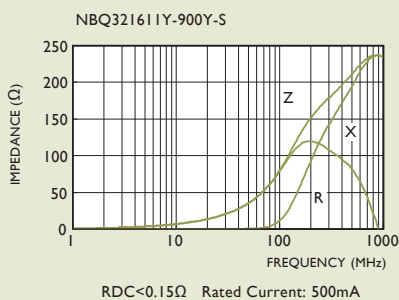
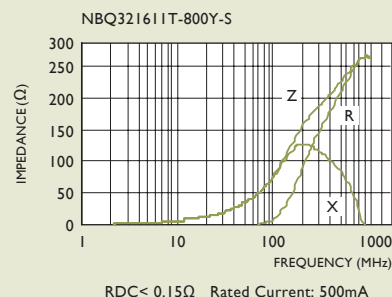
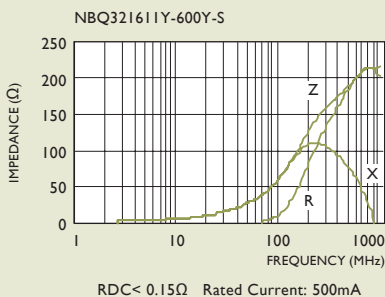
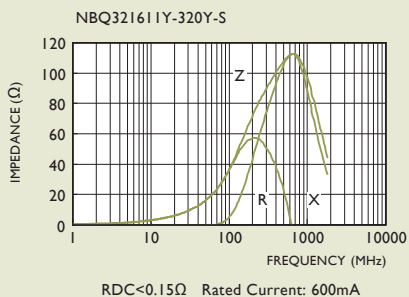



TYPICAL ELECTRICAL CHARACTERISTICS

Test Instruments : HP4291A Impedance / Material Analyzer

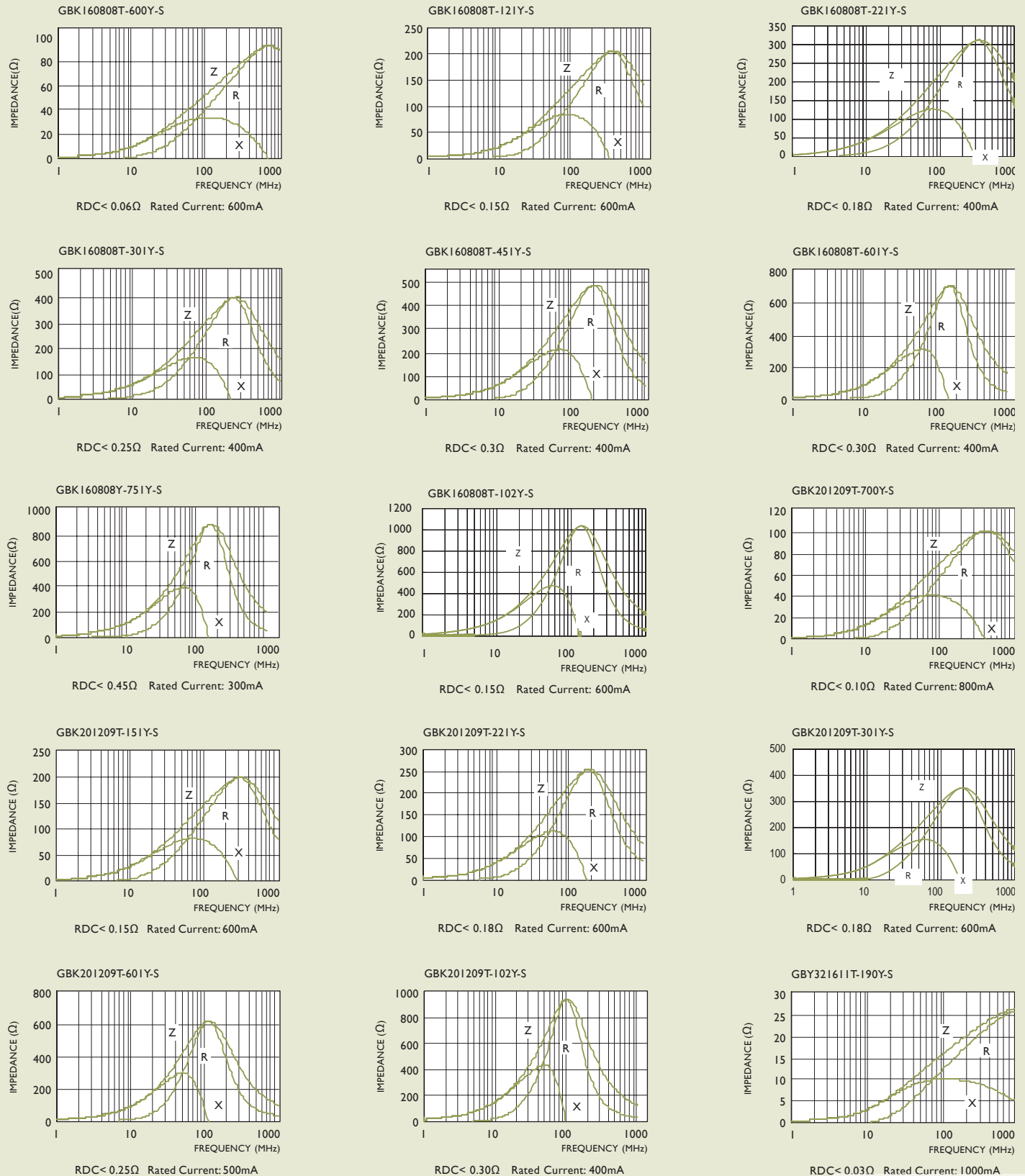



TYPICAL ELECTRICAL CHARACTERISTICS

Test Instruments : HP4291A Impedance / Material Analyzer

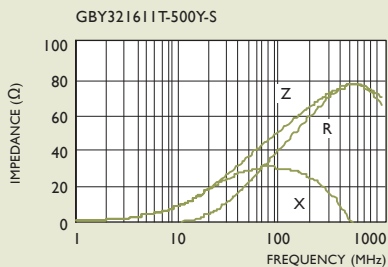

RDC < 0.06Ω Rated current: 800mA

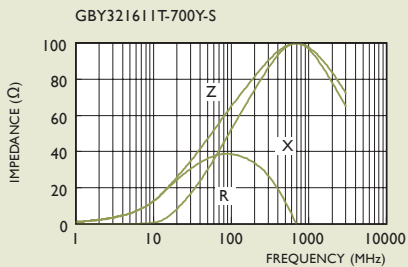

RDC < 0.06Ω Rated current: 800mA

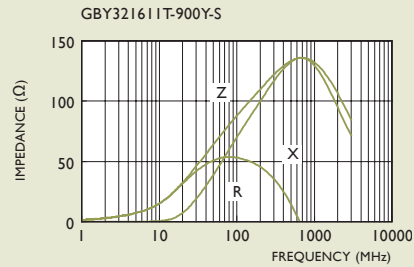

RDC < 0.10Ω Rated current: 800mA

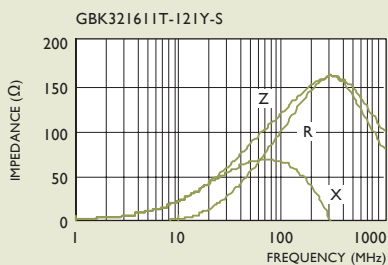

RDC < 0.10 Rated Current: 800mA

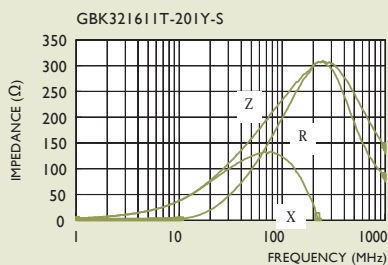

RDC < 0.15Ω Rated Current: 500mA

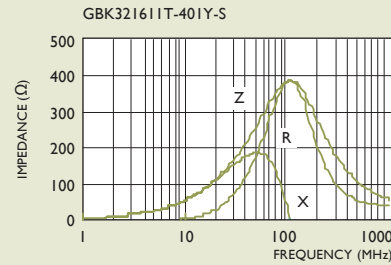

RDC < 0.15Ω Rated Current: 600mA

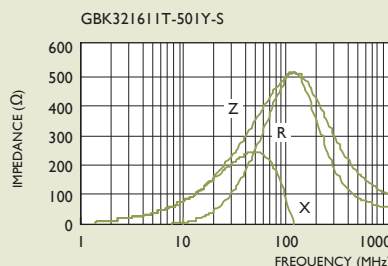

RDC < 0.15Ω Rated Current: 600mA

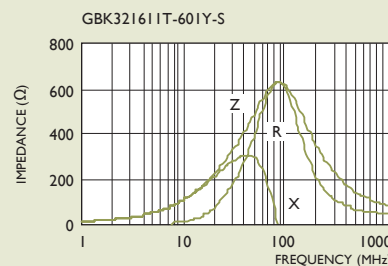

RDC < 0.20Ω Rated Current: 500mA

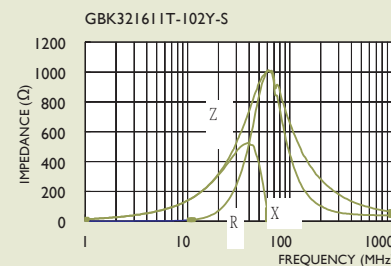

RDC < 0.25Ω Rated Current: 400mA

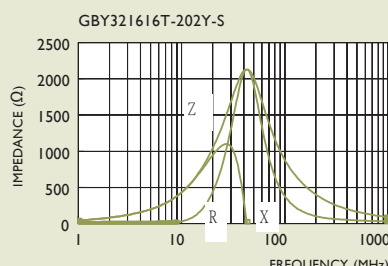

RDC < 0.35Ω Rated Current: 400mA

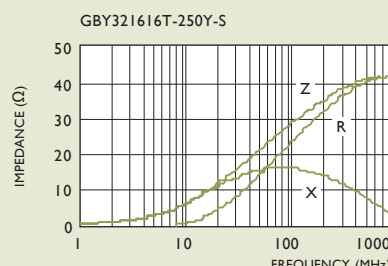

RDC < 0.10Ω Rated Current: 1000mA

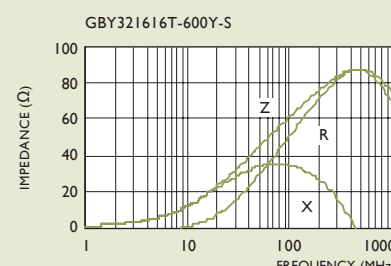

RDC < 0.10Ω Rated Current: 1000mA

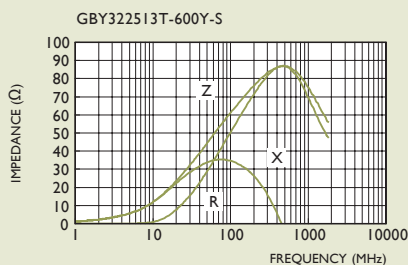

RDC < 0.10Ω Rated Current: 1000mA

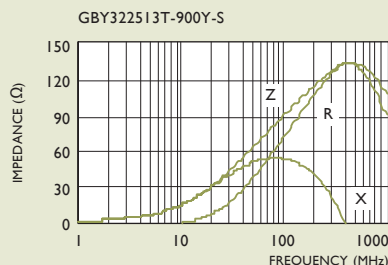

RDC < 0.10Ω Rated Current: 1000mA

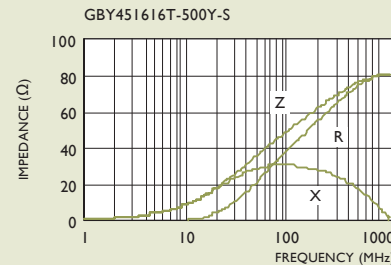

RDC < 0.10Ω Rated Current: 1000mA



TYPICAL ELECTRICAL CHARACTERISTICS

Test Instruments : HP4291A Impedance / Material Analyzer

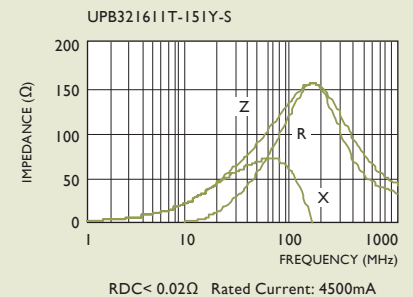
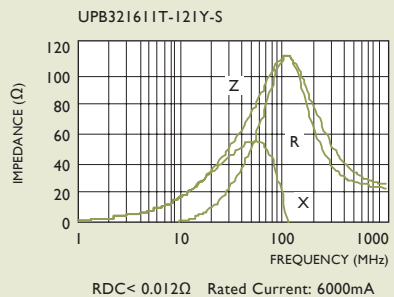
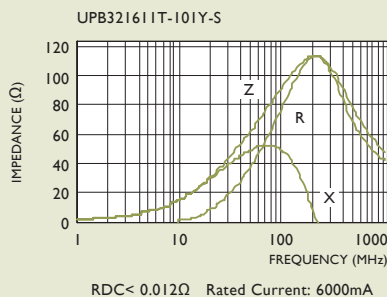
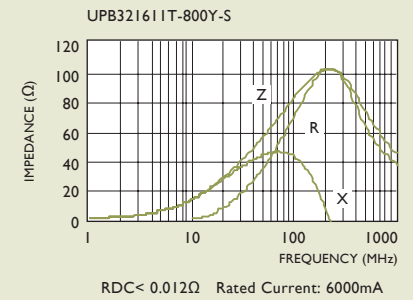
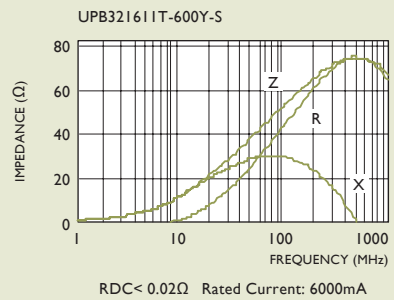
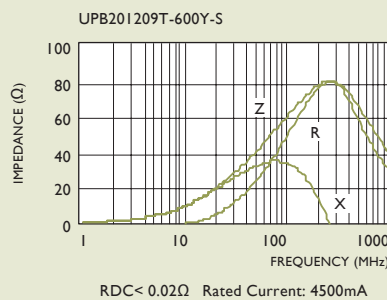
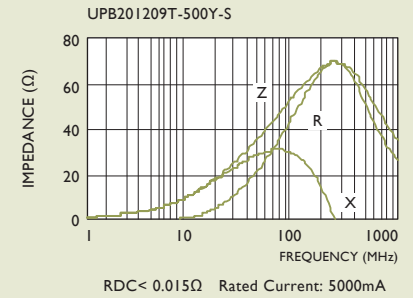
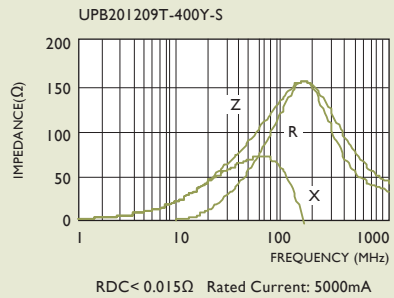
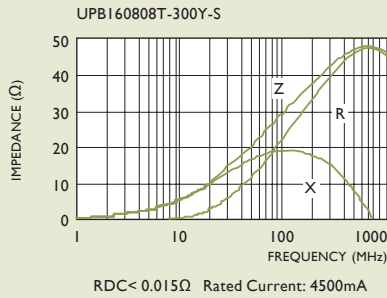
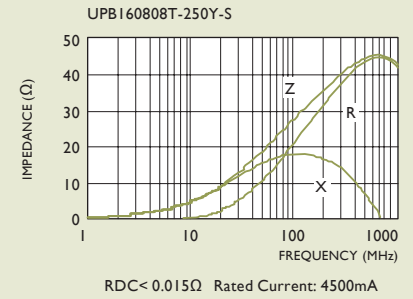
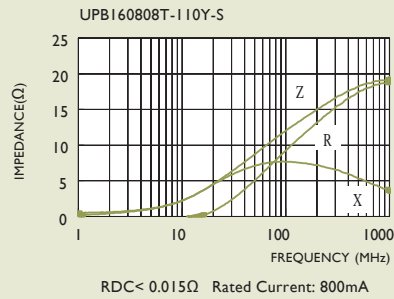
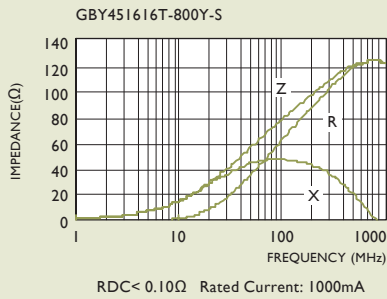
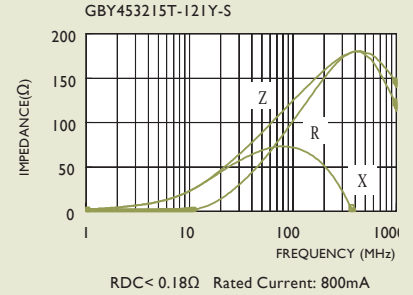
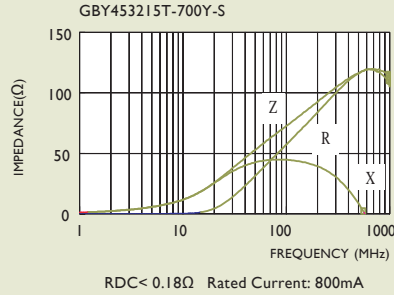
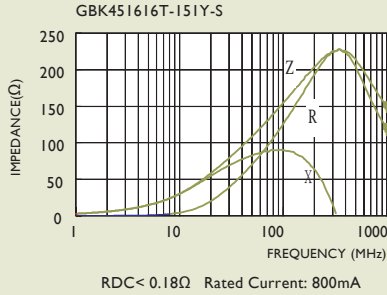



RECOMMEND SOLDERING CONDITIONS

for:CL/ CLH/ SQV/ SMD power inductors/ SMD Chip Beads/ SMD Filters, Transformers, Current Sensors

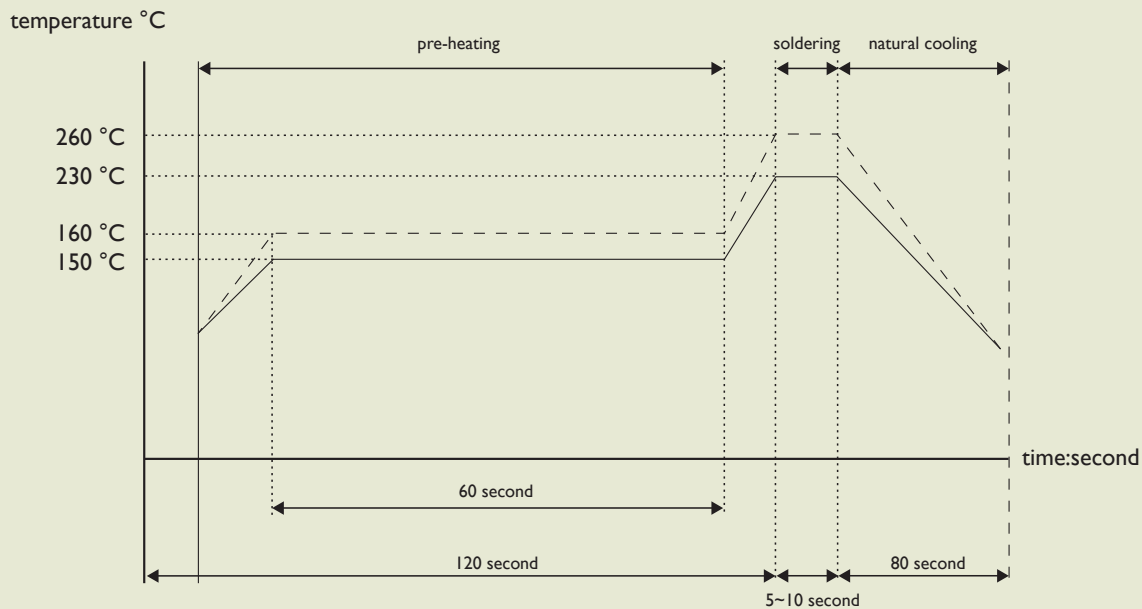

for: lead solder	———
for: lead-free solder	-----