

Operating Instructions

DVD Home Theater Sound System

Model No. **SC-HT720**
SC-HT692



The illustration shows SC-HT720 for the U.S.A. and Canada.

Before connecting, operating or adjusting this product, please read these instructions completely. Please keep this manual for future reference.



Region number

The player plays DVD-Video marked with labels containing the region number or "ALL".

Region	Number
U.S.A., Canada and units with PX printed on the outer packaging	1
Latin America	4

Example: **U.S.A. and Canada**



U.S.A. and Canada



As an ENERGY STAR® Partner,* Panasonic has determined that this product meets the ENERGY STAR® guidelines for energy efficiency.

* For Canada only: The word "Participant" is used in place of the word "Partner".



Table of contents

Getting started

IMPORTANT SAFETY INSTRUCTIONS	3
Accessories	3

Simple setup

STEP 1 Locating	4
Other speaker setup options	5
STEP 2 Connecting speakers with the subwoofer	6
STEP 3 Video connections	7
STEP 4 Radio and system connection	8
STEP 5 The remote control	8
STEP 6 QUICK SETUP	9

Control reference guide	9
Discs that can be played	10
Main unit and disc caution	11

Disc operations

Basic play	12
Convenient functions	14
Position memory/Zoom/Audio/Subtitle/Quick replay/ Page skip/Repeat play/All group, random and program play	
Using navigation menus	16
Playing data discs/Playing HighMAT™ discs/Playing the programs/Playing a play list	
Using on-screen menus	18
Changing the player settings	20

Other operations

The radio	22
Automatic presetting/Selecting the preset channels/ Manual tuning/Optional antenna connections	
Sound field and sound quality	24-26
Sound Field Control/Super Surround/Center Focus/ Dolby Pro Logic II/Down-mixing/Speaker level adjustments/Subwoofer level/Custom Sound Memory	
Other functions	27
Sleep timer/Muting/Using headphones	
Operating other equipment	28

Reference

Specifications	30
Troubleshooting guide	32
Product service/Maintenance/Glossary	34
Limited Warranty (ONLY FOR U.S.A.)	35

Dear customer

Thank you for purchasing this product. For optimum performance and safety, please read these instructions carefully.

HT720: indicates features applicable to SC-HT720 only.

HT692: SC-HT692 only.

- These operating instructions are applicable to models **SC-HT720 and SC-HT692**.
- Unless otherwise indicated, illustrations in these operating instructions are of **SC-HT720 for U.S.A. and Canada**.
- Operations in these instructions are described mainly with the remote control, but you can do the operations on the main unit if the controls are the same.

System	SC-HT720	SC-HT692
Main unit	SA-HT720	SA-HT692
Front speakers	SB-FS720	SB-FS720
Center speaker	SB-PC720	SB-PC720
Surround speakers	SB-FS520	SB-FS520
Active subwoofer	SB-WA720	SB-WA692

CAUTION!

THIS PRODUCT UTILIZES A LASER. USE OF CONTROLS OR ADJUSTMENTS OR PERFORMANCE OF PROCEDURES OTHER THAN THOSE SPECIFIED HEREIN MAY RESULT IN HAZARDOUS RADIATION EXPOSURE. DO NOT OPEN COVERS AND DO NOT REPAIR YOURSELF. REFER SERVICING TO QUALIFIED PERSONNEL.

WARNING:

TO REDUCE THE RISK OF FIRE, ELECTRIC SHOCK OR PRODUCT DAMAGE, DO NOT EXPOSE THIS APPARATUS TO RAIN, MOISTURE, DRIPPING OR SPLASHING AND THAT NO OBJECTS FILLED WITH LIQUIDS, SUCH AS VASES, SHALL BE PLACED ON THE APPARATUS.

CAUTION!

- **DO NOT INSTALL OR PLACE THIS UNIT IN A BOOKCASE, BUILT-IN CABINET OR IN ANOTHER CONFINED SPACE. ENSURE THE UNIT IS WELL VENTILATED. TO PREVENT RISK OF ELECTRIC SHOCK OR FIRE HAZARD DUE TO OVERHEATING, ENSURE THAT CURTAINS AND ANY OTHER MATERIALS DO NOT OBSTRUCT THE VENTILATION VENTS.**
- **DO NOT OBSTRUCT THE UNIT'S VENTILATION OPENINGS WITH NEWSPAPERS, TABLECLOTHS, CURTAINS, AND SIMILAR ITEMS.**
- **DO NOT PLACE SOURCES OF NAKED FLAMES, SUCH AS LIGHTED CANDLES, ON THE UNIT.**
- **DISPOSE OF BATTERIES IN AN ENVIRONMENTALLY FRIENDLY MANNER.**

For units with PX printed on the outer packaging THIS UNIT IS INTENDED FOR USE IN MODERATE CLIMATES. For Latin America THIS UNIT IS INTENDED FOR USE IN TROPICAL CLIMATES.

This product may receive radio interference caused by mobile telephones during use. If such interference is apparent, please increase separation between the product and the mobile telephone.

For areas except U.S.A. and Canada

CAUTION:

The AC voltage is different according to the area. Be sure to set the proper voltage in your area before use. (For details, please refer to page 8.)

The socket outlet shall be installed near the equipment and easily accessible or the mains plug or an appliance coupler shall remain readily operable.

THE FOLLOWING APPLIES ONLY IN THE U.S.A.

CAUTION:

This equipment has been tested and found to comply with the limits for a Class B digital device, pursuant to Part 15 of the FCC Rules.

These limits are designed to provide reasonable protection against harmful interference in a residential installation. This equipment generates, uses and can radiate radio frequency energy and, if not installed and used in accordance with the instructions, may cause harmful interference to radio communications. However, there is no guarantee that interference will not occur in a particular installation. If this equipment does cause harmful interference to radio or television reception, which can be determined by turning the equipment off and on, the user is encouraged to try to correct the interference by one or more of the following measures:

- Reorient or relocate the receiving antenna.
- Increase the separation between the equipment and receiver.
- Connect the equipment into an outlet on a circuit different from that to which the receiver is connected.
- Consult the dealer or an experienced radio/TV technician for help.

Any unauthorized changes or modifications to this equipment would void the user's authority to operate this device.

This device complies with Part 15 of the FCC Rules. Operation is subject to the following two conditions: (1) This device may not cause harmful interference, and (2) this device must accept any interference received, including interference that may cause undesired operation.

THE FOLLOWING APPLIES ONLY IN THE U.S.A. AND CANADA



CAUTION

**RISK OF ELECTRIC SHOCK
DO NOT OPEN**



CAUTION: TO REDUCE THE RISK OF ELECTRIC SHOCK, DO NOT REMOVE SCREWS. NO USER-SERVICEABLE PARTS INSIDE. REFER SERVICING TO QUALIFIED SERVICE PERSONNEL.



The lightning flash with arrowhead symbol, within an equilateral triangle, is intended to alert the user to the presence of uninsulated "dangerous voltage" within the product's enclosure that may be of sufficient magnitude to constitute a risk of electric shock to persons.



The exclamation point within an equilateral triangle is intended to alert the user to the presence of important operating and maintenance (servicing) instructions in the literature accompanying the appliance.

IMPORTANT SAFETY INSTRUCTIONS

Read these operating instructions carefully before using the unit. Follow the safety instructions on the unit and the applicable safety instructions listed below. Keep these operating instructions handy for future reference.

- 1) Read these instructions.
- 2) Keep these instructions.
- 3) Heed all warnings.
- 4) Follow all instructions.
- 5) Do not use this apparatus near water.
- 6) Clean only with dry cloth.
- 7) Do not block any ventilation openings. Install in accordance with the manufacturer's instructions.
- 8) Do not install near any heat sources such as radiators, heat registers, stoves, or other apparatus (including amplifiers) that produce heat.
- 9) **U.S.A. and Canada**
Do not defeat the safety purpose of the polarized or grounding-type plug. A polarized plug has two blades with one wider than the other. A grounding-type plug has two blades and a third grounding prong. The wide blade or the third prong are provided for your safety. If the provided plug does not fit into your outlet, consult an electrician for replacement of the obsolete outlet.
- 10) Protect the power cord from being walked on or pinched particularly at plugs, convenience receptacles, and the point where they exit from the apparatus.
- 11) Only use attachments/accessories specified by the manufacturer.
- 12) Use only with the cart, stand, tripod, bracket, or table specified by the manufacturer, or sold with the apparatus. When a cart is used, use caution when moving the cart/apparatus combination to avoid injury from tip-over. 
- 13) Unplug this apparatus during lightning storms or when unused for long periods of time.
- 14) Refer all servicing to qualified service personnel. Servicing is required when the apparatus has been damaged in any way, such as power-supply cord or plug is damaged, liquid has been spilled or objects have fallen into the apparatus, the apparatus has been exposed to rain or moisture, does not operate normally, or has been dropped.

CAUTION	- LASER RADIATION WHEN OPEN. DO NOT STARE INTO BEAM. FDA 21 CFR / Class II
CAUTION	- VISIBLE AND INVISIBLE LASER RADIATION WHEN OPEN. AVOID EXPOSURE TO BEAM. IEC60825-1 / Class 3b
WARNING	- SYNLIG OCH OSYNLIG LASERSTRÅLNING NÄR DENNA DEL ÄR ÖPPNAD. BETRÄKTA EJ STRÅLEN.
ADVARSEL	- SYNLIG OG OSYNLIG LASERSTRÅLNING VED ÅBNING. UNDGÅ UDSÆTTETSE FOR STRÅLING.
ADVARSEL	- SYNLIG OG OSYNLIG LASERSTRÅLNING NÄR DEKSEL ÄPNES. UNNGÅ EKSPONERING FÖR STRÅLEN.
VARO!	- AVAITAESSA OLET ALTIINNA NÄKYVÄÄ JA NÄKYMÄTÖN LASERSÄTELVILLE. ÄLÄ KATSO SÄTEESEEN.
VORSICHT	- SICHTBARE UND UNSICHTBARE LASERSTRÄHLUNG. WENN ABDECKUNG GEÖFFNET, NICHT DEM STRAHL AUSSETZEN.
ATTENTION	- RAYONNEMENT LASER VISIBLE ET INVISIBLE EN CAS D'OUVERTURE. EXPOSITION DANGEREUSE AU FAISCEAU.
注意	- 打开時有可见及不可见激光辐射。避免激光照射。
注意	- ここを開くと可視及び不可視レーザー光が出ます。ビームを死んだり、触れたりしないで下さい。RQLX0054

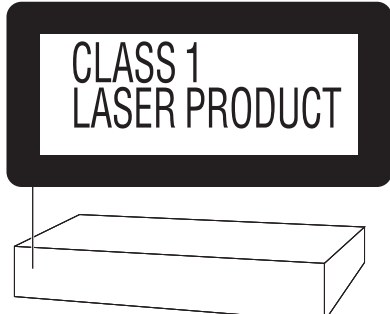

(Back of product)

The laser product label has not been attached to products for the U.S.A. and Canada

(Inside of product)

IMPORTANT SAFETY INSTRUCTIONS/Accessories

Accessories



Please check and identify the supplied accessories. Use numbers indicated in parentheses when asking for replacement parts. **Only for U.S.A.:** To order accessories, refer to "Accessory Purchases" on page 35. **For other areas:** To order accessories, call the dealer from whom you have made your purchase.

- 1 Remote control (EUR7722X40)

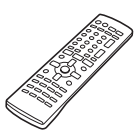

- 1 AC power supply cord **U.S.A. and Canada** (K2CB2CB00006)

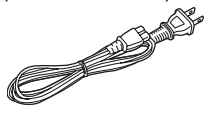

- 1 System cable (K1HA25HA0001)

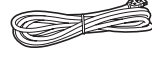

- For areas except U.S.A. and Canada**
- 1 Power plug adaptor (K2DA42E00001)

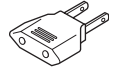

- 2 Remote control batteries

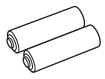

- Others** (K2CQ2CA00002)

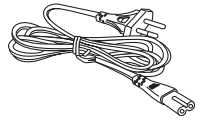

- 5 Speaker cables 3×4-m (13-foot) cables (REE1247A)



- 2×10-m (33-foot) cables (REE1247C)



Note
The included AC power supply cord is for use with this unit only. Do not use it with other equipment.

- 1 Video cable (RJL1P016B15A)



- 1 AM loop antenna (N1DAAA00001)



- U.S.A. and Canada**
- 1 Antenna plug (K2RC021B0001)

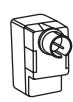

- 1 Sheet of speaker-cable stickers



- 1 FM indoor antenna (RSA0007-J)

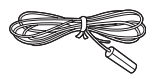

Simple setup

STEP 1 Locating

How you set up your speakers can affect the bass and the sound field. Note the following points.

- Place speakers on flat secure bases.
- Placing speakers too close to floors, walls, and corners can result in excessive bass. Cover walls and windows with thick curtains.
- The left and right speaker pairs are the same with respect to the front and surround speakers.

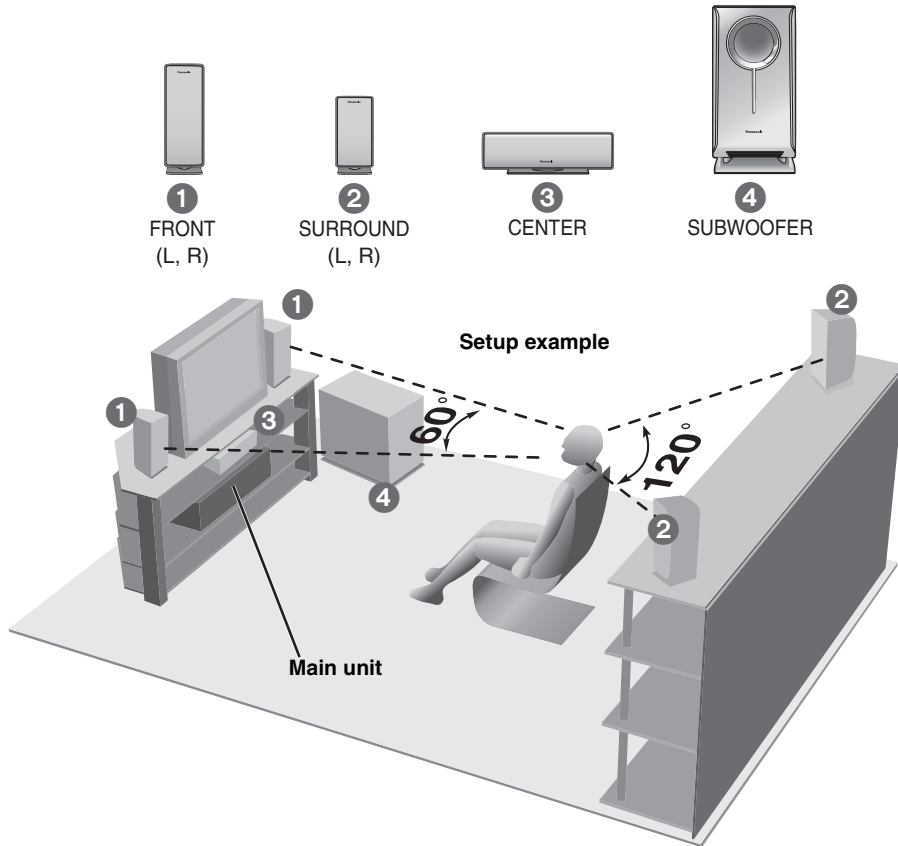

- Place the front, center, and surround speakers at approximately the same distance from the seating position. The angles in the diagram are approximate.

• Use only supplied speakers

Using other speakers can damage the unit and sound quality will be negatively affected.

- Set the speakers up on an even surface to prevent them from falling. Take proper precautions to prevent the speakers from falling if you cannot set them up on an even surface.

Main unit

Note

Keep your speakers at least 10 mm ($\frac{13}{32}$ ") away from the system for proper ventilation.

Center speaker

- Vibration caused by the center speaker can disrupt the picture if it is placed directly on the television. Put the center speaker on a rack or shelf.
- To prevent the speakers from falling, do not place directly on top of the television.

Subwoofer

Place to the right or left of the television, on the floor or a sturdy shelf so that it won't cause vibration. Leave 10 cm (4") at the rear for ventilation.

Caution

- Hold the speakers by the sides. Applying pressure to the front net can damage the speaker.

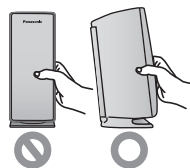

Notes on speaker use

- You can damage your speakers and shorten their useful life if you play sound at high levels over extended periods.
- Reduce the volume in the following cases to avoid damage.
 - When playing distorted sound.
 - When the speakers are receiving howling from a record player, noise from FM broadcasts, or continuous signals from an oscillator, test disc, or electronic instrument.
 - When adjusting the sound quality.
 - When turning the unit on or off.

If irregular coloring occurs on your television

The supplied speakers are designed to be used close to a television, but the picture may be affected with some televisions and setup combinations.

If this occurs, turn the television off for about 30 minutes.

The television's demagnetizing function should correct the problem. If it persists, move the speakers farther away from the television.



Caution

- The main unit and supplied speakers are only to be used as indicated in this setup. Failure to do so may lead to damage to the amplifier and/or the speakers, and may result in the risk of fire. Consult a qualified service person if damage has occurred or if you experience a sudden change in performance.
- Do not attempt to attach these speakers to walls using methods other than those described in this manual.

Other speaker setup options

■ Attaching to a wall

- 1 Drive a screw (not included) into a wall.
- 2 Fit the speaker securely onto the screw(s) with the hole(s).

- The wall or pillar on which the speakers are to be attached should be capable of supporting 10 kg (22 lb.) per screw. Consult a qualified building contractor when attaching the speakers to a wall. Improper attachment may result in damage to the wall and speakers.

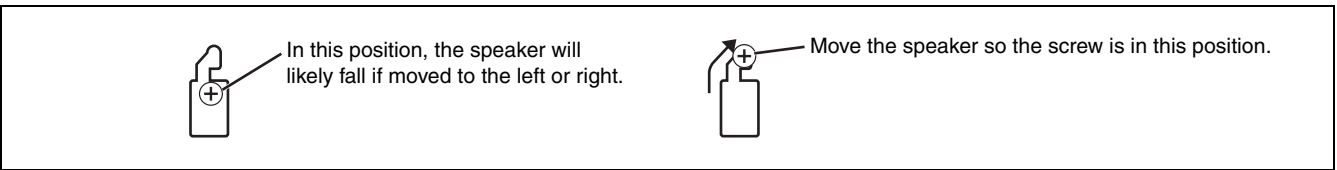
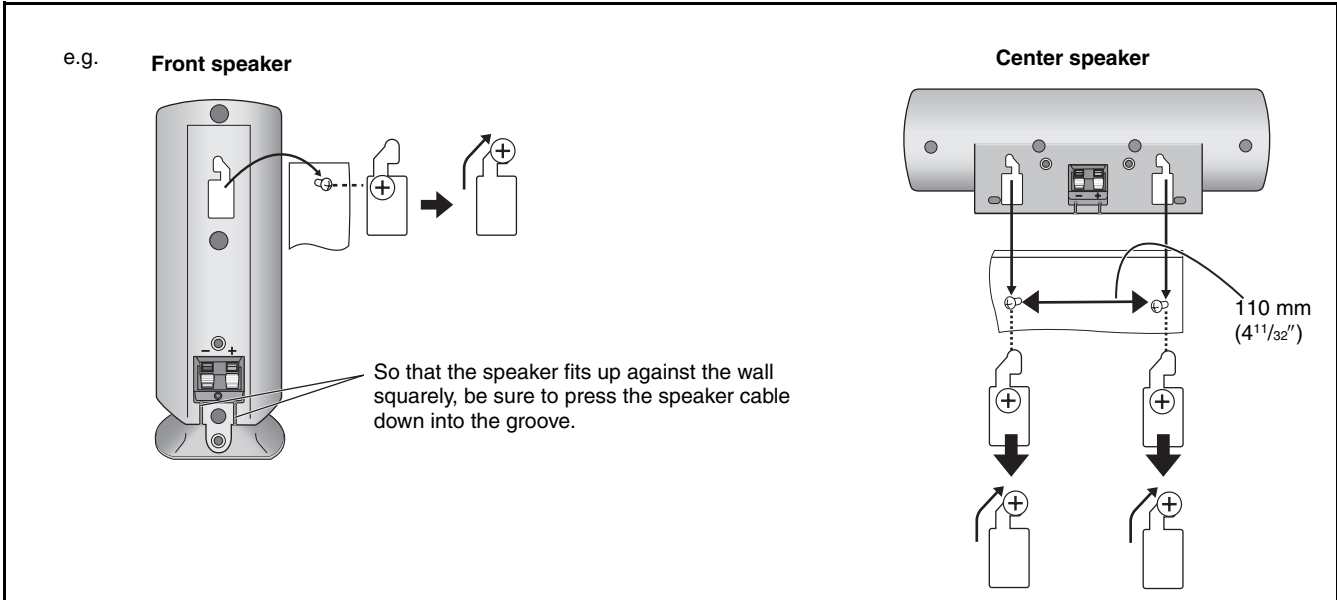
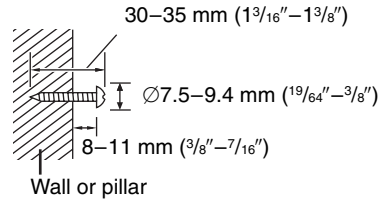

■ Fitting speaker stands (not included)

Ensure the stands meet these conditions before purchasing them.

Observe the diameter and length of the screws and the distance between screws as shown in the diagram.

- The stands must be able to support over 10 kg (22 lb.).
- The stands must be stable even if the speakers are in a high position.

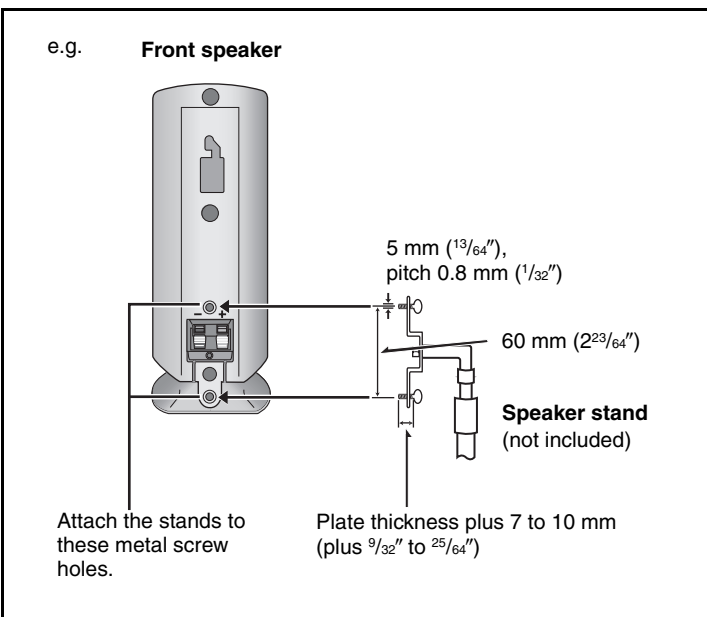

STEP 2 Connecting speakers with the subwoofer

- Attach the speaker-cable stickers to make connection easier.
- The terminals of the subwoofer have high output power. Carefully connect the speaker wires.

Speaker cables

- 4 m (13-foot) cables: For front and center speakers
- 10 m (33-foot) cables: For surround speakers



Sheet of speaker-cable stickers

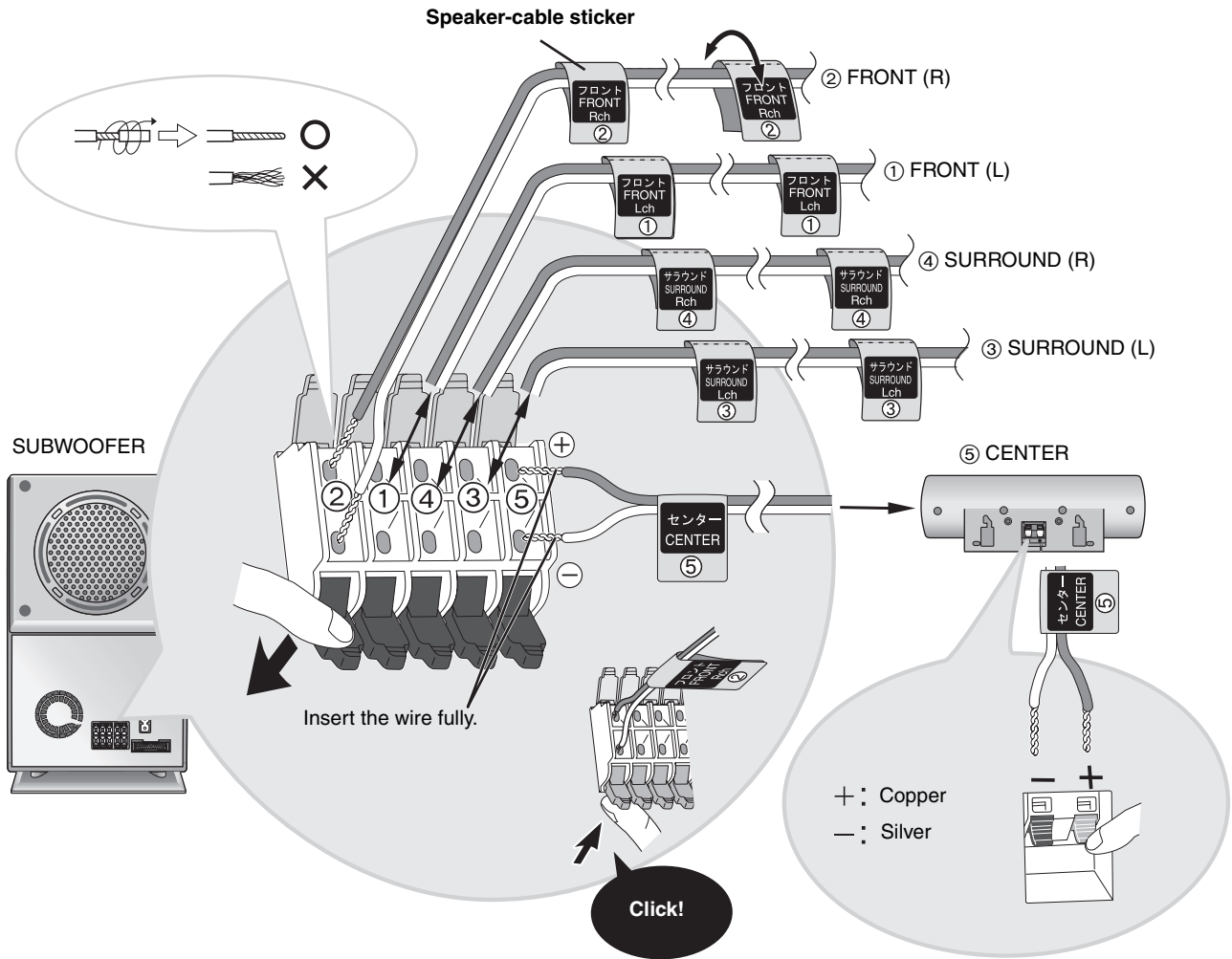

Note

- Never short-circuit positive (+) and negative (-) speaker wires.
- Be sure to connect only positive (copper) wires to positive (+) terminals and negative (silver) wires to negative (-) terminals. Incorrect connection can damage the speakers.

STEP 3 Video connections

- Do not connect through the video cassette recorder. Due to copy guard protection, the picture may not display properly.
- Turn the television off before connecting, and refer to the television's operating instructions.

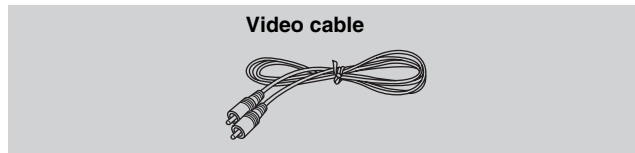

■ Television with a VIDEO IN terminal

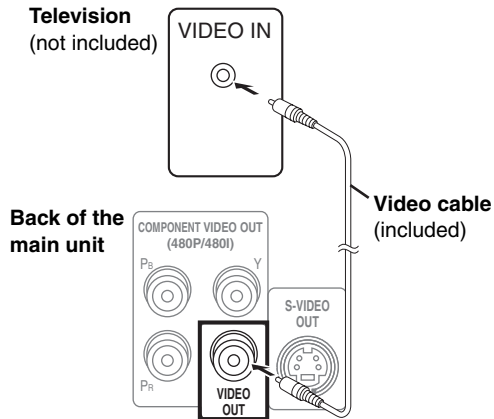

■ Television with COMPONENT VIDEO IN terminals

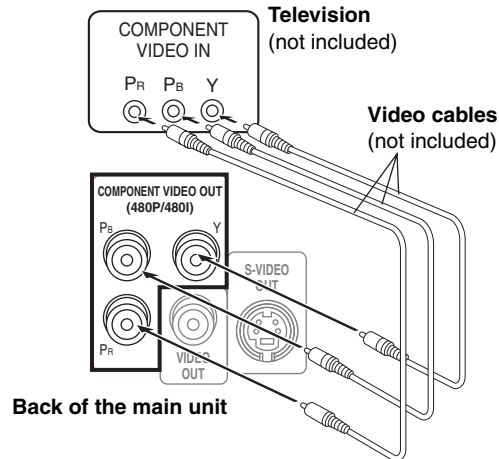

■ Television with an S-VIDEO IN terminal

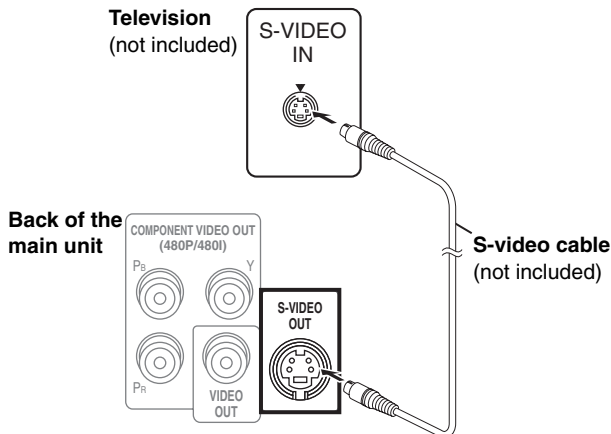

S-VIDEO OUT terminal

The S-VIDEO OUT terminal achieves a more vivid picture than the VIDEO OUT terminal by separating the chrominance (C) and luminance (Y) signals. (Actual results depend on the television.)

COMPONENT VIDEO OUT terminals

These terminals can be used for either interlace or progressive output and provide a purer picture than the S-VIDEO OUT terminal. Connection using these terminals outputs the color difference signals (P_B/P_R) and luminance signal (Y) separately in order to achieve high fidelity in reproducing colors.

- The description of the component video input terminals depends on the television or monitor (e.g. Y/P_B/P_R, Y/B-Y/R-Y, Y/C_B/C_R). Connect to terminals of the same color.
- After making this connection, select "Darker" from the "Black Level Control" in the "Video" tab (→ page 20).

To enjoy progressive video

- Connect to the component video input terminals on a 480P compatible television. (Video will not be displayed correctly if connected to an incompatible television.)
- All Panasonic televisions that have 480P input connectors are compatible. Consult the manufacturer if you have another brand of television.

STEP 4 Radio and system connection

System cable

AM loop antenna

FM indoor antenna

AC power supply cord

U.S.A. and Canada

Others

Power plug adaptor

Areas except U.S.A. and Canada

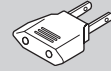
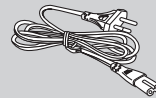
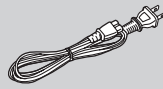
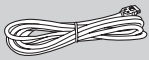

- Connect the AC power supply cord after all other connections are complete.
- Optional antenna connections (→ page 23).

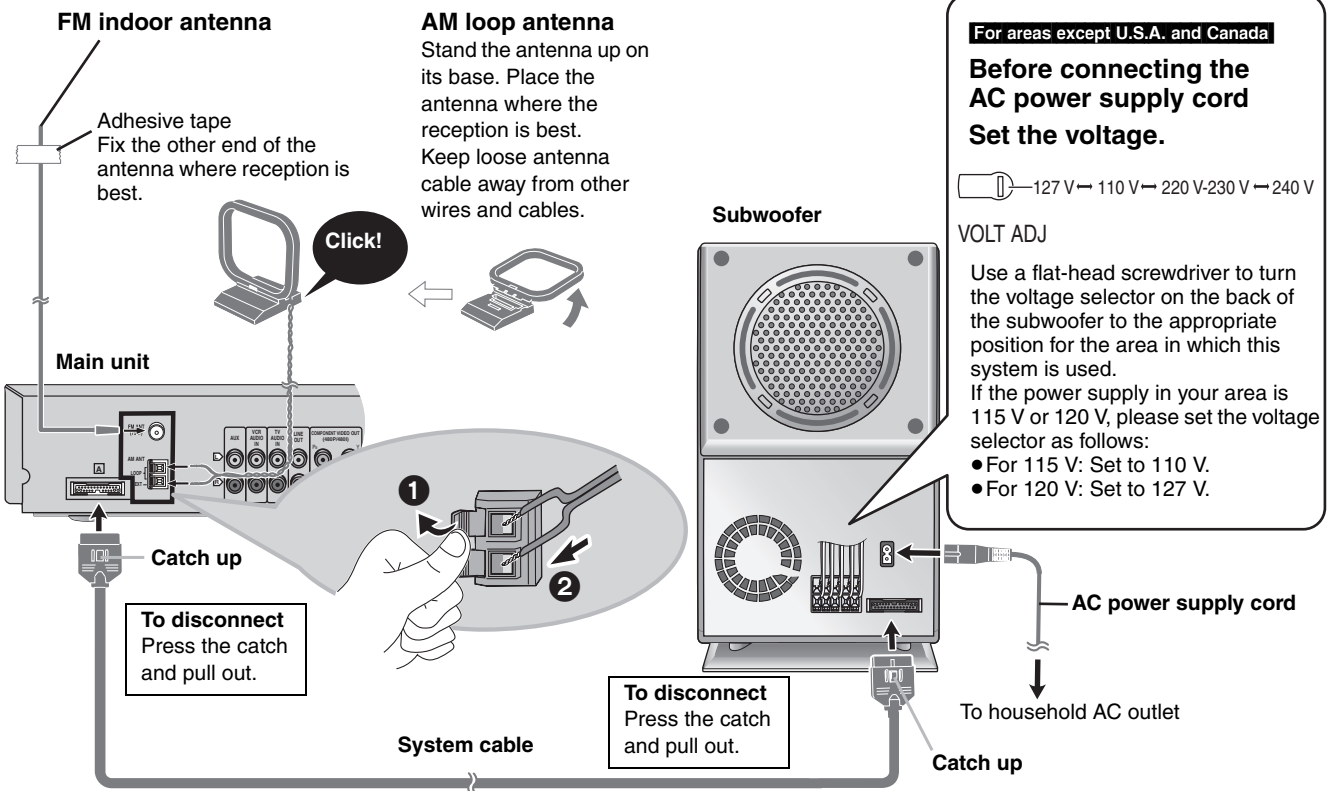

Conserving power

The main unit consumes a small amount of power, even when it is turned off (For U.S.A. and Canada: approx. 0.4 W or for units with PX printed on the outer packaging and Latin America: approx. 0.9 W). To save power when the unit is not to be used for a long time, unplug it from the household AC outlet. You will need to reset some memory items after plugging in the unit.

For areas except U.S.A. and Canada

- If the power plug will not fit your AC outlet Use the power plug adaptor (included).

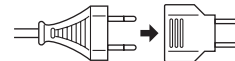

If it still doesn't fit, contact an electrical parts distributor for assistance.

STEP 5 The remote control

Remote control

Batteries

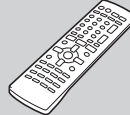

- 2 Insert so the poles (+ and -) match those in the remote control.

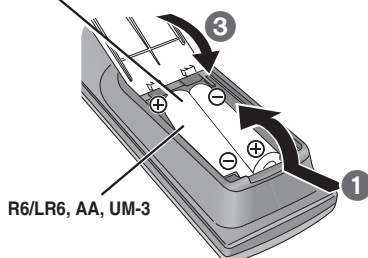

- Do not use rechargeable type batteries.

Do not:

- mix old and new batteries.
 - use different types at the same time.
 - heat or expose to flame.
 - take apart or short circuit.
 - attempt to recharge alkaline or manganese batteries.
 - use batteries if the covering has been peeled off.
- Mishandling of batteries can cause electrolyte leakage which can damage items the fluid contacts and may cause a fire.





Remove if the remote control is not going to be used for a long period of time. Store in a cool, dark place.

Use

Aim at the sensor (→ page 9), avoiding obstacles, at a maximum range of 7 m (23 feet) directly in front of the unit.

STEP 6 QUICK SETUP

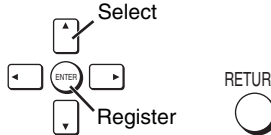
The QUICK SETUP screen assists you to make necessary settings. Turn on the television and select the appropriate video input on the television.

1  Turn on the unit.	2  Select "DVD/CD".	3  Shows QUICK SETUP screen.	4  Follow the messages and make the settings.	5  Press to finish QUICK SETUP.	6  Press to exit.
--	---	--	---	---	---

To change these settings later
 Select "QUICK SETUP" in "Others" tab (→ page 21).

Control reference guide

See reference pages in brackets.

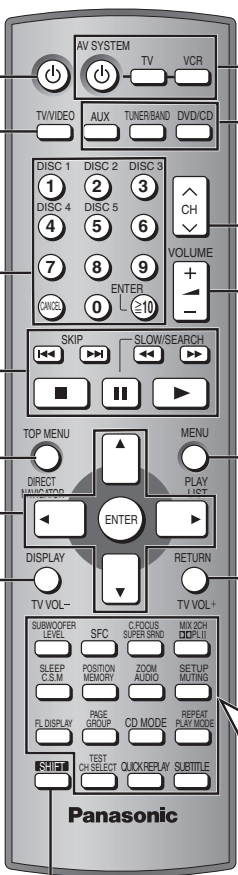

Power on/off the unit. (29)

Switch the television's video input mode. (29)
 (12, 13)

Adjust the volume. (12)

Adjust the volume. (13, 16, 17)

Adjust the volume. (9)

Adjust the volume. (18, 29)

Adjust the volume. (13, 29)

SUBWOOFER LEVEL (26)	SFC (24)	C.FOCUS SUPER SRND (24)	MIX 2CH DDP LII (24, 25)
SLEEP C.S.M. (26, 27)	POSITION MEMORY (14)	ZOOM AUDIO (14)	SETUP MUTING (20, 27)
FL DISPLAY (13)	PAGE GROUP (12, 14)	CD MODE (13)	REPEAT PLAY MODE (15)
TEST CH SELECT (25)	QUICK REPLAY (14)	SUBTITLE (14)	

To use functions labeled in orange:
 While pressing [SHIFT], press the corresponding button.

Standby/on indicator

When the unit is connected to the AC mains supply, this indicator lights up in standby mode and goes out when the unit is turned on.

Source select button [INPUT SELECTOR] (22)

DVD/CD → FM → AM → TV → VCR → AUX → Return to DVD/CD



Remote control signal sensor

Standby/on switch [⏻/I, POWER]









Press to switch the unit from on to standby mode or vice versa. In standby mode, the unit is still consuming a small amount of power.

AC supply indicator [AC IN]

This indicator lights when the unit is connected to the AC mains supply.



Discs that can be played

Disc	Logo	Indication used in operating instructions	Remarks
DVD-RAM		RAM	Recorded using Version 1.1 of the Video Recording Format (a unified video recording standard). <ul style="list-style-type: none"> Recorded with DVD-Video recorders, DVD-Video cameras, personal computers, etc. Remove TYPE 2 and 4 discs from their cartridges before use. 
		JPEG	Recorded using the DCF (Design rule for Camera File system) standard. <ul style="list-style-type: none"> Recorded with Panasonic DVD-Video recorders. To play JPEG files, select "Play as Data Disc" in Other Menu (→ page 19).
DVD-Audio		DVD-A	—
		DVD-V	Some DVD-Audio discs contain DVD-Video content. To play DVD-Video content, select "Play as DVD-Video" in Other Menu (→ page 19)
DVD-Video		DVD-V	—
DVD-R			Panasonic DVD-R recorded and finalized* on Panasonic DVD-Video recorders or DVD-Video cameras are played as DVD-Video on this unit.
Video CD		VCD	—
SVCD			Conforming to IEC62107
CD		CD	This unit is compatible with HDCD, but does not support the Peak Extend function. (A function which expands the dynamic range of high level signals) HDCD-encoded CDs sound better because they are encoded with 20 bits, as compared with 16 bits for all other CDs. <ul style="list-style-type: none"> During HDCD play, "HDCD" lights on the unit's display.
CD-R CD-RW	—	WMA MP3 JPEG CD VCD	<ul style="list-style-type: none"> This unit can play CD-R/RW (audio recording disc) recorded with the formats on the left. Close the sessions or finalize* the disc after recording. HighMAT discs WMA, MP3 or JPEG files only. To play without using the HighMAT function, select "Play as Data Disc" in Other Menu (→ page 19).

*A process that allows play on compatible equipment.

• It may not be possible to play the above discs in all cases due to the type of disc or condition of the recording.

Discs that cannot be played

PAL discs (except DVD-Audio), DVD-ROM, CD-ROM, CDV, CD-G, DVD+R, +RW, DVD-RW, SACD, Divx Video Discs and Photo CD, DVD-RAM that cannot be removed from their cartridge, 2.6-GB and 5.2-GB DVD-RAM, and "Chaoji VCD" available on the market including CVD, DVCD and SVCD that do not conform to IEC62107.

Audio format of DVDs

This unit automatically recognizes and decodes discs with these symbols.



Listening caution



Selecting fine audio equipment such as the unit you've just purchased is only the start of your musical enjoyment. Now it's time to consider how you can maximize the fun and excitement your equipment offers. This manufacturer and the Electronic Industries Association's Consumer Electronics Group want you to get the most out of your equipment by playing it at a safe level. One that lets the sound come through loud and clear without annoying blaring or distortion—and, most importantly, without affecting your sensitive hearing.

We recommend that you avoid prolonged exposure to excessive noise.

Sound can be deceiving. Over time your hearing "comfort level" adapts to higher volumes of sound. So what sounds "normal" can actually be loud and harmful to your hearing.

Guard against this by setting your equipment at a safe level BEFORE your hearing adapts.

To establish a safe level:

- Start your volume control at a low setting.
- Slowly increase the sound until you can hear it comfortably and clearly, and without distortion.

Once you have established a comfortable sound level:

- Set the dial and leave it there.

Taking a minute to do this now will help to prevent hearing damage or loss in the future. After all, we want you listening for a lifetime.

User memo:

DATE OF PURCHASE _____
 DEALER NAME _____
 DEALER ADDRESS _____

 TELEPHONE NUMBER _____

The model number and serial number of this product can be found on either the back or the bottom of the unit. Please note them in the space provided below and keep for future reference.

MODEL NUMBER _____
 SERIAL NUMBER _____

Manufactured under license from Dolby Laboratories. "Dolby", "Pro Logic" and the double-D symbol are trademarks of Dolby Laboratories.

"DTS" and "DTS Digital Surround" are registered trademarks of Digital Theater Systems, Inc.

Apparatus Claims of U.S. Patent Nos. 4,631,603, 4,577,216, and 4,819,098, licensed for limited viewing uses only.

This product incorporates copyright protection technology that is protected by method claims of certain U.S. patents and other intellectual property rights owned by Macrovision Corporation and other rights owners. Use of this copyright protection technology must be authorized by Macrovision Corporation, and is intended for home and other limited viewing uses only unless otherwise authorized by Macrovision Corporation. Reverse engineering or disassembly is prohibited.

MPEG Layer-3 audio decoding technology licensed from Fraunhofer IIS and Thomson multimedia.

Windows Media, and the Windows logo are trademarks, or registered trademarks of Microsoft Corporation in the United States and/or other countries.



WMA is a compression format developed by Microsoft Corporation. It achieves the same sound quality as MP3 with a file size that is smaller than that of MP3.



HighMAT™ and the HighMAT logo are either trademarks or registered trademarks of Microsoft Corporation in the United States and/or other countries.

HDCD®, HDCD®, High Definition Compatible Digital® and Pacific Microsonics™ are either registered trademarks or trademarks of Pacific Microsonics, Inc. in the United States and/or other countries.

HDCD system manufactured under license from Pacific Microsonics, Inc. This product is covered by one or more of the following: In the USA: 5,479,168, 5,638,074, 5,640,161, 5,808,574, 5,838,274, 5,854,600, 5,864,311, 5,872,531, and in Australia: 669114, with other patents pending.

Main unit and disc caution

■ To prevent damage

- Do not;
- load more than one disc per tray.
 - touch the drawer or the carousel while they are in motion.
 - rotate the carousel by hand.
 - close the drawer by hand.

■ To clean discs

DVD-A DVD-V VCD CD

Wipe with a damp cloth and then wipe dry.

RAM DVD-R

- Clean with an optional DVD-RAM/PD disc cleaner (LF-K200DCA1, where available).
- Never use cloths or cleaners for CDs, etc.



■ Disc handling precautions

- Do not attach labels or stickers to discs (This may cause disc warping, rendering it unusable).
- Do not write on the label side with a ball-point pen or other writing instrument.
- Do not use record cleaning sprays, benzene, thinner, static electricity prevention liquids or any other solvent.
- Do not use scratch-proof protectors or covers.
- Do not use the following discs:
 - Discs with exposed adhesive from removed stickers or labels (rented discs, etc).
 - Discs that are badly warped or cracked.
 - Irregularly shaped discs, such as heart shapes.

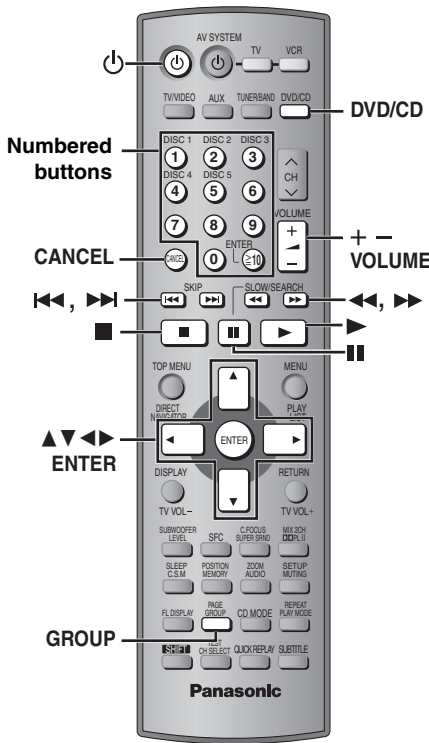

1 Power on.

POWER

2 Select "DVD/CD".

INPUT SELECTOR

3 Open the drawer and place the disc(s).

- Load double-sided discs so the label for the side you want to play is facing up.
- To load discs on the other trays, press [DISC SKIP] on the main unit.
- Play will start from the disc in the front-left position.

4 Close the drawer.

A disc indicator lights to show the tray is in the play position.

5 Start play.

When the disc finishes playing: If the next disc doesn't start playing, select the disc (→ page 13, Disc selection).

6 Adjust the volume.

DOWN UP

Press to skip. Press and hold to search.

Progressive video

Main unit only

PROGRESSIVE

Stop

The position is memorized while "RESUME" is on the display.

- Press [▶] (play) to resume.
- **DVD-V** To review the **previous chapters** (→ page 14, Position memory)
- Press [■] to clear the position.

Pause

- Press [▶] (play) to start play.

Skip

WMA MP3 JPEG

[▲ ▼]: Group skip during play

[◀ ▶]: Content skip during play

Search (during play)

Slow-motion (during pause)

- Up to 5 steps.
- Press [▶] (play) to start play.
- **VCD** Slow motion, forward direction only.

Frame-by-frame (during pause)

- **VCD** Forward direction only.

On-screen item select

Select

Register

Enter number

RAM DVD-A DVD-V VCD CD

e.g. To select 12:
[≥10] → [1] → [2]

VCD with playback control

While stopped, press the numbered buttons.

WMA MP3 JPEG

e.g. To select 123:
[1] → [2] → [3] → [ENTER]

- Press [CANCEL] to cancel the number(s).

Starting play from a selected group (while stopped)

DVD-A WMA MP3 JPEG

A folder on WMA/MP3 and JPEG discs is treated as a "Group".

PAGE GROUP →

Select

Register

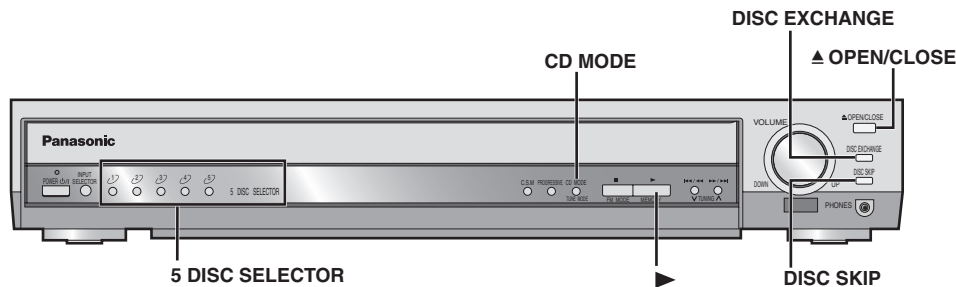
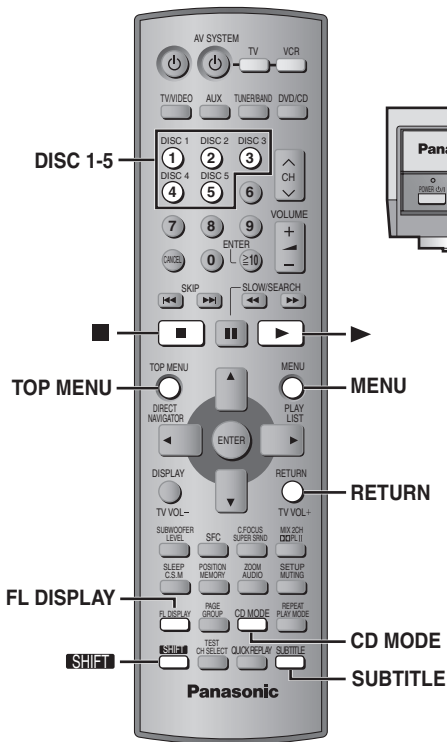

Disc menu	<p>TOP MENU Shows a disc top menu</p> <p>MENU Shows a disc menu</p> <p>RETURN Shows a disc menu</p>
Return to previous screen	<p>RETURN</p>
Main unit display	<p>RAM DVD-A DVD-V WMA MP3 Time display ↔ Number display</p> <p>JPEG When Slideshow is on: SLIDE ↔ Number display When Slideshow is off: PLAY ↔ Number display</p>
Information screen	<p>WMA MP3 JPEG CD (CD text only) Turns the information screen on/off.</p>
Disc selection	<p>• You can also select the disc with 5 DISC SELECTOR buttons on the main unit.</p> <p>SHIFT +</p> <p>DISC 1 DISC 2 DISC 3 1 2 3 DISC 4 DISC 5 4 5</p>
Skipping to the next disc tray	<p>Main unit only • While the drawer is closed Each time you press the button, the carousel moves clockwise by one tray.</p> <p>DISC SKIP</p>

Changing the other discs without interrupting play

Main unit only

- The carousel moves one tray clockwise and each subsequent press moves it two trays in alternate directions.

▲ OPEN/CLOSE

↓

DISC SKIP

Exchanging the discs in the play position

Main unit only

- The drawer opens and the disc in the play position comes to the front-left position.
- Press the button again to play the disc after changing the disc in the front-left position.

DISC EXCHANGE

CD Mode (CD sequential play) (while stopped)

VCD CD WMA MP3

This feature is very convenient if you want to play several music CDs sequentially. DVD and JPEG files are skipped without being played.

CD MODE

↓

▶

- HighMAT menus and Video CD playback control are disabled.
- You cannot change the mode during play, program or random play.
- If you want to play a DVD, press [CD MODE] again to cancel CD Mode. (CD Mode is also canceled when you switch the unit to standby.)

Note
Discs continue to rotate while menus are displayed. Press [■] when you finish to preserve the unit's motor and your television screen.

If you are experiencing problems, refer to troubleshooting (→ page 32, 33).

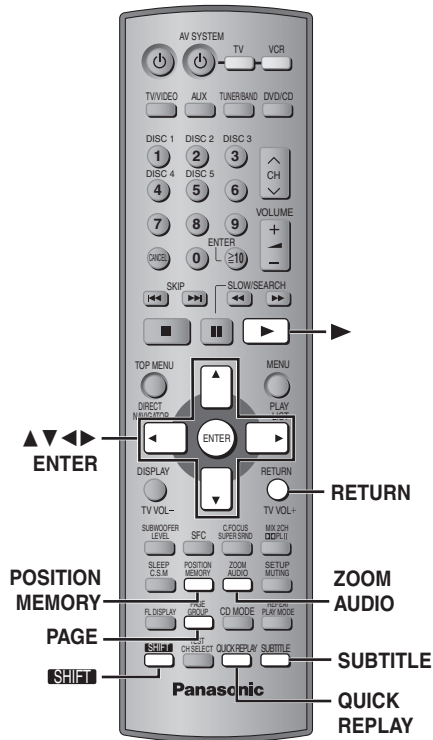

Position memory

Memorizes the position to resume play.

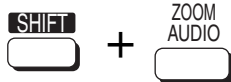

Zoom

Expands the letterbox picture to fit the screen.



Audio

Changes the soundtrack.



Subtitle

Changes the subtitle language.



Quick replay

Replays a scene.



Page skip

Selects still pictures.

See below for details.



Position memory

(Only when the elapsed play time can be displayed)
JPEG: Works with all JPEG content.)

This position is memorized even after turning off the unit, changing the source or moving the disc out of the play position.

Press **[POSITION MEMORY]**.

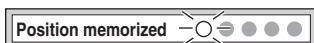

- Up to 5 discs.
- When the sixth disc is memorized, the earliest position is replaced.
- You cannot recall the position in CD Mode (→page 13).

When the unit is turned on, reselect "DVD/CD" or the disc comes to the play position, "RESUME" displays.

Press **[▶] (play)** to start play from that position.

To review the previous chapters **DVD-V**

Press **[▶] (play)** while the following message is displayed.

Press **PLAY** to preview chapters

or

Press **PLAY** to Chapter Review

The beginning portions of each chapter up to the current one are played.

- Do not press **[▶] (play)** if you want to cancel review.

Zoom

RAM DVD-V VCD

Press **[SHIFT] + [ZOOM]** several times to select the preset aspect ratio or "Auto". (Just Fit Zoom)



Fine adjustments (Manual Zoom)

Press **[◀ ▶]**.

–from ×1.00 to ×1.60 (in 0.01 units)

–from ×1.60 to ×2.00 (in 0.02 units)

- Press and hold **[◀ ▶]** to alter faster.

Audio

DVD-A DVD-V (with multiple soundtracks) **RAM VCD**

Press **[AUDIO]** several times to select the soundtrack.

RAM VCD

You can use this button to select "L", "R" or "LR".

DVD-V (Karaoke discs)

Press **[◀ ▶]** to select "On" or "Off" of vocals.

Read the disc's instructions for details.



Subtitle

DVD-V (with multiple subtitles) **VCD** (SVCD only)

RAM (On/Off only)

Press **[SUBTITLE]** several times to select the subtitle language.



To clear/display the subtitles

Press **[◀ ▶]** to select "On" or "Off".

Quick replay

(Only when the elapsed play time can be displayed)

Press **[QUICK REPLAY]** to skip back a few seconds.

Page skip

DVD-A

During play or while paused

Press **[SHIFT] + [PAGE]**.

The page changes each time you do this.

- Press **[RETURN]** to go back to page 1.

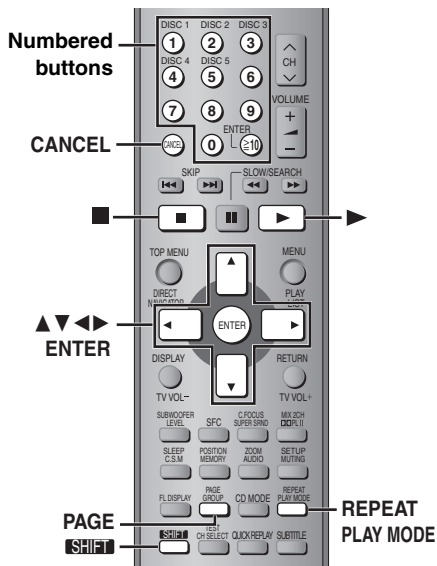

Repeat play

All group, random and program play

Each time you press the button while stopped:

DVD-A DVD-V WMA MP3 JPEG

All group (**DVD-A**) → Program → Random → off (Normal play)

VCD CD (There is no on-screen display.)

Program → 1-DISC random → ALL-DISC random → off (Normal play)

To exit all group, program and random mode

Press [PLAY MODE] several times while stopped.

- Disable HighMAT disc play to use random and program play. Select "Play as Data Disc" in Other Menu (→page 19).

- **DVD-A** Some discs contain bonus groups. If a password screen appears after selecting a group, enter the password with the numbered buttons to play the bonus group. Refer also to the disc's jacket.

See below for details.

Repeat play

(Only when the elapsed play time can be displayed)

JPEG: Works with all JPEG content.)

During play

Press **[SHIFT]** + **[REPEAT]** several times to select an item to be repeated.



RAM: PG REPEAT → ALL REPEAT (Entire disc) → REPEAT OFF

- During play list play: SCENE REPEAT → PL REPEAT → REPEAT OFF

DVD-A: TRACK REPEAT → GROUP REPEAT* → REPEAT OFF

DVD-V: CHAPTER REPEAT → TITLE REPEAT* → REPEAT OFF

VCD CD (There is no on-screen display.)

TRACK REPEAT → ALL REPEAT (Entire disc) → REPEAT OFF

WMA MP3 (There is no on-screen display.)

CONTENT REPEAT → GROUP REPEAT* → REPEAT OFF

JPEG (There is no on-screen display.)

GROUP REPEAT* → REPEAT OFF

*During all group (**DVD-A**), program and random play "ALL REPEAT" is displayed.

All group, random and program play

All group play

DVD-A

Press **[▶]** (play).



Random play

VCD CD (There is no on-screen display.)

1-DISC: You can play all the items on a disc in the play position in random order.

ALL-DISC: You can play all the items on all the discs in random order.

DVD-A DVD-V WMA MP3 JPEG

You can play selected item(s) on a disc in the play position in random order.

e.g. **DVD-V**

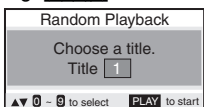

- 1 **DVD-A DVD-V WMA MP3 JPEG**
Press the numbered buttons to select a title or a group (**WMA MP3 JPEG**) then press **[ENTER]**.

DVD-A

- To enter all groups, press **[◀▶]** to select "All" and press **[ENTER]**.

- To deselect a group, press the numbered buttons corresponding to the group you want to clear.

- 2 Press **[▶]** (play).

- You can play a maximum of 999 audio/picture contents in random order.

Program play (up to 24 items)

VCD CD (There is no on-screen display.)

e.g. **DVD-V**

You can program all the items on discs.

DVD-A DVD-V WMA MP3 JPEG

You can program all the items on a disc in the play position.

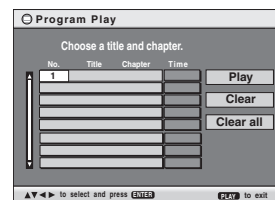

- 1 **VCD CD**
Press **[SHIFT]** + (**[DISC1]**–**[DISC5]**).

- 2 Press the numbered buttons to select the items (**WMA MP3 JPEG**) then press **[ENTER]**.

e.g. **CD**



Disc No. Track No. Program No.

- To select a 2-digit number

e.g. To select 25: **[≥10]** → **[2]** → **[5]**

WMA MP3 JPEG **[2]** → **[5]** → **[ENTER]**

- Repeat this step to program other items.
- **VCD CD** Step 1 is unnecessary when programming tracks on the same disc.

- **DVD-A DVD-V WMA MP3 JPEG**

To select an item using the cursor buttons

Press **[ENTER]** and **[▲▼]** to select an item, then press **[ENTER]** again to register. All the items in the selected disc, title or group are selected when you select "ALL".

- 3 Press **[▶]** (play).

To add or change the program

VCD CD (Add only): Repeat steps 1 and 2.

DVD-A DVD-V WMA MP3 JPEG

Press **[▲▼]** to select an item, then repeat step 2.

- Press **[SHIFT]** + **[PAGE]** to skip 8 lines at a time.

To clear an item

VCD CD Press **[CANCEL]**.

DVD-A DVD-V WMA MP3 JPEG

- 1 Press **[▲▼]** to select an item.

- 2 Press **[CANCEL]** (or press **[▲▼◀▶]** to select "Clear" and press **[ENTER]**).

To clear the whole program

VCD CD Press **[■]** so "CLEAR" is displayed.

DVD-A DVD-V WMA MP3 JPEG

Press **[▲▼◀▶]** to select "Clear all" and press **[ENTER]**.

Note

- **DVD-V WMA MP3 JPEG** Times are not displayed while programming.
- **VCD CD** Items the unit cannot find can be programmed but are canceled during play. This is also the case if you program DVD-RAM, DVD-Audio, DVD-Video, WMA, MP3 and JPEG.
- The program is cleared when you switch the unit to standby, select another source, exit the program mode by pressing **[PLAY MODE]** or move the disc out of the play position.

VCD CD The program is retained in memory.

Using navigation menus

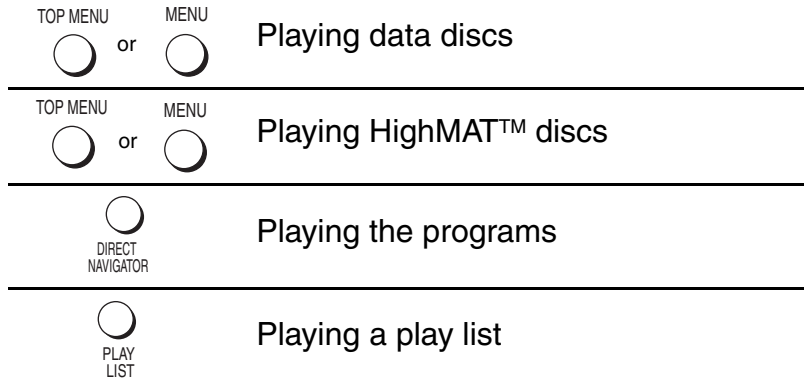
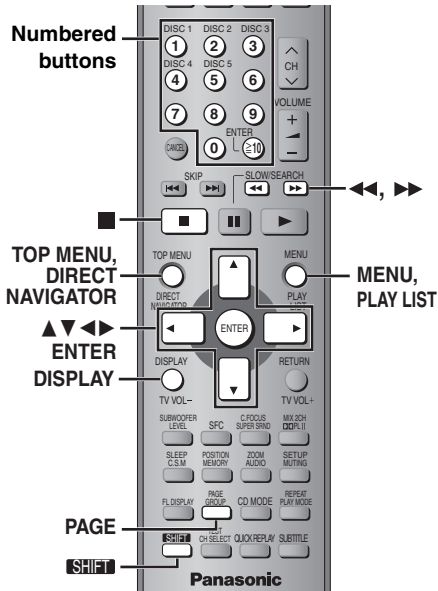

See below and the following page for details.



Playing data discs

WMA MP3 JPEG

You can play JPEG files on DVD-RAM or play HighMAT discs without using the HighMAT function (→ page 19, "Play as Data Disc" in Other Menu).

■ Using playback menus (except JPEG files on DVD-RAM)

- 1 Press [TOP MENU].
- 2 Press [▲ ▼] to select "All", "Audio" or "Picture" and press [ENTER].

•To exit the screen
Press [TOP MENU].

■ Using navigation menus

- 1 Press [MENU].
- 2 Press [▲ ▼ ◀ ▶] to select the group or audio/picture content and press [ENTER].

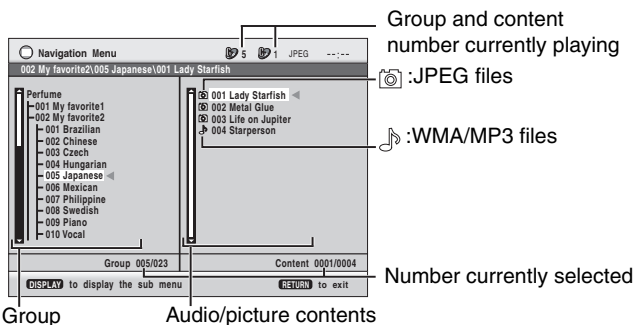

•To enjoy listening to WMA/MP3 contents while showing a JPEG image on the screen

Select a JPEG file first, and then select tracks.
(The opposite order is not effective.)

•To exit the screen
Press [MENU].

To use the contents screen to find a track

CD (CD text only)

- 1 Press [TOP MENU] or [MENU].
- 2 Press [▲ ▼] to move through the tracks and press [ENTER].

•Press [SHIFT] + [PAGE] to skip 10 lines at a time.

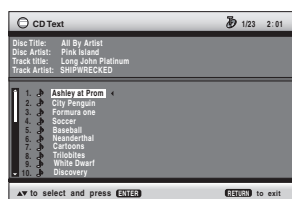

Using the submenu WMA MP3 JPEG

- 1 While the menu is displayed
Press [DISPLAY].
Items shown differ depending on the type of software.

Multi	Groups and content
List	Contents only
Tree	Groups only
Thumbnail	Thumbnail images JPEG
Next group	To go to next groups WMA MP3
Previous group	To go to previous groups WMA MP3
All	WMA/MP3 and JPEG files
Audio	WMA/MP3 files only
Picture	JPEG files only
Help display	To switch between guide messages and the elapsed play time indicator
Find	To search by content or group title (→below)

- 2 Press [▲ ▼] to select the sub menu and press [ENTER].

■ Searching by content or group title WMA MP3 JPEG

Place the cursor on the group title to search a group, or place the cursor on the content title to search contents.

- 1 Select "Find" (→ above).



- 2 Press [▲ ▼] to select a character and press [ENTER].
 - Repeat to enter another characters.
 - Lower case is also searched.
 - Press [◀ ▶] to skip between A, E, I, O and U.
 - Press [◀] to erase a character.
 - Erase the asterisk (*) to search for the titles starting with that character.
- 3 Press [▶] to select "Find" and press [ENTER].
The search result screen appears.
- 4 Press [▲ ▼] to select the content or group and press [ENTER].

Playing HighMAT™ discs

WMA MP3 JPEG

- 1 While stopped
Press [TOP MENU].
- 2 Press [▲ ▼ ◀ ▶] to select the item following the on-screen instructions.

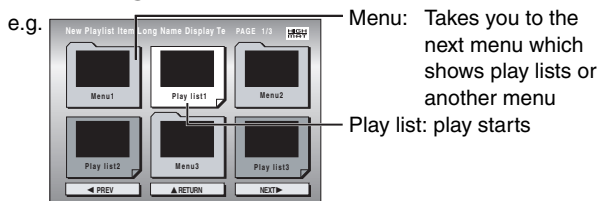

- To change the menu background
Press [DISPLAY].
The background changes to the one recorded on the disc.
- To exit the screen
Press [■].

■ Selecting from the list

- 1 During play
Press [MENU].
- 2 Press [◀] then [▲ ▼] to switch among Playlist, Group and Content lists.
- 3 Press [▶] then [▲ ▼] to select an item and press [ENTER].
• Press [SHIFT] + [PAGE] to skip 10 lines at a time.

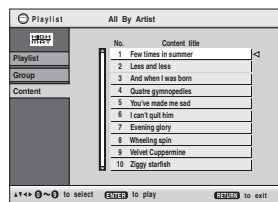

- To exit the screen
Press [MENU].

Playing the programs

RAM

- 1 Press [DIRECT NAVIGATOR].
• Titles appear only if you have entered them.
• You cannot change program and disc titles.
- 2 Press [▲ ▼] or the numbered buttons to select the program.
• Press [SHIFT] + [PAGE] to skip 5 lines at a time.
• To select a 2-digit number
e.g. 23: [≥10] → [2] → [3]
• Press [▶] to show the contents of the program and the disc.
- 3 Press [ENTER].
• To exit the screen
Press [DIRECT NAVIGATOR].

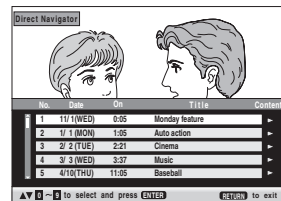

Playing a play list

RAM

(Only when the disc contains a play list)

- 1 Press [PLAY LIST].
- 2 Press [▲ ▼] or the numbered buttons to select the play list.
• Press [SHIFT] + [PAGE] to skip 10 lines at a time.
• To select a 2-digit number
e.g. 23: [≥10] → [2] → [3]
- 3 Press [ENTER].
• To exit the screen
Press [PLAY LIST].



Tips for making WMA/MP3 and JPEG discs (For CD-R, CD-RW)

- Discs must conform to ISO9660 level 1 or 2 (except for extended formats).
- This unit is compatible with multi-session but if there are a lot of sessions it takes more time for play to start. Keep the number of sessions to a minimum to avoid this.

Naming folders and files

At the time of recording, prefix folder and file names with 3-digit numbers in the order you want to play them (this may not work at times).

Files must have the extension:

“.WMA” or “.wma”

“.MP3” or “.mp3”

“.JPG”, “.jpg”, “.JPEG” or “.jpeg”

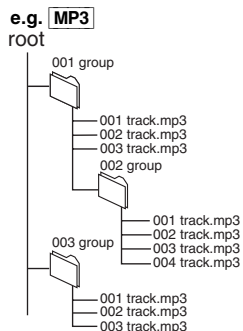

WMA

- You cannot play WMA files that are copy protected.

MP3



- This unit is not compatible with ID3 tags.
- Compatible sampling rate: 8, 11.02, 12, 16, 22.05, 24, 32, 44.1 and 48 kHz.

JPEG

- To view JPEG files on this unit:
 - Take them on a digital camera that meets the DCF Standard (Design rule for Camera File system) Version 1.0. Some digital cameras have functions that are not supported by the DCF Standard Version 1.0 like automatic picture rotation which may render a picture un-viewable.
 - Do not alter the files in any way or save them under a different name.
- This unit cannot display moving pictures, MOTION JPEG and other such formats, still pictures other than JPEG (e.g. TIFF) or play associated sound.

Using on-screen menus

(Refer to page 9 for remote control button positions.)

<p>1</p> <p style="text-align: center;">DISPLAY </p> <p style="text-align: center;">Press once. (When pressed twice, the elapsed play time indicator appears → below.) Items shown differ depending on the type of software.</p>	<p>2</p> <p style="text-align: center;">Select Go to the next menu Return to the previous menu Register Select the menu.</p>	<p>3</p> <p style="text-align: center;">Select Register Make the settings.</p> <div style="text-align: right; font-size: small;"> DISC 1 ① ② ③ DISC 4 ④ ⑤ ⑥ DISC 5 ⑦ ⑧ ⑨ ⑩ ENTER L (10) </div>	<p>4</p> <p style="text-align: center;">DISPLAY </p> <p style="text-align: center;">Press to exit.</p>
---	---	--	--

Main Menu

Program Group	To start from a specific item	Still Picture	To switch still picture
Title		Thumbnail	To show thumbnail images
Chapter		Subtitle	(→ page 14)
Track		Marker (VR)	RAM To recall a marker recorded on DVD-Video recorders To recall a marker: [▲ ▼] → [ENTER]
Playlist		Angle	(with multiple angles) To select the angle
Content		Rotate Picture	To rotate pictures
Time	To skip incrementally or decrementally (Time Slip) 1 Press [ENTER] twice to show Time Slip indicator. 2 Press [▲ ▼] to select the time and press [ENTER]. • Press and hold [▲ ▼] to alter faster. To start from a specific time (Time Search) To change remaining/elapsed time display	Slideshow	To turn on/off slideshow To change the slideshow timing (0–30 sec)
Audio	(→ page 14) [WMA] [MP3] To display the current bitrate or sampling frequency		

■ Elapsed play time indicator

(Except [JPEG]) Condition—play, pause, or slow/search Current position



Current playback item

Press [▲ ▼] to select the elapsed play time or the remaining time.

Other Settings

Play Speed	DVD-A (Motion picture part) RAM DVD-V To change play speed –from ×0.6 to ×1.4 (in 0.1 unit steps) • After you change the speed – Output is in stereo. – Sampling frequency of 96 kHz is converted to 48 kHz.	Marker	(Except RAM) To mark up to 5 positions to play again Press [ENTER] (The unit is now ready to accept markers.) To mark a position: [ENTER] (at the desired point) To mark another position: [◀▶] → [ENTER] To recall a marker: [◀▶] → [ENTER] To erase a marker: [◀▶] → [CANCEL] • This feature does not work during program and random play.
Play Menu	(Only when the elapsed play time can be displayed.) [JPEG]: Works with all JPEG content.)		
Repeat	(→ page 15)		
A-B Repeat	Except [JPEG] RAM (Still picture part) To repeat a specified section Press [ENTER] at the starting and ending points. Press [ENTER] again to cancel.		

Picture Menu

Picture Mode	Normal Cinema1: Mellows images and enhances detail in dark scenes. Cinema2: Sharpens images and enhances detail in dark scenes. Animation Dynamic User (Press [ENTER] to select "Picture Adjustment") (→ below)
	Picture Adjustment Contrast Brightness Sharpness Color Gamma: Adjusts the brightness of dark parts. Depth Enhancer Reduces the rough noise in the background to give a greater feeling of depth. This does not work while using Cinema 1 or 2 (→ above).
Video Output Mode	480I (Interlace) ↔ 480P (Progressive)
Transfer Mode	If you have chosen "480P" (→ above), select the method of conversion for progressive output to suit the type of material. Auto1 (normal): For viewing film material Auto2: For viewing film material (the same as Auto1, but able to convert 30-frame-per-second progressive video) Video: For video material

Audio Menu

Dolby Pro Logic II	(→ page 24)
Dialogue Enhancer	To make the dialogue in movies easier to hear DVD-V (Dolby Digital, DTS, MPEG, 3-channel or over, with the dialogue recorded in the center channel) On ↔ Off
Multi Re-master	RAM DVD-V (Discs recorded with 48 kHz only) DVD-A (Discs recorded with 44.1 kHz and 48 kHz only) VCD CD <ul style="list-style-type: none"> • During 2ch output of these discs, this feature gives you a more natural sound by adding the higher frequency signals not recorded on the disc, for example, playing DVD-Video recorded with 48 kHz at 96 kHz. (Sampling frequency → page 34) • During multi-channel output of these discs, this feature reproduces the frequencies lost during recording to give you a sound closer to the original.
	WMA MP3 (Disc recording is other than 8 kHz, 16 kHz, 32 kHz) This feature reproduces the higher frequencies lost during recording to give you a sound closer to the original. 1 → 2 → 3 → Off ↑ DVD-A DVD-V CD (LPCM/PPCM) 1 High tempo (e.g., pop and rock) 2 Various tempos (e.g., jazz) 3 Low tempo (e.g., classical) Other discs 1 Light effect 2 Medium effect 3 Strong effect

Display Menu

Information	On ↔ Off (JPEG: Off, Date, Details)
Subtitle Position	0 to -60 (in 2 unit steps)
Subtitle Brightness	Auto , 0 to -7
4:3 Aspect	To select how to show images made for 4:3 aspect screens on a 16:9 aspect television Normal: Horizontally stretches images. Auto: Expands 4:3 letterbox images to fill more of the screen. Other images appear in full in the center of the screen. Shrink: Images appear in the center of the screen. Zoom: Expands all images to fill the screen. If your television has a similar feature, use it instead for a better effect.
Just Fit Zoom	To select the appropriate screen size to fit your TV screen
Manual Zoom	To zoom in and out manually
Bitrate Display	RAM DVD-V VCD DVD-A (Motion picture part) On ↔ Off
GUI See-through	On ↔ Off
GUI Brightness	-3 to +3

Other Menu

Play as DVD-Video or Play as DVD-Audio	While stopped <ul style="list-style-type: none"> • Select "Play as DVD-Video" to play DVD-Video contents of DVD-Audio.
Play as DVD-VR, Play as HighMAT or Play as Data Disc	While stopped <ul style="list-style-type: none"> • Select "Play as Data Disc" to play JPEG files on DVD-RAM or to play a HighMAT disc without using the HighMAT function.

Signal type/data



LPCM/PPCM/**DD**Digital/DTS/MPEG: Signal type
 kHz (Sampling frequency)/bit/ch (Number of channels)

Example: 3/2_1ch

.1:	Low frequency effect (not displayed if there is no signal)
0:	No surround
1:	Mono surround
2:	Stereo surround (left/right)
1:	Center
2:	Front left+Front right
3:	Front left+Front right+Center

Changing the player settings

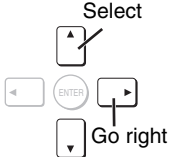
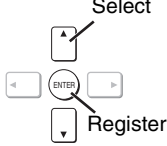
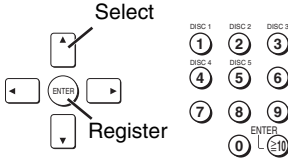
(Refer to page 9 for remote control button positions.)

1  Shows Setup menu.	2  Select the tab.	3  Select the item.	4  Make the settings.	5  Press to exit.
--	--	---	--	---

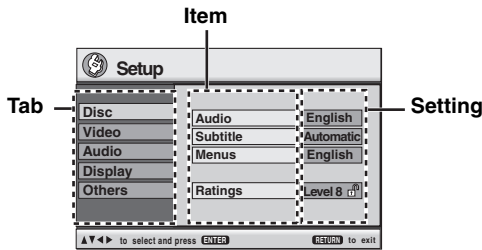

- The settings remain intact even if you switch the unit to standby.
- Underlined items are the factory preset.

The QUICK SETUP enables successive settings of the items in the shaded area.

■ “Disc” tab

Audio Choose the audio language.	• <u>English</u> • (Language options) ^{*1} • Original ^{*2} • Other***** ^{*3}
Subtitle Choose the subtitle language.	• <u>Automatic</u> ^{*4} • English • (Language options) ^{*1} • Other***** ^{*3}
Menus Choose the language for disc menus.	• <u>English</u> • (Language options) ^{*1} • Other***** ^{*3} • Changing the menu language from QUICK SETUP also changes this setting.
Ratings Set a ratings level to limit DVD-Video play. • Follow the on-screen instructions.	Setting ratings (When level 8 is selected) • <u>8 No Limit</u> • 1 to 7 • 0 Lock All: To prevent play of discs without ratings levels. Changing ratings (When level 0–7 is selected) • <u>Unlock Player</u> • Change Password • Change Level • Temporary Unlock

^{*1} Language options

Latin America: French, Spanish and Portuguese

Others: French and Spanish

^{*2} The original language designed on the disc is selected.

^{*3} Input a code number referring to the table on page 34.

^{*4} If the language selected for “Audio” is not available, subtitle appears in that language (If available on the disc).

■ “Video” tab

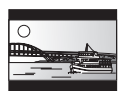
TV Aspect Choose the setting to suit your television and preference.	• 4:3 Pan&Scan: Regular aspect television (4:3) The sides of the widescreen picture are cut off so it fills the screen (unless prohibited by the disc). 
	• 4:3 Letterbox: Regular aspect television (4:3) Widescreen picture is shown in the letterbox style. 
	• 16:9: Widescreen television (16:9)
TV Type Select to suit the type of television.	• <u>Standard (Direct View TV)</u> • CRT Projector • LCD TV/Projector • Projection TV • Plasma TV
Time Delay When connected with a Plasma display, adjust if you notice the audio is out of sync with the video.	• <u>0ms</u> • 20ms • 40ms • 60ms • 80ms • 100ms
Still Mode Specify the type of picture shown when paused.	• <u>Automatic</u> • Field: The picture is not blurred, but picture quality is lower. • Frame: Overall quality is high, but the picture may appear blurred.
Black Level Control Change the black level of the picture if you connected a television through the COMPONENT VIDEO OUT terminals.	• <u>Lighter:</u> When connected through VIDEO OUT or S VIDEO OUT • Darker: When connected through COMPONENT VIDEO OUT (Y/P _B /P _R)

■ “Audio” tab

Dynamic Range Compression	<ul style="list-style-type: none"> ● Off ● On: Adjust for clarity even when the volume is low through compressing the range of the lowest sound level and the highest sound level. Convenient for late night viewing. (Only works with Dolby Digital)
Audio during Search	<ul style="list-style-type: none"> ● On ● Off
Speaker Setting (→ below) Set the delay time for your center and surround speakers.	<ul style="list-style-type: none"> ● Center: 0.0/1.0/2.0/3.0/4.0/5.0 ms ● Surround (L/R): 0.0/5.0/10.0/15.0 ms

■ “Display” tab

Menu Language	*5 ● English ● Français ● Español ● Português *6 ● English ● Français ● Español
On-Screen Messages	<ul style="list-style-type: none"> ● On ● Off

*5 Latin America

*6 Others

■ “Others” tab

FL Dimmer	<ul style="list-style-type: none"> ● Bright ● Dim ● Auto: The display is dimmed during play, but brightens when you perform some operations.
HighMAT	<ul style="list-style-type: none"> ● Enable ● Disable (Unable to use the HighMAT function.)
QUICK SETUP	<ul style="list-style-type: none"> ● Yes ● No
Re-initialize Setting This returns all values in the Setup menus to the default settings.	<ul style="list-style-type: none"> ● Yes: The password screen is shown if Ratings (→page 20) are set. Please enter the same password. After “INIT” on the display disappears, turn the unit off and on again. ● No

Changing the delay time (Speaker Setting)

(Effective when playing multi-channel audio)

(Center and surround speakers only)

For optimum listening with 5.1-channel sound, all the speakers, except for the subwoofer, should be the same distance from the seating position. If you have to place the center or surround speakers closer to the seating position, adjust the delay time to make up for the difference.

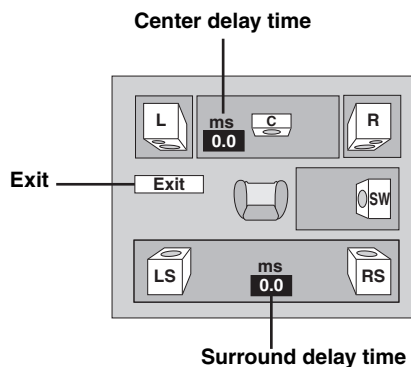

- 1 Press [▲ ▼] to select the delay time box and press [ENTER].
- 2 Press [▲ ▼] to adjust the delay time and press [ENTER].

If either distance (a) or (b) is less than (c), find the difference in the relevant table and change to the recommended setting.

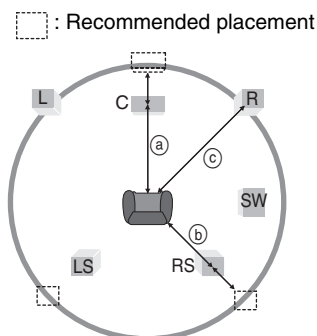

Ⓐ Center speaker

Difference	Setting
Approx. 34 cm (1 ¹ / ₁₀ feet)	1.0 ms
Approx. 68 cm (2 ¹ / ₅ feet)	2.0 ms
Approx. 102 cm (3 ³ / ₁₀ feet)	3.0 ms
Approx. 136 cm (4 ² / ₅ feet)	4.0 ms
Approx. 170 cm (5 ¹ / ₂ feet)	5.0 ms

Ⓑ Surround speaker

Difference	Setting
Approx. 170 cm (5 ¹ / ₂ feet)	5.0 ms
Approx. 340 cm (11 feet)	10.0 ms
Approx. 510 cm (16 ¹ / ₂ feet)	15.0 ms

To finish the speaker setting

Press [◀] to select “Exit” and press [ENTER].

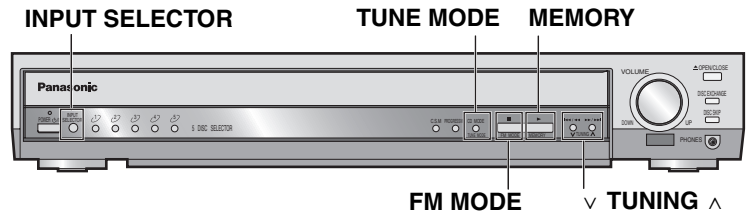
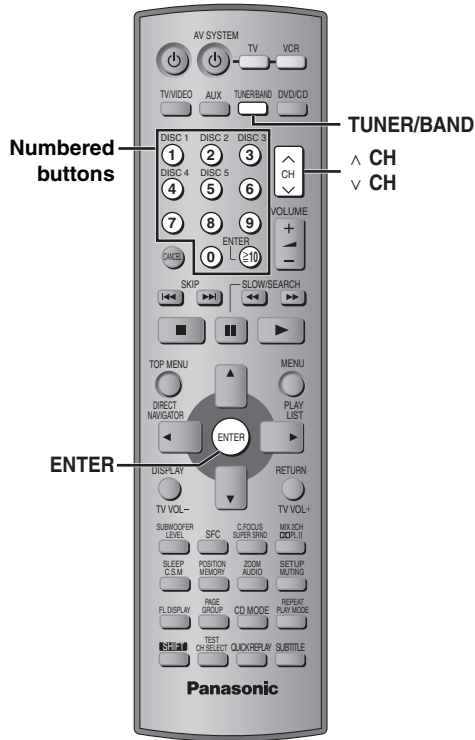

Automatic presetting

Up to 15 stations can each be set in the FM and AM bands.
Main unit only

- 1** Press [INPUT SELECTOR] to select “FM” or “AM”.
- 2** Press [TUNE MODE] to select “MANUAL”.
Each time you press the button: MANUAL ↔ PRESET
- 3** Press [v TUNING] or [TUNING ^] to tune to the lowest frequency (FM: 87.9 or 87.5, AM: 520).
Latin America: (FM: 87.50, AM: 522 or 520)
- 4** Press and hold [MEMORY].
Release the button when “FM AUTO” or “AM AUTO” is displayed.
The tuner presets all the stations it can receive into the channels in ascending order.
 • “SET OK” is displayed when the stations are set. The last station to be set is then played.

Selecting the preset channels

- 1** Press [TUNER/BAND] to select “FM” or “AM”.
- 2** Press the numbered buttons to select the channel.
Alternatively, press [v CH] or [^ CH].
To select a 2-digit number
e.g. 12: [≧10] → [1] → [2]



When a stereo FM broadcast is being received.



- If noise is excessive in FM
Main unit only
 Press [FM MODE] to display “MONO”.



Press [FM MODE] again to cancel the mode.
 The mode is also canceled when you change the frequency.

Manual tuning

Main unit only

- 1 Press [INPUT SELECTOR] to select "FM" or "AM".
- 2 Press [TUNE MODE] to select "MANUAL".
- 3 Press [v TUNING] or [TUNING ^] to select the frequency.

Press and hold [v TUNING] or [TUNING ^] until the frequency starts scrolling to start automatic tuning. Tuning stops when a station is found.

Presetting the channel one by one

- 1 Tune to the station (→ above).
- 2 Press [ENTER].
- 3 While "PGM" is flashing on the display Press the numbered buttons to select a channel.

Alternatively, press [v CH] or [^ CH], then press [ENTER].



The station occupying a channel is erased if another station is preset to that channel.

Allocation settings

Main unit only

Each country allocates broadcast bands according to their particular system.

For U.S.A., Canada, and units with PX printed on the outer packaging

You can change the FM step. The step is factory-set to 0.2 MHz, but you can change it to receive broadcasts allocated in 0.1-MHz steps.

For Latin America

You can change the AM step. The step is factory-set to 9 kHz, but you can change it to receive broadcasts allocated 10-kHz steps.

- 1 Press [INPUT SELECTOR] to select "FM" (for either band).
- 2 Press and hold [INPUT SELECTOR].
After a few seconds the display changes to show the current minimum frequency. Continue to hold the button down. The minimum frequency changes and the step is changed. To return to the original step, repeat the above steps.

Note

Any FM/AM frequencies preset in channels will be changed by this procedure. Preset them again.

Optional antenna connections

Use outdoor antennas if radio reception is poor.

- Disconnect the antenna when the unit is not in use.
- Do not use the outdoor antenna during an electrical storm.

FM outdoor antenna (Using a television antenna)

- Disconnect the FM indoor antenna.
- The antenna should be installed by a competent technician.

Rework your outdoor antenna's 75 Ω coaxial cable as follows (Except **Latin America**).

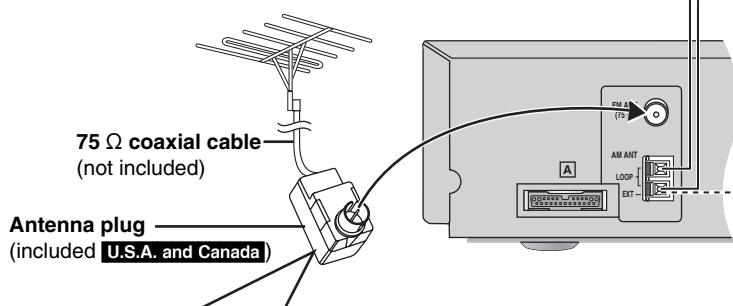

Leave the loop antenna connected.

AM outdoor antenna (Using a vinyl wire)

Run a piece of vinyl wire horizontally across a window or other convenient location.

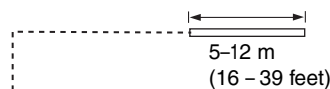

(Except **Latin America**)

- ① Remove a piece of the outer vinyl insulator.

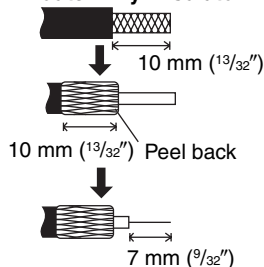

- ② Carefully pull the tabs apart to remove the cover.

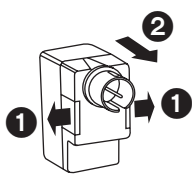

- ③ Install the coaxial cable. Clamp the cable conductor, and wind it on so that it does not contact anything else.

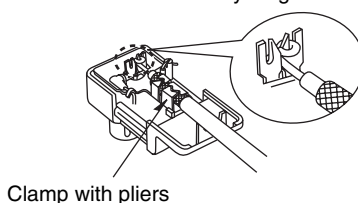

- ④ Attach the cover.

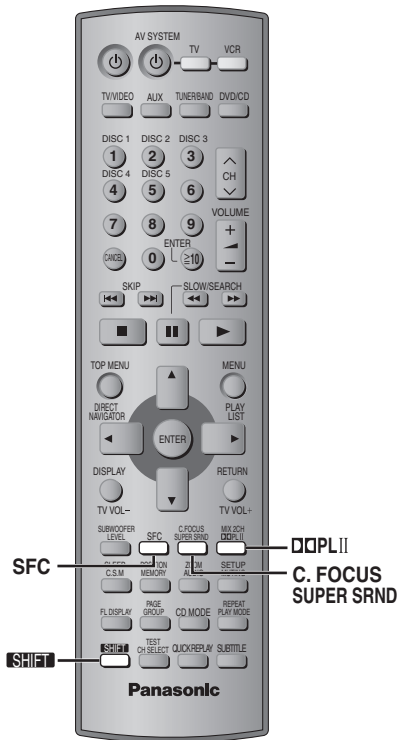

Sound Field Control

Changes the sound quality.



Super Surround

Adds surround effects to stereo sound.



Center Focus

For clearer dialogues.



Dolby Pro Logic II

Changes stereo sound to surround sound.

Note

- When connected with headphones, the following sound field systems cannot be used. (Excluding Sound Field Control)
- You may experience a reduction in sound quality when these sound field systems are used with some sources. If this occurs, turn the sound field system off.

See below for details.



Sound Field Control

Press [SFC].

Each time you press the button:

- HEAVY:** Adds punch to rock.
- CLEAR:** Clarifies higher sounds.
- SOFT:** For background music.
- DISCO:** Reverberates sound to make you feel like you are in a disco.
- LIVE:** Makes vocals more alive.
- HALL:** Expands sound to make you feel like you are in a hall.
- FLAT:** Cancel (no effect is added) (factory preset).



To check the current setting

Press [SFC].

Super Surround

Press [SUPER SRND].

Each time you press the button:

- MUSIC:** Adds surround effects to stereo sources.
- MOVIE:** Use this mode when playing movie software.
- PARTY:** Sound is in stereo regardless of the direction you are facing. (off): Cancel



- You can adjust the volume of the surround speakers to get the best surround effect (→ page 25, Speaker level adjustments).
- Super Surround does not work when playing a DVD recorded with Dolby Digital or DTS.
- When Super Surround is on, Dolby Pro Logic II (→ right) turns off.

Center Focus

(Discs where the dialogue is recorded in the center channel)

You can make the sound of the center speaker seem like it is coming from within the television.

Press [SHIFT]+[C. FOCUS].



CENTER FOCUS ON ← → CENTER FOCUS OFF

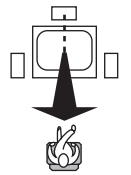

- This does not work when Super Surround is turned on.
- This will also work when Dolby Pro Logic II is turned on.

Dolby Pro Logic II

Dolby Pro Logic II is an advanced decoder that derives 5-channel surround (Left and Right Front, Center, Left and Right Surround) from any stereo program material, whether or not it has been specifically Dolby Surround encoded.

Press [DOLBY II].

Each time you press the button:
MOVIE: Movie software, recorded in Dolby Surround.

MUSIC: Stereo sources.

OFF: Cancel



- This works only in DVD/CD mode.
- "DOLBY II" lights when there is effect.

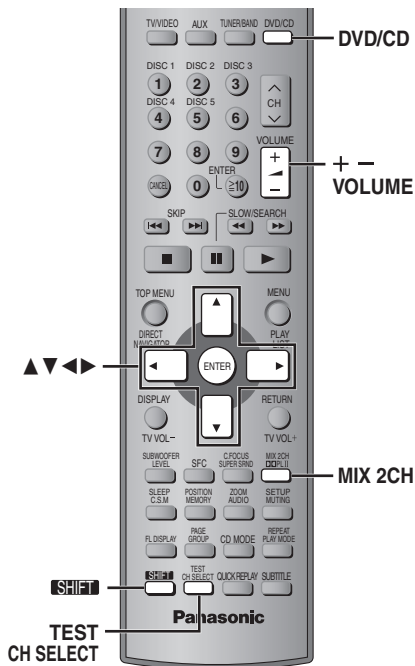

Down-mixing

Down-mixes multi-channel signals to 2 channels.



Speaker level adjustments

See below for details.



Down-mixing

You can output the down-mixed 2 channel signals when necessary (e.g. when you intend to record 5.1 ch sound on other recording equipment).

Press **[SHIFT]**+**[MIX 2CH]**.

MIX 2CH

MIX 2CH ON ← → MIX 2CH OFF

Note

When "D.MIX" flashes on the display, the disc contains multiple-channel signals that cannot be down-mixed. **DVD-A**

Speaker level adjustments

This is one of the ways to get appropriate surround effects. Adjust the speaker level to the same level as the front speakers.

Preparation

Press **[DVD/CD]**.

1

While stopped

Press **[SHIFT]**+**[TEST]** to output a test signal.

L: Front left C: Center R: Front right
RS: Right surround LS: Left surround

2

Press **[VOLUME, +]** or **[-]** to set the volume level normally used for listening.

3

Press **[▲]** (increase) or **[▼]** (decrease) to adjust the speaker level for each speaker.

C, RS, LS: -6 dB to +6 dB (L, R: Only the balance is adjustable.)

•To adjust the balance of the front speakers

While outputting the test signal, press **[◀ ▶]**.

To stop the test signal

Press **[SHIFT]**+**[TEST]** again.

Note

There is no output from SW (subwoofer) channel.

■ To adjust speaker level during play

(Effective when playing multi-channel audio or Dolby Pro Logic II is on.)

1

Press **[CH SELECT]** to select the speaker.

L → C → R → RS → LS → SW

↑

SW: Subwoofer

•You can adjust SW only if the disc includes a subwoofer channel.

•SW does not appear on the display and is not adjustable when Dolby Pro Logic II is turned on.

•S appears instead of RS and LS on the display when "MUSIC" or "MOVIE" is selected with Super Surround (→page 24). In this case, you can adjust both surround speaker levels at the same time.

S: -6 dB to +6 dB

2

Press **[▲]** (increase) or **[▼]** (decrease) to adjust the speaker level for each speaker.

C, RS, LS, SW: -6 dB to +6 dB

(L, R: Only the balance is adjustable.)

•To adjust the balance of the front speakers

During play, press **[◀ ▶]**.



Subwoofer level

Adjusts the amount of bass.



Custom Sound Memory

Stores up to 30 sound settings (one setting per disc).

See below for details.



Subwoofer level

Press [SUBWOOFER LEVEL].

SUB W 1 → SUB W 2 → SUB W 3 → SUB W 4 (factory preset)



Custom Sound Memory

DVD-A DVD-V VCD CD

Available sound setting:

Subwoofer level, Center Focus, Sound Field Control, Super Surround

After making the sound field or sound quality settings

Press and hold [C.S.M.].



Recall the settings

The unit recalls the settings when you play the disc again.

- The settings are replaced if you change them.
- When you store settings for the 31st disc, the settings for the earliest disc are cleared.
- Press [C.S.M] while "CSM" is displayed to cancel the sound setting for the disc.
- Press [C.S.M] while "CSM" is out to recall the sound setting for the disc.



Sleep timer
Turns the unit off after a set time.



Muting

See below for details.



Sleep timer

Press **[SHIFT]**+**[SLEEP]** to select the time (in minutes).



SLEEP 30 → SLEEP 60 → SLEEP 90
↑ OFF ← SLEEP 120 ←

To cancel the timer

Press **[SHIFT]**+**[SLEEP]** to select "OFF".

To confirm the remaining time

Press **[SHIFT]**+**[SLEEP]** again.

To change the setting

Repeat the procedure from the beginning.

Muting

Press **[MUTING]**.

"MUTING" flashes on the unit's display.



To cancel

- Press **[MUTING]** again or reduce the volume to minimum (— dB), then raise it to the required level.
- Muting is canceled when you switch the unit to standby.

Using headphones

1 Reduce the volume and connect the headphones (not included).

Headphone plug type: 3.5 mm (1/8") stereo



2 Adjust headphone volume with **[VOLUME]**.

- Audio is automatically switched to stereo (2-channel).

Note

Avoid listening for prolonged periods of time to prevent hearing damage.

Operating other equipment

■ Connection example

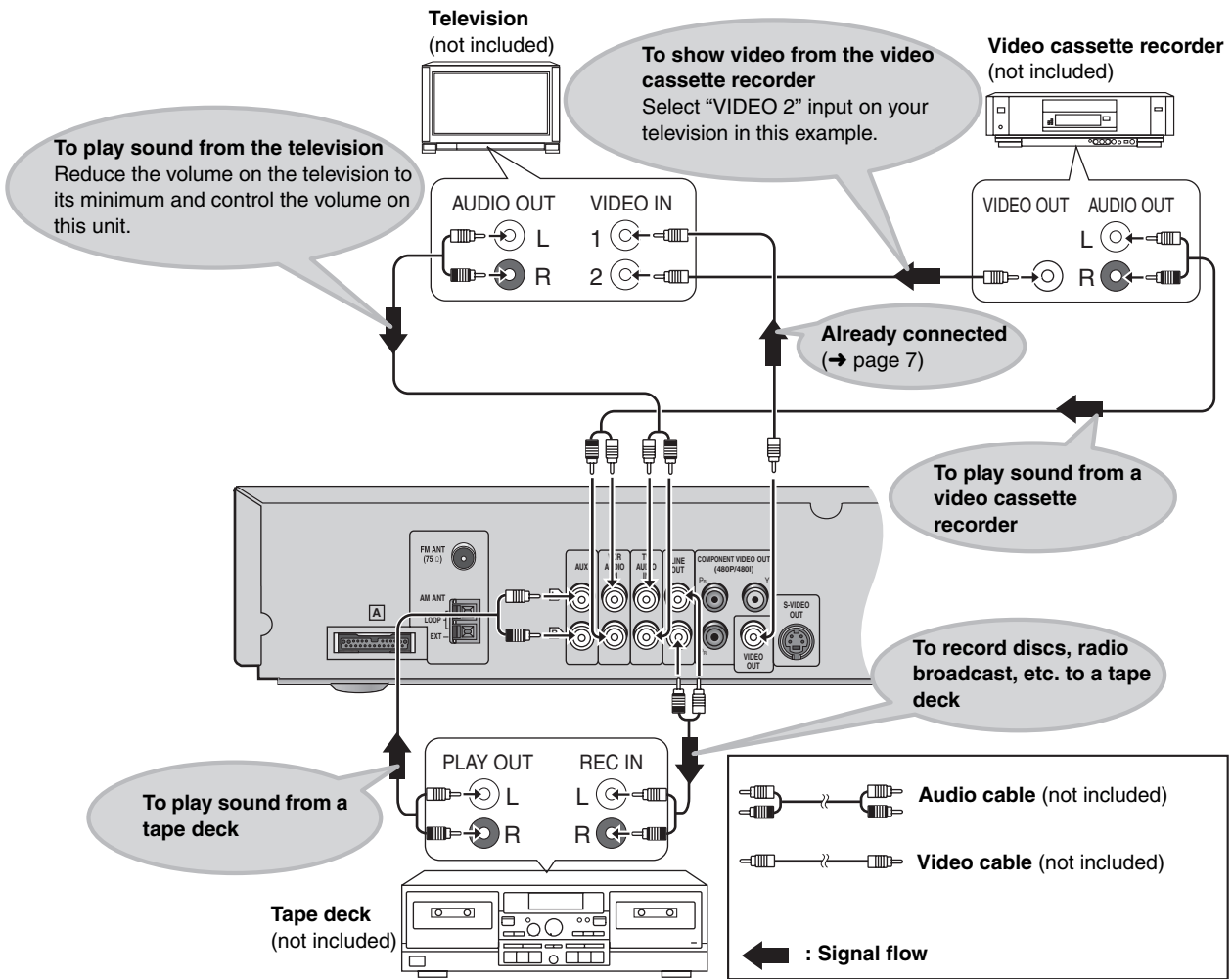

Operating other equipment

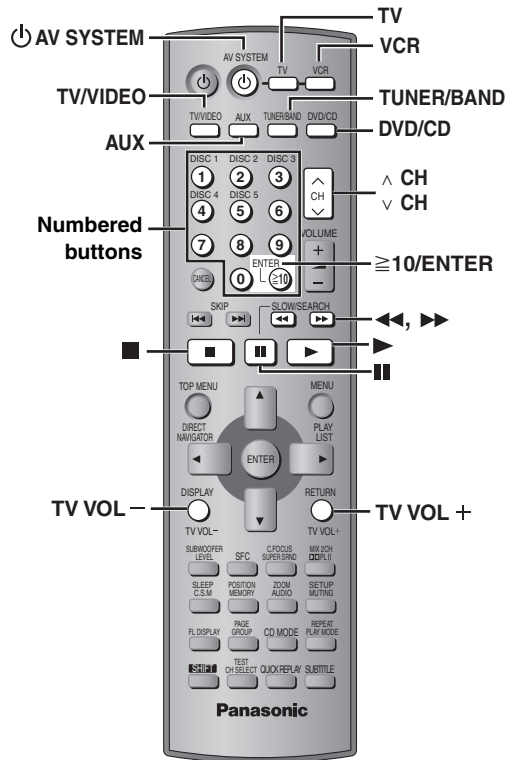

Operating the television and the video cassette recorder

You can use the remote control to operate a Panasonic television or a video cassette recorder. Connect your equipment referring to "Connection example" (→ page 28).

Note

The remote control may not work properly with some models.

Television

Preparation

- Face the remote control at the unit and press [TV] to light up the button.
- Face the remote control at the television for the following operations.

Turning the television on/off

Press [⏻ AV SYSTEM].

Switching the television's video input mode

Press [TV/VIDEO].

Changing channels

Press [∇ CH] or [∧ CH].

- [≥10/ENTER] is used to confirm channel selection on some televisions manufactured by other companies.

Adjusting the volume

Press [TV VOL-] or [TV VOL+].

Video cassette recorder

Preparation

- Change the video input mode on the television ("VIDEO 2" in the example).
- Face the remote control at the unit and press [VCR] to light up the button.
- Face the remote control at the video cassette recorder for the following operations.

Turning the video cassette recorder on/off

Press [⏻ AV SYSTEM].

Play, pause and stop

Press [▶] (play), [⏸] or [■].

Fast forward and rewind

Press [⏪] or [⏩].

Connecting a laser disc or record player

Connect instead of a video cassette recorder (→ page 28) and select "VCR" as the source.

- We recommend using a record player with a built-in phono equalizer. If your player doesn't have a built-in equalizer, connect it first to a separate equalizer and then to the unit.

Changing the remote control code

This remote control can also operate some other brands of televisions, video cassette recorders. Change the code to operate such equipment (→ below).

Face the remote control at the equipment.

While pressing [TV] or [VCR]

Press a numbered button to enter the first digit, and then the second digit.

The remote control outputs the on/off signal. If the code is correct, the equipment turns on or off. If it doesn't, try entering another code.

Note

Reenter the codes after you change the batteries.

Operating the tape deck

Listening to the tape deck

Press [AUX] to select "AUX" as the source.

Recording to the tape deck

- 1 Press [DVD/CD] to select "DVD/CD".
or
Press [TUNER/BAND] to select "FM" or "AM".
- 2 Start recording and play.

Television code list

Panasonic:	01, 02, 26	Philco:	06, 07
Sony:	04	Philips:	06
Fisher:	14	Pioneer:	02, 10, 19
G-E:	02, 03, 07, 09	Quasar:	02
Gold Star:	07, 15	RCA:	03, 07, 09, 13, 23, 24, 25
Hitachi:	05, 07	Sanyo:	14
JVC:	12	Sharp:	08, 21
LXI:	03, 06, 07, 10, 14, 15	Sylvania:	06, 07, 15
Magnavox:	06, 07, 11, 15, 22	Symphonic:	17
Mitsubishi:	07, 15, 16, 21	Toshiba:	10, 21
NEC:	07, 15	Zenith:	18, 20

Video cassette recorder code list

Panasonic:	01, 02, 09, 33	NEC:	19, 25, 31, 38
Sony:	05, 06, 07, 35, 36, 37	Philco:	02, 09, 12, 30
Fisher:	13, 14, 15, 18, 34	Philips:	02, 09, 12
Funai:	08, 30	Pioneer:	09
G-E:	02, 03, 11	Quasar:	01, 02, 09, 33
Gold Star:	27	RCA:	02, 03, 04, 09, 10, 11, 12, 23, 24, 26
Hitachi:	09, 10, 11	Sanyo:	14, 18, 34
JVC:	19, 25, 31, 38, 39, 40	Sharp:	16, 17
LXI:	10, 13, 14, 15, 18, 27, 30	Shintom:	32
Magnavox:	02, 09, 12	Sylvania:	02, 09, 12, 30
Mitsubishi:	21, 22, 28, 29	Symphonic:	30
		Toshiba:	23, 24
		Zenith:	20

AMPLIFIER SECTION

HT720

RMS Output Power: Dolby Digital Mode

Front Ch	70 W per channel (4 Ω), 1 kHz, 10 % THD
Surround Ch	70 W per channel (4 Ω), 1 kHz, 10 % THD
Center Ch	260 W per channel (4 Ω), 1 kHz, 10 % THD
Subwoofer Ch	260 W per channel (4 Ω), 100 Hz, 10 % THD
Total RMS Dolby Digital mode power	800 W

Latin America PMPO Output Power

6500 W

U.S.A., Canada and units with PX printed on the outer packaging:

FTC Output Power: Dolby Digital Mode

Front Ch	45 W per channel (4 Ω), 120 Hz–20 kHz, 1 % THD
Surround Ch	45 W per channel (4 Ω), 120 Hz–20 kHz, 1 % THD
Center Ch	140 W per channel (4 Ω), 120 Hz–20 kHz, 1 % THD
Subwoofer Ch	150 W per channel (4 Ω), 45 Hz–120 Hz, 1 % THD
Total FTC Dolby Digital mode power	470 W

HT692

RMS Output Power: Dolby Digital Mode

Front Ch	65 W per channel (4 Ω), 1 kHz, 10 % THD
Surround Ch	60 W per channel (4 Ω), 1 kHz, 10 % THD
Center Ch	250 W per channel (4 Ω), 1 kHz, 10 % THD
Subwoofer Ch	250 W per channel (4 Ω), 100 Hz, 10 % THD
Total RMS Dolby Digital mode power	750 W

FTC Output Power: Dolby Digital Mode

Front Ch	40 W per channel (4 Ω), 120 Hz–20 kHz, 1 % THD
Surround Ch	40 W per channel (4 Ω), 120 Hz–20 kHz, 1 % THD
Center Ch	130 W per channel (4 Ω), 120 Hz–20 kHz, 1 % THD
Subwoofer Ch	140 W per channel (4 Ω), 45 Hz–120 Hz, 1 % THD
Total FTC Dolby Digital mode power	430 W

FM/AM TUNER, TERMINALS SECTION

Preset station	FM 15 stations AM/MW 15 stations
----------------	-------------------------------------

Frequency Modulation (FM)

U.S.A., Canada and units with PX printed on the outer packaging:

87.9–107.9 MHz (200-kHz step)
87.5–108.0 MHz (100-kHz step)

Latin America

87.50–108.00 MHz (50-kHz step)

Sensitivity	2.5 μV (IHF)
S/N 26 dB	2.2 μV
Antenna terminals	75 Ω (unbalance)

Amplitude Modulation (AM/MW)

U.S.A., Canada, and units with PX printed on the outer packaging:

Frequency range	520–1710 kHz (10-kHz step)
AM Sensitivity S/N 20 dB at 1000 kHz	560 μV/m

Latin America:

Frequency range	522–1629 kHz (9-kHz step) 520–1630 kHz (10-kHz step)
AM Sensitivity S/N 20 dB at 999 kHz	560 μV/m

Phone jack

Terminal	Stereo, 3.5 mm (1/8") jack
----------	----------------------------

DISC SECTION

Discs played [8 cm (3") or 12 cm (5")]

- DVD-RAM (DVD-VR compatible, JPEG formatted discs)
- DVD-Audio
- DVD-Video
- DVD-R (DVD-Video compatible)
- CD-Audio (CD-DA)
- Video CD
- SVCD (Conforming to IEC62107)
- CD-R/RW (CD-DA, Video-CD, SVCD, MP3, WMA, JPEG formatted disc)
- MP3/WMA*¹
 - Compatible compression rate:
 - MP3: between 32 kbps and 320 kbps
 - WMA: between 48 kbps and 320 kbps
- JPEG*¹
 - Exif Ver 2.1 JPEG Baseline files
 - Picture resolution: between 320×240 and 6144×4096 pixels (sub sampling is 4:2:2 or 4:2:0)
- HighMAT Level 2 (Audio and Image)

*¹The total combined maximum number of recognizable audio and picture contents and groups: 4000 audio and picture contents and 400 groups.

Pick up

Wavelength	CD 785 nm DVD 662 nm
------------	-------------------------

Laser power	U.S.A. CLASS IIa/CLASS I Others CLASS 2/CLASS 3A
-------------	---

Audio output (Disc)

Number of channels	5.1ch (FL, FR, C, SL, SR, SW)
--------------------	-------------------------------

Audio performance

(1) Frequency response

• DVD (linear audio)	4 Hz–22 kHz (48 kHz sampling) 4 Hz–44 kHz (96 kHz sampling)
• DVD-Audio	4 Hz–88 kHz (192 kHz sampling)
• CD-Audio	4 Hz–20 kHz

(2) S/N ratio

• CD-Audio	95 dB
------------	-------

(3) Dynamic range

• DVD (linear audio)	95 dB
• CD-Audio	93 dB

(4) Total harmonic distortion

• CD-Audio	0.005 %
------------	---------

VIDEO SECTION

Video system

Signal system	NTSC
---------------	------

Composite video output

Output level	1 Vp-p (75 Ω)
Terminal	Pin jack (1 system)

S-video output

Y output level	1 Vp-p (75 Ω)
C output level	NTSC; 0.286 Vp-p (75 Ω)
Terminal	S terminal (1 system)

Component video output (480P/480I)

Y output level	1 Vp-p (75 Ω)
P _B output level	0.7 Vp-p (75 Ω)
P _R output level	0.7 Vp-p (75 Ω)
Terminal	Pin jack (Y: green, P _B : blue, P _R : red) (1 system)

SUBWOOFER SECTION

HT720 Active subwoofer SB-WA720

HT692 Active subwoofer SB-WA692

Type	1 way, 1 speaker system (Bass reflex)
Speaker unit(s)	Impedance 4 Ω
Woofer	17 cm (6 ³ / ₄ " Cone type
Output sound pressure	80 dB/W (1.0 m)
Frequency range	32 Hz–220 Hz (–16 dB)
	36 Hz–190 Hz (–10 dB)
Dimensions (W×H×D)	209×361×463 mm
	(8 ⁷ / ₃₂ "×14 ⁷ / ₃₂ "×18 ⁷ / ₃₂ "

Mass

U.S.A. and Canada

11.7 kg (25.8 lb.)

Others

12.6 kg (27.8 lb.)

SPEAKER SECTION

Front speakers SB-FS720

Type	2 way, 2 speaker system (Bass reflex)
Speaker unit(s)	Impedance 4 Ω
1. Woofer	6.5 cm (2 ¹ / ₂ " Cone type
2. Tweeter	6 cm (2 ³ / ₈ " Ring shaped dome type
Input power (IEC)	70 W (Max)
Output sound pressure	80 dB/W (1.0 m)
Cross over frequency	6 kHz
Frequency range	96 Hz–50 kHz (–16 dB)
	105 Hz–45 kHz (–10 dB)
Dimensions (W×H×D)	86×240×114 mm
	(3 ³ / ₈ "×9 ⁷ / ₁₆ "×4 ¹ / ₂ "
Mass	0.9 kg (1.98 lb.)

Surround speakers SB-FS520

Type	1 way, 1 speaker system (Bass reflex)
Speaker unit(s)	Impedance 4 Ω
Full range	6.5 cm (2 ¹ / ₂ " Cone type
Input power (IEC)	70 W (Max)
Output sound pressure	80 dB/W (1.0 m)
Frequency range	88 Hz–25 kHz (–16 dB)
	100 Hz–22 kHz (–10 dB)
Dimensions (W×H×D)	86×180×112 mm
	(3 ³ / ₈ "×7 ³ / ₃₂ "×4 ¹³ / ₃₂ "
Mass	0.73 kg (1.6 lb.)

Center speaker SB-PC720

Type	2 way, 3 speaker system (Bass reflex)
Speaker unit(s)	Impedance 4 Ω
1. Full range	6.5 cm (2 ¹ / ₂ " Cone type
2. Full range	6.5 cm (2 ¹ / ₂ " Cone type
3. Super tweeter	Piezo type
Input power (IEC)	260 W* (Max)
Output sound pressure	82 dB/W (1.0 m)
Cross over frequency	10 kHz
Frequency range	88 Hz–25 kHz (–16 dB)
	98 Hz–22 kHz (–10 dB)
Dimensions (W×H×D)	300×102×116 mm
	(11 ¹³ / ₁₆ "×4 ¹ / ₃₂ "×4 ⁹ / ₁₆ "
Mass	1.37 kg (3 lb.)

GENERAL

Power supply

U.S.A. and Canada

AC 120 V, 60 Hz

Others

AC 110 V/127 V/220–230 V/240 V, 50/60 Hz

Power consumption

Main unit 25 W

Subwoofer 340 W

Dimensions (W×H×D)

430×68×432 mm

(16¹⁵/₁₆"×2¹¹/₁₆"×17")

Mass

Main unit 4.1 kg (9.0 lb.)

Operating temperature range

+5 to +35 °C (+41 to +95 °F)

Operating humidity range

5 to 90 % RH (no condensation)

Power consumption in standby mode

U.S.A. and Canada

0.4 W

Others

0.9 W

* Rating with low cut filter equipped amplifier

Note

1. Specifications are subject to change without notice. Mass and dimensions are approximate.
2. Total harmonic distortion is measured by the digital spectrum analyzer.

Before requesting service, make the following checks. If you are in doubt about some of the check points, or if the remedies indicated in the chart do not solve the problem, refer to the “Customer Services Directory” on page 35 if you reside in the U.S.A., or refer to the “Product Information on page 34 if you reside in Canada.
In other areas, consult your dealer.

Power		Page
No power.	● Insert the AC power supply cord and system cable securely.	8
The unit is automatically switched to the standby mode.	● The Sleep timer activated.	27

Unresponsive or inoperable function

No response when any buttons pressed.	● This unit cannot play discs other than the ones listed in these operating instructions.	10
	● The unit may not be operating properly due to lightning, static electricity or some other external factor. Turn the unit off and then back to ON. Alternatively, turn the unit off, disconnect the AC power supply cord, and then reconnect it.	—
	● Condensation has formed: Wait 1 to 2 hours for it to evaporate.	—
No response when remote control buttons pressed.	● Check that the batteries are installed correctly.	8
	● The batteries are depleted. Replace them with new ones.	8
	● Point the remote control at the remote control sensor and operate.	9
Cannot play DVDs.	● CD Mode is on. Press [CD MODE] to turn CD Mode off.	13
No picture or sound.	● Check the video or audio connection.	6-8, 28
	● Check the power or input setting of the connected equipment.	—
	● Check that the DVD-RAM has something recorded on it.	—
You have forgotten your ratings password. Reset all the settings to Factory Preset.	● While stopped and “DVD/CD” is the source, press and hold [■] on the main unit and [≥10] on the remote control until “Initialized” disappears from the television. Turn the unit off and on again. All settings will return to the default values.	—

Specific operation undesirable or unexpected

It takes time before play starts. [MP3]	● Play may take time to begin when an MP3 track has still picture data. Even after the track starts, the correct play time will not be displayed, however this is normal.	—
Folders deeper than the eighth layer on a data CD are not displayed correctly. [WMA] [MP3] [JPEG]	● Folders deeper than the eighth layer are displayed as the eighth layer.	—
A menu screen appears during skip or search. [VCD]	● This is normal for Video CDs.	—
Programmed items are not played. [DVD-V]	● Some items cannot be played even if you have programmed them.	—
The on-screen menu shows “2” as a soundtrack option when [AUDIO] is pressed, but the audio does not change. [DVD-A]	● Even if a second soundtrack isn’t recorded, two numbers will normally be shown.	—
Play restarts from the beginning of the track when soundtrack is changed. [DVD-A]	● This is normal on DVD-Audio.	—

Subtitle

Subtitle position is wrong.	● Adjust the position. (“Subtitle Position” in Display Menu)	19
No subtitles.	● Display the subtitles.	14
The subtitles overlap closed captions recorded on discs.	● Clear the subtitles.	14

Marker

Cannot add markers.	● You cannot add markers with DVD-RAM.	—
	● If the disc’s elapsed play time doesn’t appear on the unit’s display, you cannot add markers.	—

A-B repeat

Point B is automatically set.	● The end of an item becomes point B when it is reached.	—
A-B repeat is automatically canceled.	● A-B repeat is canceled when you press [QUICK REPLAY].	—

Sound abnormal or improper

Sound distorted.	● Noise may occur when playing WMA files.	—
Effects do not work.	● Some audio effects do not work or have less effect with some discs.	—
	● Multi Re-master and Dolby Pro Logic II do not work if you have changed the play speed.	—
Humming heard during play.	● An AC power supply cord or fluorescent light is near the subwoofer. Keep other appliances and cables away from the subwoofer.	—

Menus

Page

The Setup menu cannot be accessed.	<ul style="list-style-type: none"> ●Select "DVD/CD" as the source. ●Cancel all group, program and random play. 	— 15
------------------------------------	--	---------

Picture abnormal or un-viewable

Picture distorted.	<ul style="list-style-type: none"> ●Ensure that the unit is connected directly to the television, and is not connected through a video cassette recorder. 	7
Picture size doesn't fit the screen.	<ul style="list-style-type: none"> ●Change "TV Aspect" in "Video" tab. ●Use the television to change the aspect. If your television does not have that function, change "4:3 Aspect" in Display Menu. ●Change the Zoom setting. ●The images on PAL system DVD-Audio are compressed for display. They may also appear vertically stretched. 	20 19 14 —
Menu not displayed correctly.	<ul style="list-style-type: none"> ●Restore the zoom ratio to $\times 1.00$. ●Set "Subtitle Position" in Display Menu to "0". ●Set "4:3 Aspect" in Display Menu to "Normal". 	14 19 19
Auto zoom function does not work well.	<ul style="list-style-type: none"> ●Turn off TV's zoom function. ●Use the other preset aspect ratios or manual adjustment. ●Zoom function may not work well, especially in dark scenes and may not work depending on the type of disc. 	— 14 —
The picture on the television disappears or stripes appear on the screen.	<ul style="list-style-type: none"> ●Mobile telephone chargers can cause some disturbance. ●If you are using a TV indoor antenna, change to an outdoor antenna. ●The television antenna wire is too close to the unit. Separate the antenna wire of the television from the unit. 	— 23 —

Progressive video

There is ghosting when progressive output is on.	<ul style="list-style-type: none"> ●Change "Video Output Mode" in Picture Menu to "480I". This problem is caused by the editing method or material used on DVD-Video, but should be corrected if you use interlace output. 	19
Pictures not in progressive output.	<ul style="list-style-type: none"> ●Press [PROGRESSIVE] on the main unit so "PROG." is displayed. Or select "480P" in "Video Output Mode" in Picture Menu. ●If the unit is connected to the television through VIDEO OUT or S-VIDEO OUT output will be interlace. 	12, 19 7
Closed captions not displayed.	<ul style="list-style-type: none"> ●When progressive output is on, closed captions will not be displayed. 	—

Listening to the radio

Noise is heard. "ST" flickers or doesn't light. Sound is distorted.	<ul style="list-style-type: none"> ●Adjust the position of the FM or AM antenna. ●Use an outdoor antenna. 	— 23
A beat sound is heard.	<ul style="list-style-type: none"> ●Turn the television off or separate it from the unit. 	—
A low hum is heard during AM broadcasts.	<ul style="list-style-type: none"> ●Separate the antenna from other cables. 	—

Television operation

Cannot operate the TV.	<ul style="list-style-type: none"> ●Press [TV] first to operate the television. ●Check the remote control code for the TV manufacturer. 	— 29
------------------------	---	---------

Unit displays

The display is dark.	<ul style="list-style-type: none"> ●Select "Bright" in "FL Dimmer" in "Others" tab. 	21
"NO PLAY"	<ul style="list-style-type: none"> ●You inserted a disc the unit cannot play; insert one it can. ●You inserted a blank disc. 	10 —
"NO DISC"	<ul style="list-style-type: none"> ●You haven't inserted a disc; insert one. ●You haven't inserted the disc correctly; insert it correctly. 	— 12
"F61"	<ul style="list-style-type: none"> ●Check and correct the speaker cord connections. ●If this does not fix the problem, there is a power supply problem. Consult the dealer. 	6
"DVD U11"	<ul style="list-style-type: none"> ●Disc is dirty. Wipe it clean. 	11
"ERROR"	<ul style="list-style-type: none"> ●Incorrect operation performed. Read the instructions and try again. 	—
"DVD H□□" □□ stands for a number.	<ul style="list-style-type: none"> ●Trouble may have occurred. The number following "H" depends on the status of the unit. Turn the unit off and then back to ON. Alternatively, turn the unit off, disconnect the AC power supply cord, and then reconnect it. ●If the service numbers fail to clear, note the service number and contact a qualified service person. 	— —

Television displays

"⊘"	<ul style="list-style-type: none"> ●The operation is prohibited by the unit or disc. 	—
"Cannot display group xx, content xx"	<ul style="list-style-type: none"> ●You are trying to display incompatible contents. 	17
"This disc may not be played in your region"	<ul style="list-style-type: none"> ●You can only play DVD-Video if their region number is the same or includes the same region number as the unit or if the DVD-Video is marked "ALL". Confirm the region number for the unit on the rear panel. 	Cover
No on-screen display.	<ul style="list-style-type: none"> ●Select "On" in "On-Screen Messages" in "Display" tab. 	21

- 1. Damage requiring service**—The unit should be serviced by qualified service personnel if:
 - (a) The AC power supply cord or AC adaptor has been damaged; or
 - (b) Objects or liquids have gotten into the unit; or
 - (c) The unit has been exposed to rain; or
 - (d) The unit does not operate normally or exhibits a marked change in performance; or
 - (e) The unit has been dropped or the cabinet damaged.
- 2. Servicing**—Do not attempt to service the unit beyond that described in these operating instructions. Refer all other servicing to authorized servicing personnel.
- 3. Replacement parts**—When parts need replacing ensure the servicer uses parts specified by the manufacturer or parts that have the same characteristics as the original parts. Unauthorized substitutes may result in fire, electric shock, or other hazards.
- 4. Safety check**—After repairs or service, ask the servicer to perform safety checks to confirm that the unit is in proper working condition.

The servicer will require all components to service your system. Therefore, should service ever be necessary, be sure to bring the entire system.

Product information

For product information or assistance with product operation:

In the U.S.A., refer to "Customer Services Directory" on page 35. In Canada, contact the Panasonic Canada Inc. Customer Care Centre at 1-800-561-5505, or visit the website (www.panasonic.ca), or an authorized Servicentre closest to you. In other areas, consult your dealer.

Maintenance

Clean this unit with a soft, dry cloth.

- Never use alcohol, paint thinner or benzine to clean this unit.
- Before using chemically treated cloth, read the instructions that came with the cloth carefully.

Before moving the unit, ensure the disc trays are empty. Failure to do so will risk severely damaging the discs and the unit.

Decoder

A decoder restores the coded audio signals on DVDs to normal. This is called decoding.

Dolby Digital

This is a method of coding digital signals developed by Dolby Laboratories. Apart from stereo (2-channel) audio, these signals can also be multi-channel audio. A large amount of audio information can be recorded on one disc using this method.

DTS (Digital Theater Systems)

This surround system is used in many movie theaters around the world. There is good separation between the channels, so realistic sound effects are possible.

Dynamic range

Dynamic range is the difference between the lowest level of sound that can be heard above the noise of the equipment and the highest level of sound before distortion occurs.

Frame still and field still

Frames are the still pictures that go together to make a moving picture. There are about 30 frames shown each second. One frame is made up of two fields. A regular television shows these fields one after the other to create frames. A still is shown when you pause a moving picture. A frame still is made up of two alternating fields, so the picture may appear blurred, but overall quality is high. A field still is not blurred, but it has only half the information of a frame still so picture quality is lower.

I/P/B

MPEG 2, the video compression standard adopted for use with DVD-Video, codes frames using these 3 picture types.

- I:** Intra coded picture
This picture has the best quality and is the best to use when adjusting the picture.
- P:** Predictive coded picture
This picture is calculated based on past I or P-pictures.
- B:** Bidirectionally-predictive coded picture
This picture is calculated by comparing past and future I and P-pictures so it has the lowest volume of information.

Linear PCM (pulse code modulation)

These are uncompressed digital signals, similar to those found on CDs.

Playback control (PBC)

If a Video CD has playback control, you can select scenes and information with menus.

Sampling frequency

Sampling is the process of converting the heights of sound wave (analog signal) samples taken at set periods into digits (digital encoding). Sampling frequency is the number of samples taken per second, so larger numbers mean more faithful reproduction of the original sound.

Language code list

Abkhazian: 6566	Chinese: 9072	Hausa: 7265	Lithuanian: 7684	Romanian: 8279	Telugu: 8469
Afar: 6565	Corsican: 6779	Hebrew: 7387	Macedonian: 7775	Russian: 8285	Thai: 8472
Afrikaans: 6570	Croatian: 7282	Hindi: 7273	Malagasy: 7771	Samoan: 8377	Tibetan: 6679
Albanian: 8381	Czech: 6783	Hungarian: 7285	Malay: 7783	Sanskrit: 8365	Tigrinya: 8473
Ameharic: 6577	Danish: 6865	Icelandic: 7383	Malayalam: 7776	Scots Gaelic: 7168	Tonga: 8479
Arabic: 6582	Dutch: 7876	Indonesian: 7378	Maltese: 7784	Serbian: 8382	Turkish: 8482
Armenian: 7289	English: 6978	Interlingua: 7365	Maori: 7773	Serbo-Croatian: 8372	Turkmen: 8475
Assamese: 6583	Esperanto: 6979	Irish: 7165	Marathi: 7782	Shona: 8378	Twi: 8487
Aymara: 6588	Estonian: 6984	Italian: 7384	Moldavian: 7779	Sindhi: 8368	Ukrainian: 8575
Azerbaijani: 6590	Faroese: 7079	Japanese: 7465	Mongolian: 7778	Singhalese: 8373	Urdu: 8582
Bashkir: 6665	Fiji: 7074	Javanese: 7487	Nauru: 7865	Slovak: 8375	Uzbek: 8590
Basque: 6985	Finnish: 7073	Kannada: 7578	Nepali: 7869	Slovenian: 8376	Vietnamese: 8673
Bengali; Bangla: 6678	French: 7082	Kashmiri: 7583	Norwegian: 7879	Somali: 8379	Volapük: 8679
Bhutani: 6890	Frisian: 7089	Kazakh: 7575	Oriya: 7982	Spanish: 6983	Welsh: 6789
Bihari: 6672	Galician: 7176	Kirghiz: 7589	Pashto, Pushto: 8083	Sundanese: 8385	Wolof: 8779
Breton: 6682	Georgian: 7565	Korean: 7579	Persian: 7065	Swahili: 8387	Xhosa: 8872
Bulgarian: 6671	German: 6869	Kurdish: 7585	Polish: 8076	Swedish: 8386	Yiddish: 7473
Burmese: 7789	Greek: 6976	Laotian: 7679	Portuguese: 8084	Tagalog: 8476	Yoruba: 8979
Byelorussian: 6669	Greenlandic: 7576	Latin: 7665	Punjabi: 8065	Tajik: 8471	Zulu: 9085
Cambodian: 7577	Guarani: 7178	Latvian, Lettish: 7686	Quechua: 8185	Tamil: 8465	
Catalan: 6765	Gujarati: 7185	Lingala: 7678	Rhaeto-Romance: 8277	Tatar: 8484	

Limited Warranty (ONLY FOR U.S.A.)

Panasonic Consumer Electronics Company,
Division of Matsushita Electric Corporation of America
One Panasonic Way Secaucus, New Jersey 07094

Panasonic Sales Company, Division of Matsushita Electric of Puerto Rico, Inc.

Ave. 65 de Infantería, Km. 9.5
San Gabriel Industrial Park, Carolina, Puerto Rico 00985

Panasonic Audio Products Limited Warranty

Limited Warranty Coverage

If your product does not work properly because of a defect in materials or workmanship, Panasonic Consumer Electronics Company or Panasonic Sales Company (collectively referred to as "the warrantor") will, for the length of the period indicated on the chart below, which starts with the date of original purchase ("warranty period"), at its option either (a) repair your product with new or refurbished parts, or (b) replace it with a new or a refurbished product. The decision to repair or replace will be made by the warrantor.

Product or Part Name	Parts	Labor
Audio Products (except items listed below)	One (1) year	One (1) year
All Audio Racks (cabinets)	Thirty (30) days	Not Applicable
Stand Alone Speakers, Subwoofer Speakers	Three (3) years	Three (3) years
USB Reader-Writer, Personal Computer Card Adapters (in exchange for defective item)	One (1) year	Not Applicable
Accessories: Headphones, Cartridges, Microphones, Adapters	Ninety (90) days	Ninety (90) days
Rechargeable Batteries, DVD-R/-RAM Discs (in exchange for defective item)	Ten (10) days	Not Applicable
SD Memory Cards, Rechargeable Battery Packs (in exchange for defective item)	Ninety (90) days	Not Applicable

During the "Labor" warranty period there will be no charge for labor. During the "Parts" warranty period, there will be no charge for parts. You must carry-in or mail-in your product during the warranty period. If non-rechargeable batteries are included, they are not warranted. This warranty only applies to products purchased and serviced in the United States or Puerto Rico. This warranty is extended only to the original purchaser of a new product which was not sold "as is". A purchase receipt or other proof of the original purchase date is required for warranty service.

Carry-In or Mail-In Service

For Carry-In or Mail-In Service in the United States call 1-800-211-PANA (1-800-211-7262) or visit Panasonic web site: <http://www.panasonic.com>

For assistance in Puerto Rico call Panasonic Sales Company (787)-750-4300 or fax (787)-768-2910.

Limited Warranty Limits And Exclusions

This warranty ONLY COVERS failures due to defects in materials or workmanship, and DOES NOT COVER normal wear and tear or cosmetic damage. The warranty ALSO DOES NOT COVER damages which occurred in shipment, or failures which are caused by products not supplied by the warrantor, or failures which result from accidents, misuse, abuse, neglect, mishandling, misapplication, alteration, faulty installation, set-up adjustments, misadjustment of consumer controls, improper maintenance, power line surge, lightning damage, modification, or commercial use (such as in a hotel, office, restaurant, or other business), rental use of the product, service by anyone other than a Factory Servicenter or other Authorized Servicer, or damage that is attributable to acts of God.

THERE ARE NO EXPRESS WARRANTIES EXCEPT AS LISTED UNDER "LIMITED WARRANTY COVERAGE". THE WARRANTOR IS NOT LIABLE FOR INCIDENTAL OR CONSEQUENTIAL DAMAGES RESULTING FROM THE USE OF THIS PRODUCT, OR ARISING OUT OF ANY BREACH OF THIS WARRANTY. (As examples, this excludes damages for lost time, travel to and from the servicer, loss of media or images, data or other memory content. The items listed are not exclusive, but are for illustration only.) **ALL EXPRESS AND IMPLIED WARRANTIES, INCLUDING THE WARRANTY OF MERCHANTABILITY, ARE LIMITED TO THE PERIOD OF THE LIMITED WARRANTY.**

Some states do not allow the exclusion or limitation of incidental or consequential damages, or limitations on how long an implied warranty lasts, so the exclusions may not apply to you. This warranty gives you specific legal rights and you may also have other rights which vary from state to state. If a problem with this product develops during or after the warranty period, you may contact your dealer or Servicenter. If the problem is not handled to your satisfaction, then write to the warrantor's Consumer Affairs Department at the addresses listed for the warrantor.

PARTS AND SERVICE WHICH ARE NOT COVERED BY THIS LIMITED WARRANTY ARE YOUR RESPONSIBILITY.

Customer Services Directory

Obtain Product Information and Operating Assistance; locate your nearest Dealer or Servicenter; purchase Parts and Accessories; or make Customer Service and Literature requests by visiting our Web Site at:

<http://www.panasonic.com/support>

or, contact us via the web at:

<http://www.panasonic.com/contactinfo>

You may also contact us directly at:

1-800-211-PANA (7262),

Monday-Friday 9 am-9 pm; Saturday-Sunday 10 am-7 pm, EST.

For hearing or speech impaired TTY users, TTY : 1-877-833-8855

Accessory Purchases

Purchase Parts, Accessories and Instruction Books online for all Panasonic Products by visiting our Web Site at:

<http://www.pasc.panasonic.com>

or, send your request by E-mail to:

npcparts@panasonic.com

You may also contact us directly at:

1-800-332-5368 (Phone) 1-800-237-9080 (Fax Only) (Monday – Friday 9 am to 8 pm, EST.)

Panasonic Services Company

20421 84th Avenue South, Kent, WA 98032

(We Accept Visa, MasterCard, Discover Card, American Express, and Personal Checks)

For hearing or speech impaired TTY users, TTY : 1-866-605-1277

Service in Puerto Rico

Matsushita Electric of Puerto Rico, Inc. Panasonic Sales Company

Factory Servicenter:

Ave. 65 de Infantería, Km. 9.5, San Gabriel Industrial Park, Carolina, Puerto Rico 00985

Phone (787)750-4300, Fax (787)768-2910

Limited Warranty (ONLY FOR U.S.A.)

For U.S.A.

**Panasonic Consumer Electronics
Company, Division of Matsushita
Electric Corporation of America**

One Panasonic Way Secaucus,
New Jersey 07094
<http://www.panasonic.com>

**Panasonic Sales Company,
Division of Matsushita Electric of
Puerto Rico, Inc. ("PSC")**

Ave. 65 de Infantería, Km. 9.5
San Gabriel Industrial Park, Carolina,
Puerto Rico 00985

For Canada

Panasonic Canada Inc.

5770 Ambler Drive
Mississauga, Ontario
L4W 2T3
www.panasonic.ca

For units with PX printed on the outer packaging

**Matsushita Electric Industrial Co., Ltd.
Corporate Management Division for
the Americas**

**Sales Office for North America
Tokyo Panasonic Sales Section**

32nd Floor, World Trade Center 4-1,
Hamamatsu-cho, 2-Chome, Minato-Ku,
Tokyo 105-6132, Japan

**Panasonic Marketing Europe
G.M.B.H. Wiesbaden N.
(a Division of Panasonic Marketing
G.M.B.H.)**

Military Sales Department

6200 Wiesbaden-Biebrich,
Hagenauerstr. 43
Germany

For others

Matsushita Electric Industrial Co., Ltd.

Web Site: <http://www.panasonic.co.jp/global/>