

**POWER MANAGEMENT****Description**

The SC1175 is a versatile 2 phase, synchronous, voltage mode PWM controller that may be used in two distinct ways. First, the SC1175 is ideal for applications where point of use output power exceeds any single input power budget. Alternatively, the SC1175 can be used as a dual switcher. The SC1175 features a temperature compensated voltage reference, over current protection with 50% fold-back and internal level-shifted, high-side drive circuitry.

In current sharing configuration, the SC1175 can produce a single output voltage from two separate voltage sources (which can be different voltage levels) while maintaining current sharing between the channels. Current sharing is programmable to allow loading each input supply as required by the application.

In dual switcher configuration, two feedback paths are provided for independent control of the separate outputs. The device will provide a regulated output from flexibly configured inputs (3.3V, 5V, 12V), provided 5V is present for  $V_{CC}$ . The two switchers are  $180^\circ$  out of phase to minimize input and output ripple.

**Features**

- ◆ 300kHz fixed frequency operation
- ◆ Soft Start and Enable function
- ◆ Power Good output provided
- ◆ Over current protection with 50% fold-back
- ◆ Phase-shifted switchers minimize ripple
- ◆ High efficiency operation, >90%
- ◆ Programmable output(s) as low as 1.25V
- ◆ Industrial temperature range
- ◆ 20 pin SOIC or TSSOP package

**Two Phase, Current Sharing Controller**

- ◆ Flexible, same or separate  $V_{IN}$
- ◆ Programmable current sharing
- ◆ Combined current limit with fold-back
- ◆ 2 phases operating opposed for ripple reduction
- ◆ Thermal distribution via multi-phase output

**Two Independent PWM Controllers**

- ◆ Flexible, same or separate  $V_{IN}$
- ◆ Independent control for each channel
- ◆ Independent and separate current limit
- ◆ 2 phases operating opposed for ripple reduction (if same  $V_{IN}$  used)

**Applications**

- ◆ Graphics cards
- ◆ DDR Memory
- ◆ Peripheral add-in card
- ◆ SSTL Termination
- ◆ Dual-Phase power supply
- ◆ Power supplies requiring two outputs

**POWER MANAGEMENT**

**Typical Application Circuit**

**2 Channels with Current Sharing**

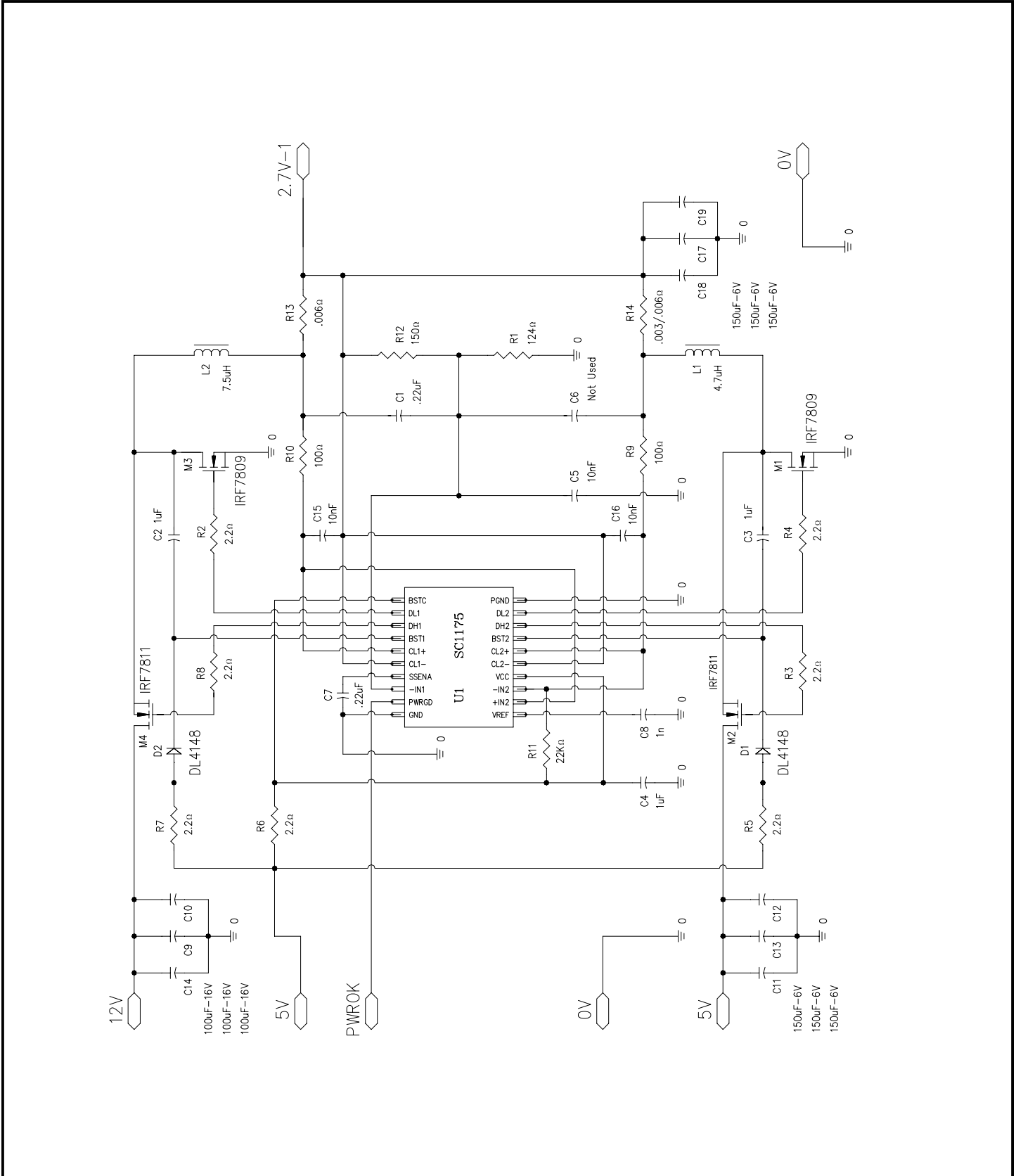

**POWER MANAGEMENT**
**Absolute Maximum Rating**

Exceeding the specifications below may result in permanent damage to the device, or device malfunction. Operation outside of the parameters specified in the Electrical Characteristics section is not implied.

Parameter	Symbol	Limits	Units
V <sub>CC</sub> to GND	V <sub>IN</sub>	-0.3 to 15	V
PGND to GND		± 1	V
BST to GND		-0.3 to 26	V
Thermal Resistance Junction to Case	θ <sub>JC</sub>	30	°C/W
Thermal Resistance Junction to Ambient	θ <sub>JA</sub>	90	°C/W
Operating Ambient Temperature Range	T <sub>A</sub>	0 to 85	°C
Operating Junction Temperature Range	T <sub>J</sub>	0 to 125	°C
Storage Temperature Range	T <sub>STG</sub>	-65 to +150	°C
Lead Temperature (Soldering) 10 sec	T <sub>LEAD</sub>	300	°C

**Electrical Characteristics**

Unless Specified: V<sub>CC</sub> = 4.75 to 5.25V, GND = PGND = 0V, FB = V<sub>O</sub>, 0mV < (CS(+)) - CS(-) < 60mV, T<sub>J</sub> = 25°C

PARAMETER	CONDITIONS	MIN	TYP	MAX	UNITS
Output Voltage	I <sub>O</sub> = 2A <sup>(1)</sup> , V <sub>OUT</sub> set to 2.75V	2.65	2.75	2.85	V
Supply Voltage	V <sub>CC</sub>	4.2		15	V
Supply Current	V <sub>CC</sub> = 5.0		10		mA
Reference		1.2375	1.25	1.2625	V
Load Regulation	I <sub>O</sub> = 0.3A to 15A <sup>(1)</sup>		1		%
Reference Line Regulation	5V < V <sub>CC</sub> < 15V			.5	%
Output Line Regulation	5V < V <sub>IN</sub> < 15V			.5	%
Gain (A <sub>OL</sub> )	V <sub>OSENSE</sub> to V <sub>O</sub>		35		dB
Current Limit Voltage		60	70	80	mV
Oscillator Frequency		270	300	330	kHz
Oscillator Max Duty Cycle		90	95		%
DH Sink Current	DH - PGND = 3.5V	1			A
DH Sink Current	DH - PGND = 1.75V	.5			A
DH Source Current	BSTH - DH = 5.0V	1			A
DH Source Current	BSTH - DH = 2.5V	.5			A

**POWER MANAGEMENT**
**Electrical Characteristics (Cont.)**

 Unless Specified:  $V_{CC} = 4.75$  to  $5.25V$ ,  $GND = PGND = 0V$ ,  $FB = V_O$ ,  $0mV < (CS(+)) - CS(-) < 60mV$ ,  $T_J = 25^\circ C$ 

PARAMETER	CONDITIONS	MIN	TYP	MAX	UNITS
DL Sink Current	DL - PGND = 3.5V	1			A
DL Sink Current	DL - PGND = 1.75V	.5			A
DL Source Current	BSTL - DL = 5V	1			A
DL Source Current	BSTL - DL = 2.5V	.5			A
Dead Time	Note 5	50	100	150	ns
Soft Start Charge Current <sup>(2)</sup>			25		$\mu A$
Soft Start Enable	0% duty cycle		1.4		V
Soft Start End	100% duty cycle		2.5		V
Soft Start Transition <sup>(2)</sup>	Synchronous mode		3.3		V
Power Good Window <sup>(3)</sup>			+10		$\%V_{OUT}$
Fold Back Current	$V_{OUT} = 0V$		50%		$I_{LIM}$
Fold Back Voltage Knee	$I = I_{LIM}$	1.25		$V_{OUT}$	V
Input Bias Current	-IN1, +IN2, -IN2			1	$\mu A$

**NOTES:**

- (1) Specification refers to application circuit.
- (2) The soft start pin sources  $25\mu A$  to an external capacitor. The converter operates in synchronous mode above the soft start transition threshold and in asynchronous mode below it.
- (3) Power good is an open collector pulled low when the output voltage is outside the  $\pm 10\%$  window.
- (4) This device is ESD sensitive. Use of standard ESD handling precautions is required.
- (5) 200ns maximum at  $70^\circ$ .

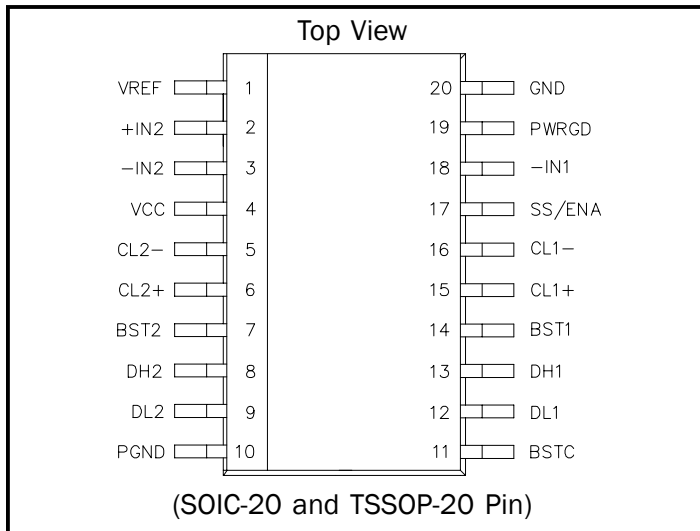
**POWER MANAGEMENT**
**Pin Configuration**

**Pin Descriptions**
**Expanded Pin Description**
**Pin 1:** (VREF)

Internal 1.25V reference  
Connected to the + input of the master channel error amplifier.

**Pin 2:** (+IN)

+ Input of slave channel error amplifier.  
Connected to 1.25V reference (Pin 1) for the two independent channel configuration.

**Pin 3, 18:** (-IN2, -IN1)

- Inputs of close loop error amplifiers.  
Works as a feedback inputs (For both modes).

**Pin 4:** (VCC)

VCC chip supply voltage.  
15V maximum, 10mA typical.  
Needs a 1 $\mu$ F ceramic multilayer decoupling capacitor to GND (Pin 20).

**Pin 5, 6, 15, 16:** (CL2-, CL2+, CL1+, CL1-)

Pins (-) and (+) of the current limit amplifiers for both channels.  
Connected to output current sense resistors. Compares that sense voltage to internal 75mV reference.  
Needs RC filter for noise rejection.

**Pin 7, 14:** (BST2, BST1)

BST signal. Supply for high side driver.  
Can be connected to a high enough voltage source.  
Usually connected to bootstrap circuit.

**Pin 8, 13:** (DH2, DH1)

DH signal (Drive High).  
Gate drive for top MOSFETs.  
Requires a small series resistor.

**Ordering Information**

Device <sup>(1)</sup>	Package
SC1175CSW.TR	SOIC-20
SC1175CSWTRT <sup>(2)</sup>	
SC1175TS.TR	TSSOP-20
SC1175TSTRT <sup>(2)</sup>	
SC1175EVB-1	Current Share Version Evaluation Board
SC1175EVB-2	Dual Channel Version Evaluation Board

**Notes:**

(1) Only available in tape and reel packaging. A reel contains 1000 (SOIC) and 2500 (TSSOP) devices.

(2) Lead free product. This product is fully WEEE and RoHS compliant.

**Pin 9, 12:** (DL2, DL1)

DL signal (Drive Low).  
Gate drive for bottom MOSFETs.  
Requires a small series resistor.

**Pin 10:** (PGND)

Power GND. Return of gate drive currents.

**Pin 11:** (BSTC)

Supply for bottom MOSFETs gate drive.

**Pin 17:** (SS/ENA)

Soft start pin. Internal current source connected to external capacitor.  
Inhibits the chip if pulled down.

**Pin 19:** (PWRGD)

Power good signal.  
Open collector signal .  
Turns to 0 if output voltage is outside the power good window.

**Pin 20:** (GND)

Analog GND.

**POWER MANAGEMENT**

**Block Diagram**

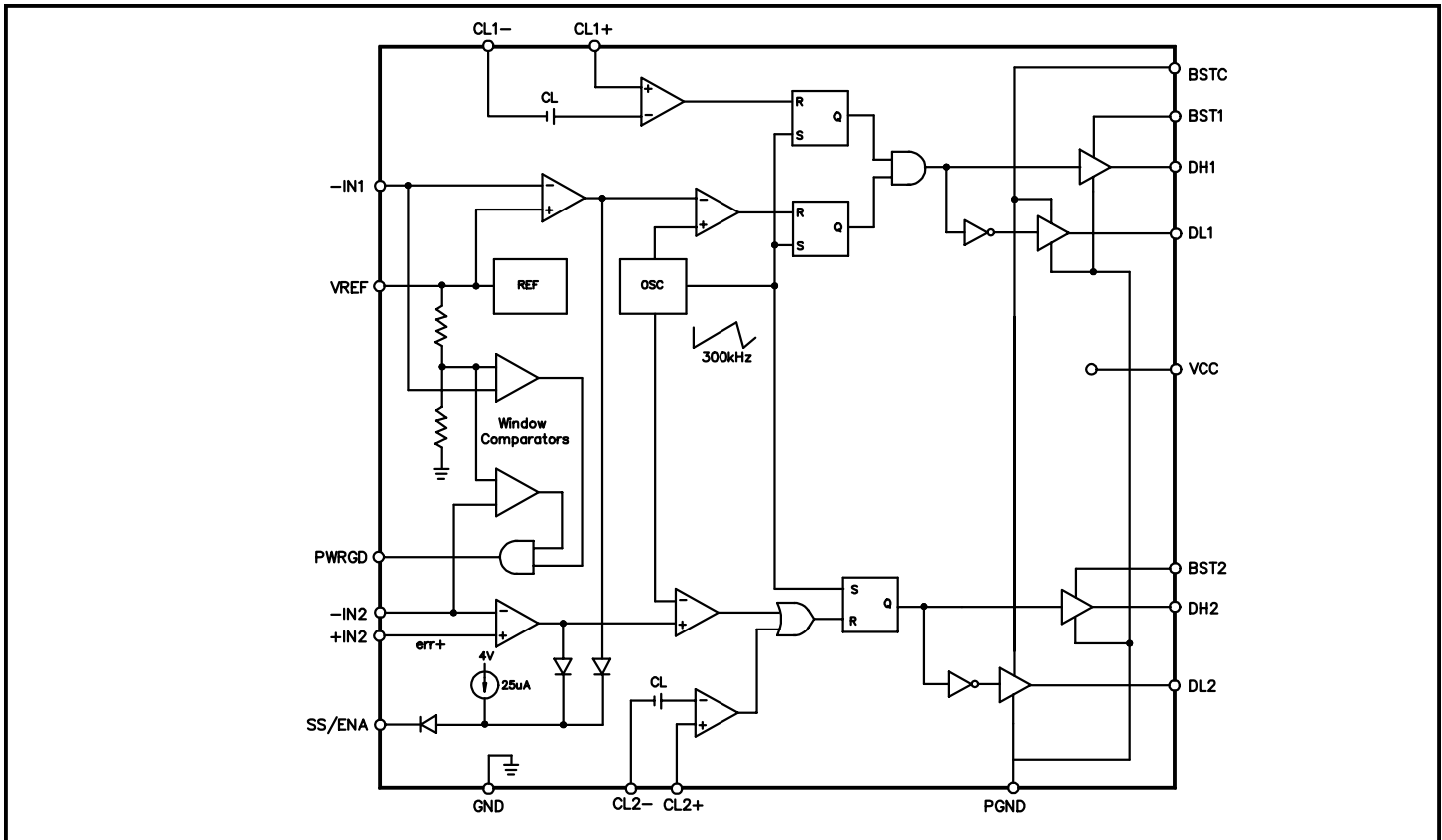

**NOTES**

- (1) Block 1 (top) is the Master and Block 2 (bottom) is the Slave in current sharing configuration.
- (2) For independent operation there is no Master or Slave.

**Applications Information - Theory of Operation**

**Main Loop(s)**

The SC1175 is a dual, voltage mode synchronous Buck controller, the two separate channels are identical and share only IC supply pins (Vcc and GND), output driver ground (PGND) and pre-driver supply voltage (BSTC). They also share a common oscillator generating a sawtooth waveform for channel 1 and an inverted sawtooth for channel 2. Each channel has its own current limit comparator. Channel 1 has the positive input of the error amplifier internally connected to Vref. Channel 2 has both inputs of the error amplifier uncommitted and available externally. This allows the SC1175 to operate in two distinct modes.

back path from their own output. In this mode, the positive input of error amplifier 2 is connected externally to Vref. If the application uses a common input voltage, the sawtooth phase shift between the channels provides some measure of input ripple current cancellation.

b) Two channels operating in current sharing mode with common output voltage and either common input voltage or different input voltages. In this mode, channel 1 operates as a voltage mode Buck controller, as before, but error amp 2 monitors and amplifies the difference in voltage across the output current sense resistors of channel 1 and channel 2 (Master and Slave) and adjusts the Slave duty cycle to match output currents. Because of finite gain and offsets in the loop, the resistor ratio for perfect current matching is not 1:1. The Master and Slave channels still have

- a) Two independent channels with either common or different input voltages and different output voltages. The two channels each have their own voltage feed-

## POWER MANAGEMENT

### Applications Information - Theory of Operation

their own current limits, identical to the independent channel case.

#### Power Good

The controller provides a power good signal. This is an open collector output, which is pulled low if the output voltage is outside of the power good window.

#### Soft Start/Enable

The Soft Start/Enable (SS/ENA) pin serves several functions. If held below the Soft Start Enable threshold, both channels are inhibited. DH1 and DH2 will be low, turning off the top FETs. Between the Soft Start Enable threshold and the Soft Start End threshold, the duty cycle is allowed to increase. At the Soft Start End threshold, maximum duty cycle is reached. In practical applications the error amplifier will be controlling the duty cycle before the Soft Start End threshold is reached. To avoid boost problems during startup in current share mode, both channels start up in asynchronous mode, and the bottom FET body diode is used for recirculating current during the FET off time. When the SS/ENA pin reaches the Soft Start Transition threshold, the channels begin operating in synchronous mode for improved efficiency. The soft start pin sources approximately 25uA and soft start timing can be set by selection of an appropriate soft start capacitor value.

### SENSE RESISTOR SELECTION

#### Current Sharing Mode

Calculation of the three programming resistors to achieve sharing. Three resistors will determine the current sharing load line. First the offset resistor will ensure that the load line crosses the origin (0 Amp on each channel) for sharing at light current. A pull up resistor from the 5V bias ( $V_{CC}$  of the chip) will be used. For low duty cycle on the slave channel (below 50%), the pull up will be on pin

3. For high duty cycle on the slave channel (above 50%), the pull up will be on pin 2.

The formula is:

$$R_{\text{pull-up}} \text{ (K}\Omega\text{)} = 2.1 \times \frac{5 - V_{\text{OUT}}}{.5 - \frac{V_{\text{OUT}} + .1}{V_{\text{SLAVE}}}}$$

100 $\Omega$  being the value of the resistors connecting the pins 2 and 3 to the two output sense resistors.

.1 V is an estimated voltage drop across the MOSFETs.

Positive values go to pin 3, negative to pin 2.

A +20K will be a 20K on pin 3.

A -20K will be a 20K on pin 2.

Now that the offset resistor has been fixed, we need to set up the maximum current for each channel.

Selection of  $R_{\text{SENSE}1}$  for the master channel: (in m ohm)

$$R_{\text{SENSE}1} = 72\text{mV} / I_{\text{max master}}$$

Selection of  $R_{\text{SENSE}2}$  for the slave channel: (in m ohm)

$$R_{\text{SENSE}2} = 72\text{mV} / I_{\text{max slave}}$$

The errors will be minimized if the power components have been sized proportionately to the maximum currents.

#### Independent Channels

Calculation of the two current limiting resistors. There is no need for an offset resistor in the independent channels mode, only the two sense resistors are used:

Selection of  $R_{\text{SENSE}1}$  for the channel 1: (mohms)

$$R_{\text{SENSE}1} = 72\text{mV} / I_{\text{max ch 1}}$$

Selection of  $R_{\text{SENSE}2}$  for the channel 2: (mohms)

$$R_{\text{SENSE}2} = 72\text{mV} / I_{\text{max ch 2}}$$

**POWER MANAGEMENT**

**Typical Characteristics - 2 Channels with Current Sharing**

**Figure 1:**  $V_{OUT}$  vs  $I_{IN(5V)}$  and  $I_{IN(12V)}$  with  $V_{CC}$  applied and 4A load. Soft start capacitor = 10nF.

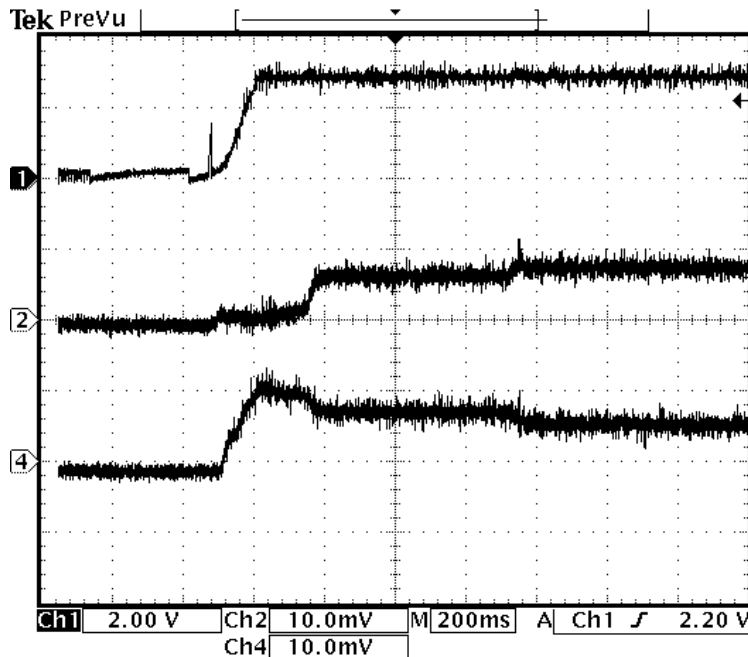

Ch1:  $V_{OUT}$   
Ch2:  $I_{IN(5V)}$  (1A/Div)  
Ch4:  $I_{IN(12V)}$  (1A/Div)  
 $I_{OUT}$ : 4.004 Amps

23 Feb 2000  
09:48:35

**Figure 2:**  $V_{OUT}$  vs  $I_{IN(5V)}$  and  $I_{IN(12V)}$  with  $V_{CC}$  removed and 4A load. Soft start capacitor = 10nF.

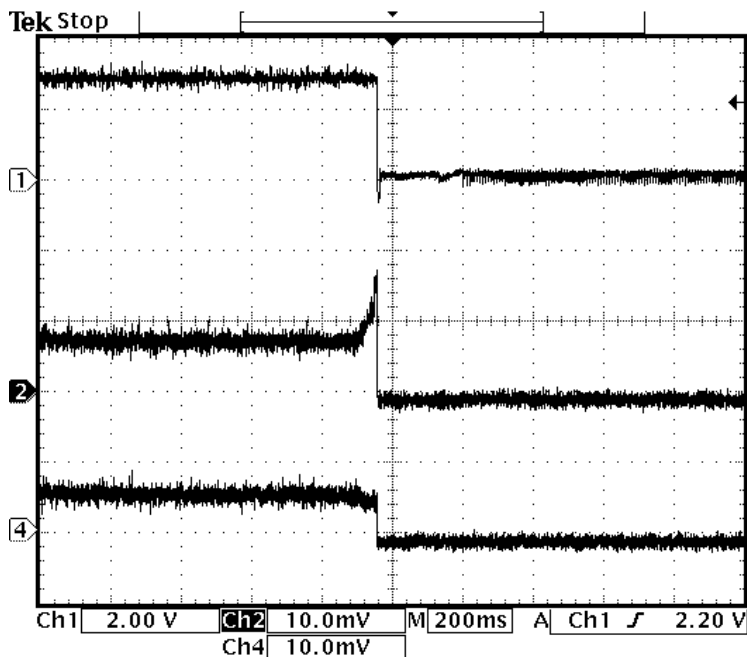

Ch1:  $V_{OUT}$   
Ch2:  $I_{IN(5V)}$  (1A/Div)  
Ch4:  $I_{IN(12V)}$  (1A/Div)  
 $I_{OUT}$ : 4.004 Amps

23 Feb 2000  
10:06:36



**POWER MANAGEMENT**

**Typical Characteristics - 2 Channels with Current Sharing (Cont.)**

**Figure 3:**  $V_{OUT}$  vs  $I_{IN(5V)}$  and  $I_{IN(12V)}$  with  $V_{CC}$  applied and 12A load. Soft start capacitor = 10nF.

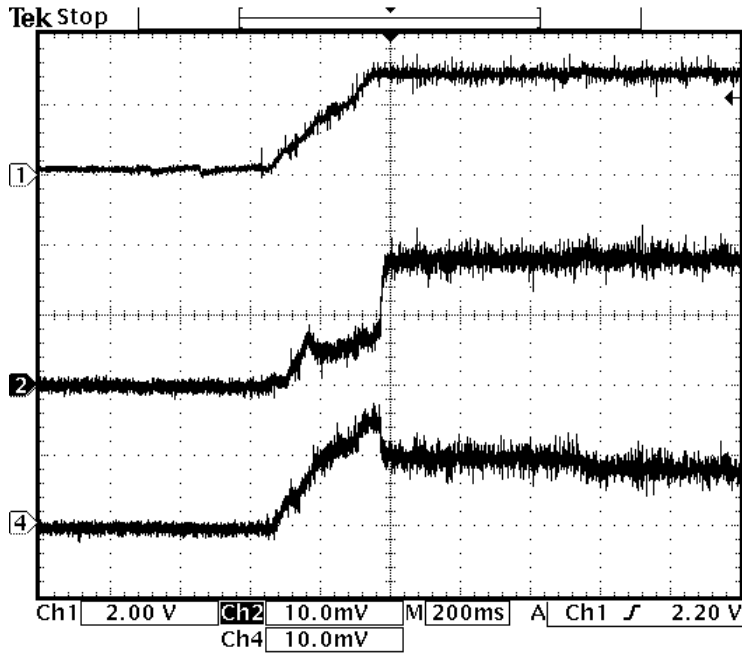

Ch1:  $V_{OUT}$   
Ch2:  $I_{IN(5V)}$  (2A/Div)  
Ch4:  $I_{IN(12V)}$  (2A/Div)  
 $I_{OUT}$ : 12 Amps

23 Feb 2000  
10:17:01

**Figure 4:**  $V_{OUT}$  vs  $I_{IN(5V)}$  and  $I_{IN(12V)}$  with  $V_{CC}$  removed and 12A load. Soft start capacitor = 10nF.

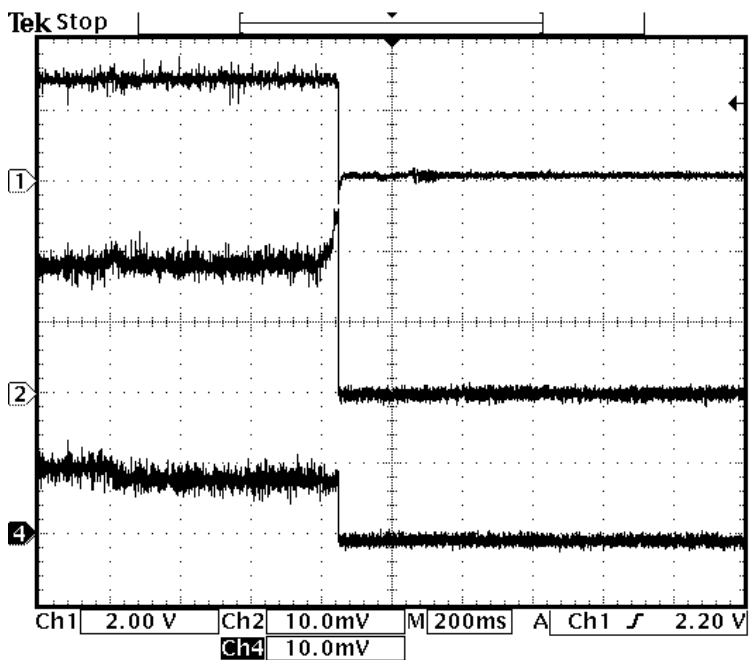

Ch1:  $V_{OUT}$   
Ch2:  $I_{IN(5V)}$  (2A/Div)  
Ch4:  $I_{IN(12V)}$  (2A/Div)  
 $I_{OUT}$ : 12 Amps

23 Feb 2000  
10:26:50

**POWER MANAGEMENT**

Typical Characteristics - 2 Channels with Current Sharing (Cont.)

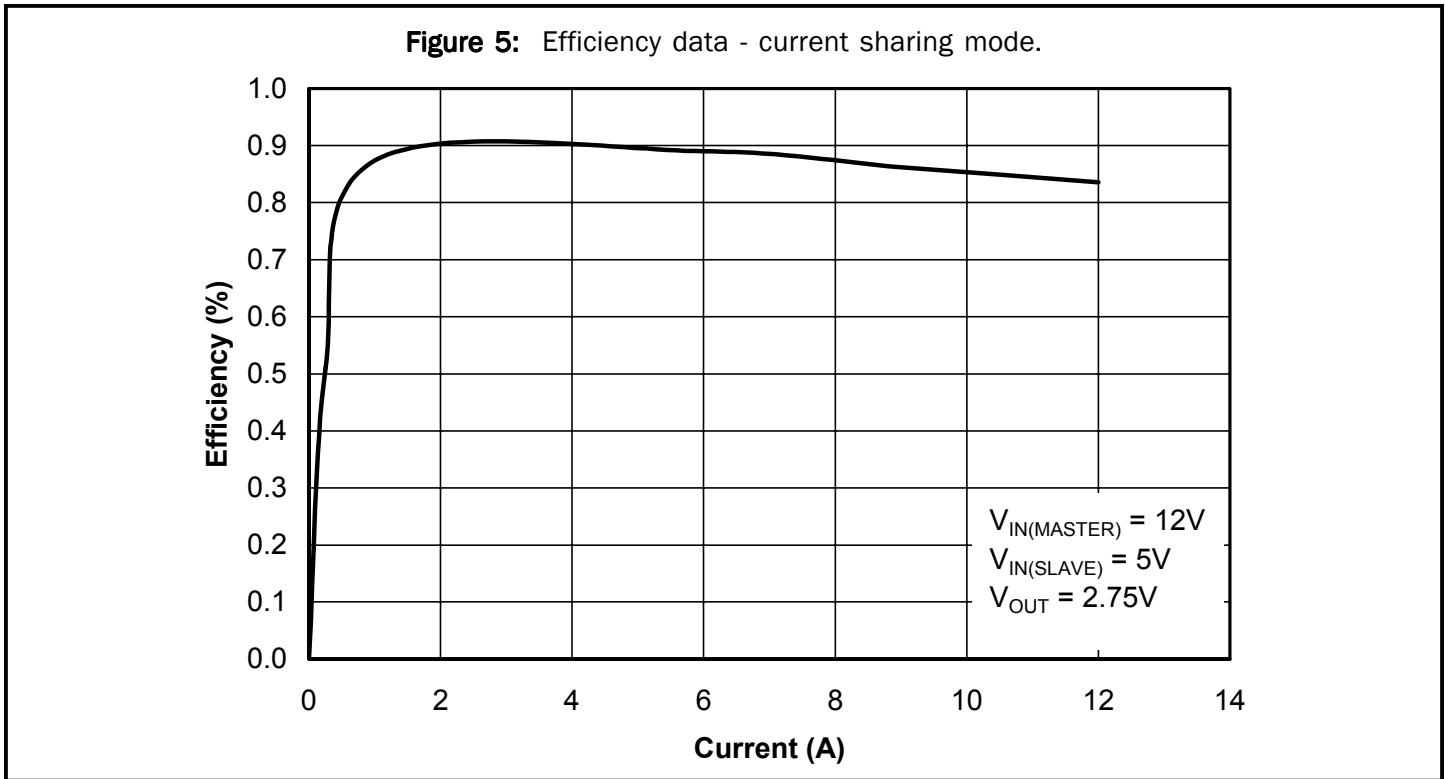

The Current Sharing Evaluation Board is not intended for a specific application. The power components are not optimized for minimum cost and size. This evaluation board should be used to understand the operation of the SC1175. To design with SC1175 for specific current sharing applications, please refer to Application note AN00-3.

**POWER MANAGEMENT**

**Evaluation Board Schematic - 2 Channel with Current Sharing**

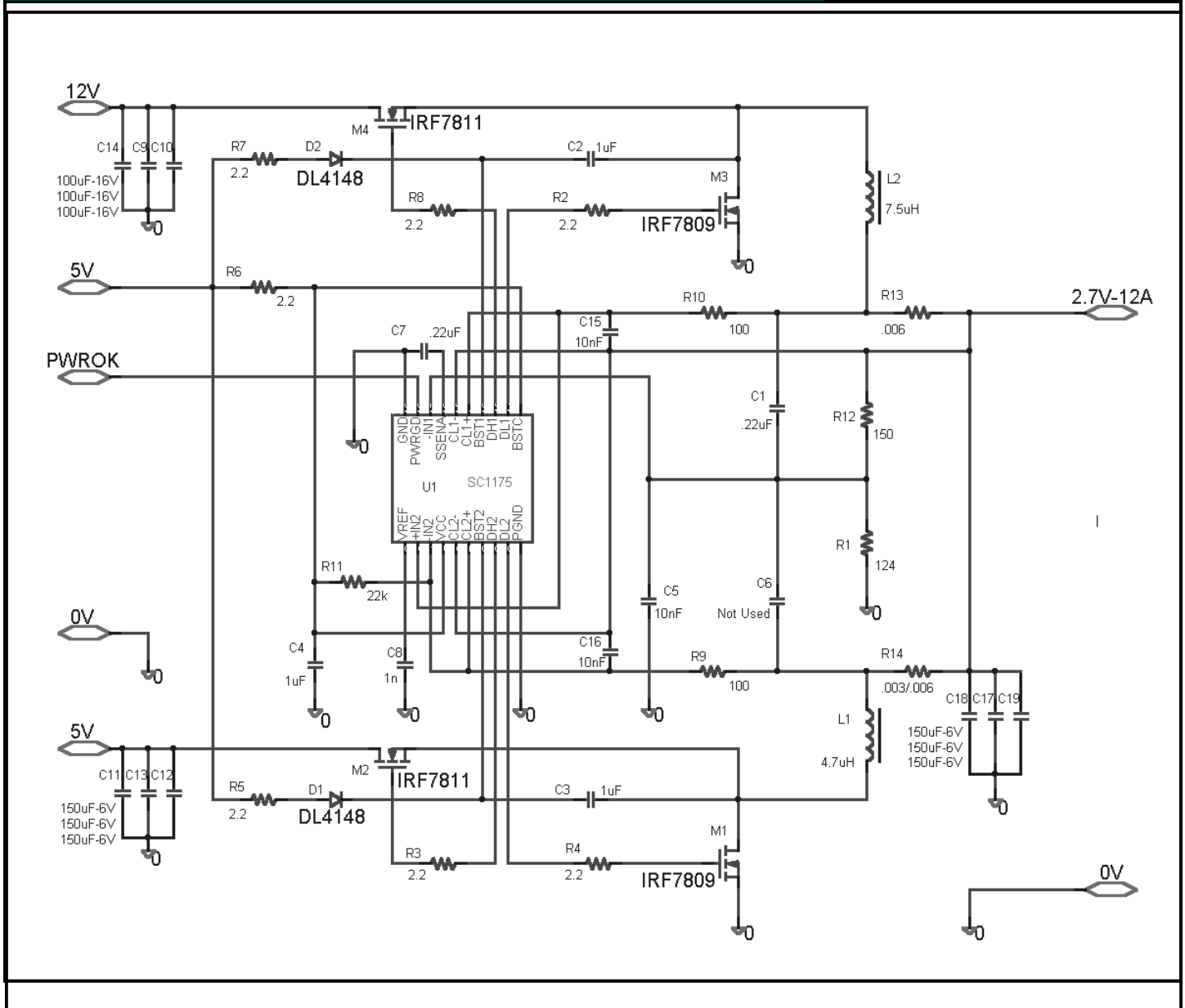

**POWER MANAGEMENT**
**Evaluation Board Bill of Materials - 2 Channels with Current Sharing**

Item	Quantity	Reference	Part
1	2	C1,C7	.22uF, 50V
2	3	C2,C3,C4	1uF, 50V
3	3	C5,C15,C16	10nF, 50V
4	1	C8	1nF, 50V
5	3	C9,C10,C14	100uF, 6V
6	6	C11,C12,C13,C17,C18,C19	150uF, 16V
7	2	D1,D2	DL4148
8	1	L1	7.5uH, 8A
9	1	L2	4.7uH, 8A
10	2	M1,M3	IRF7809 or FDB7030
11	2	M2,M4	IRF7811 or FDB7030
12	1	R1	124
13	7	R2,R3,R4,R5,R6,R7,R8	2.2
14	2	R9,R10	100
15	1	R12	150
16	1	R13	.006
17	1	R14	.003
18	1	U1	SC1175

**POWER MANAGEMENT**

**Evaluation Board Gerber Plots - 2 Channels with Current Sharing**

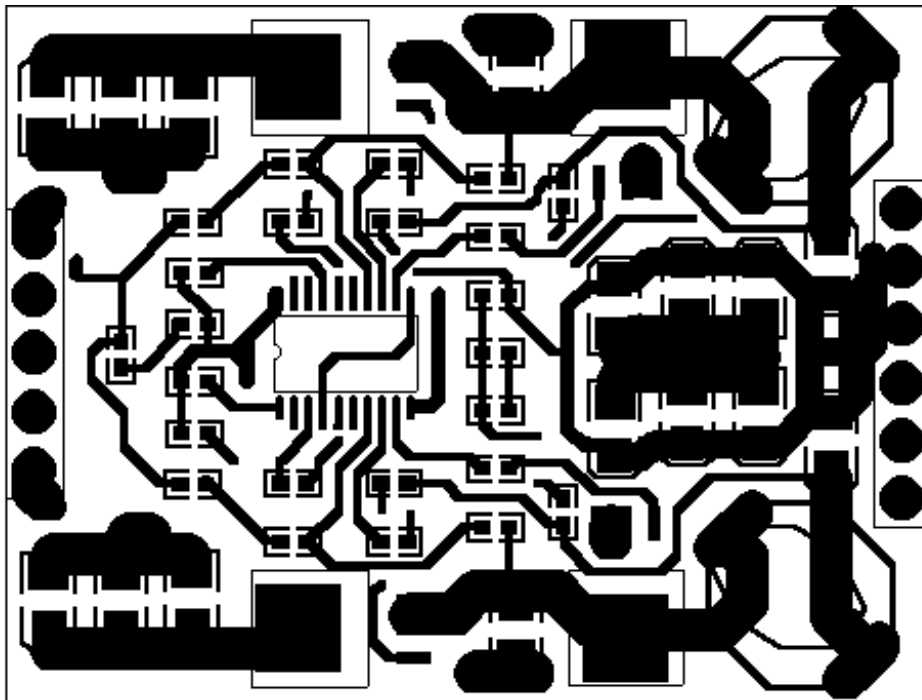

Top Side Traces

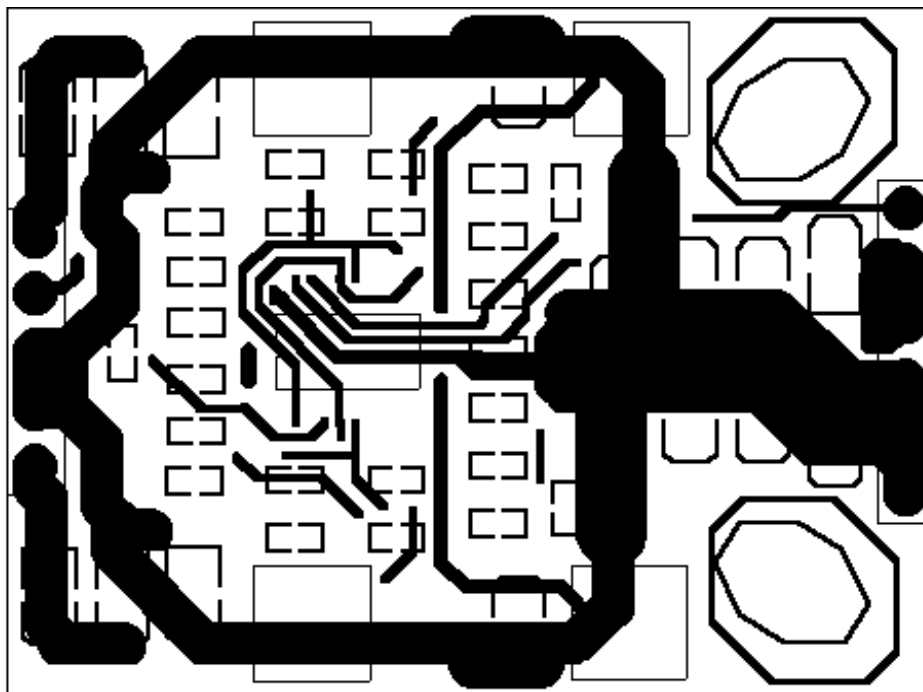

Bottom Side Traces

**POWER MANAGEMENT**

**Typical Characteristics - 2 Independent Channels**

**Figure 6:**

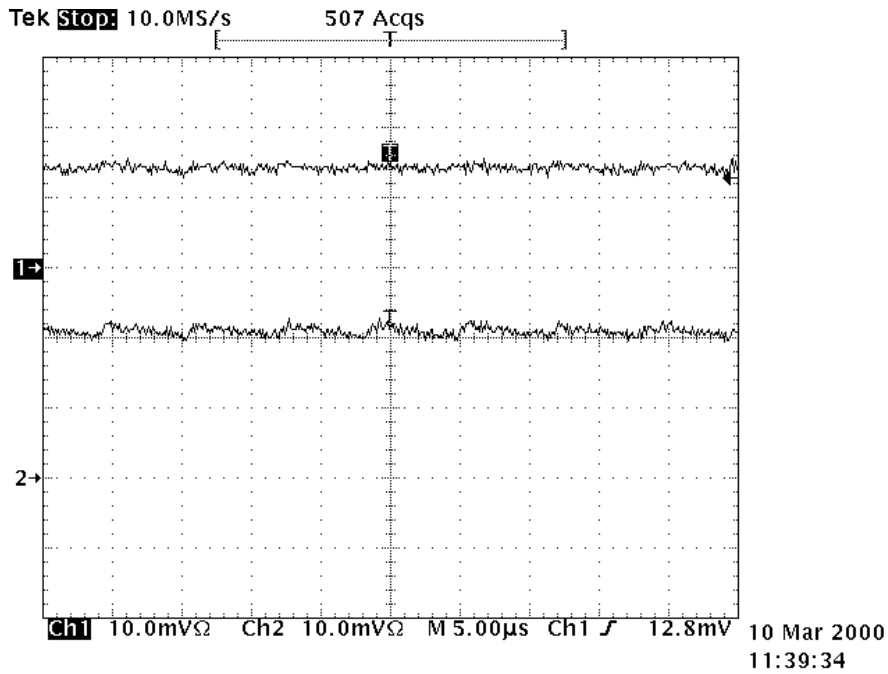

**Figure 7: Output Current**

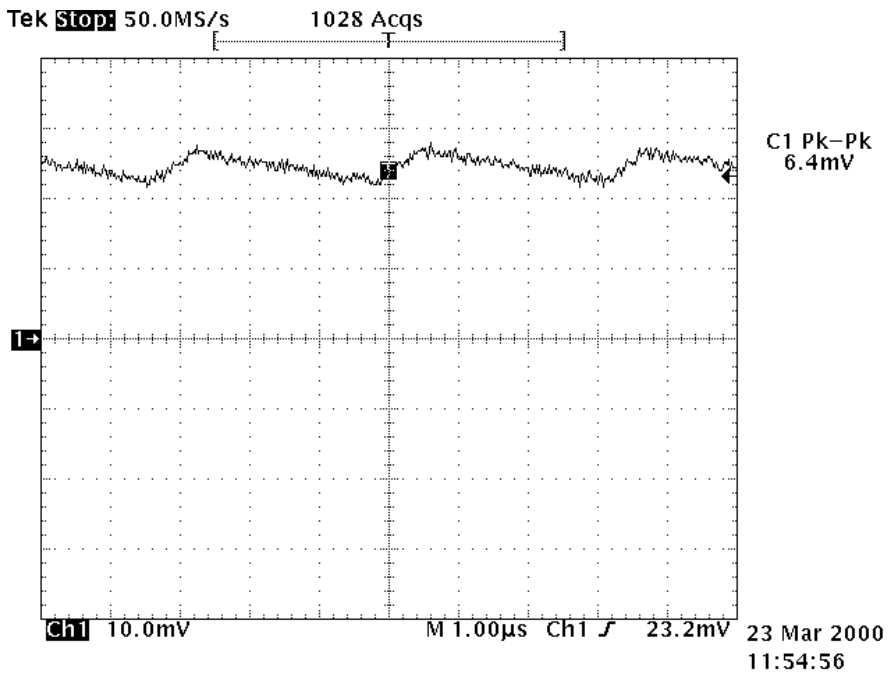

Input Voltage = 12V @ 5Amps. 2A/DIV.

**POWER MANAGEMENT**

Typical Characteristics - 2 Independent Channels (Cont.)

**Figure 8: Peak - Peak Output Ripple @ 5A**

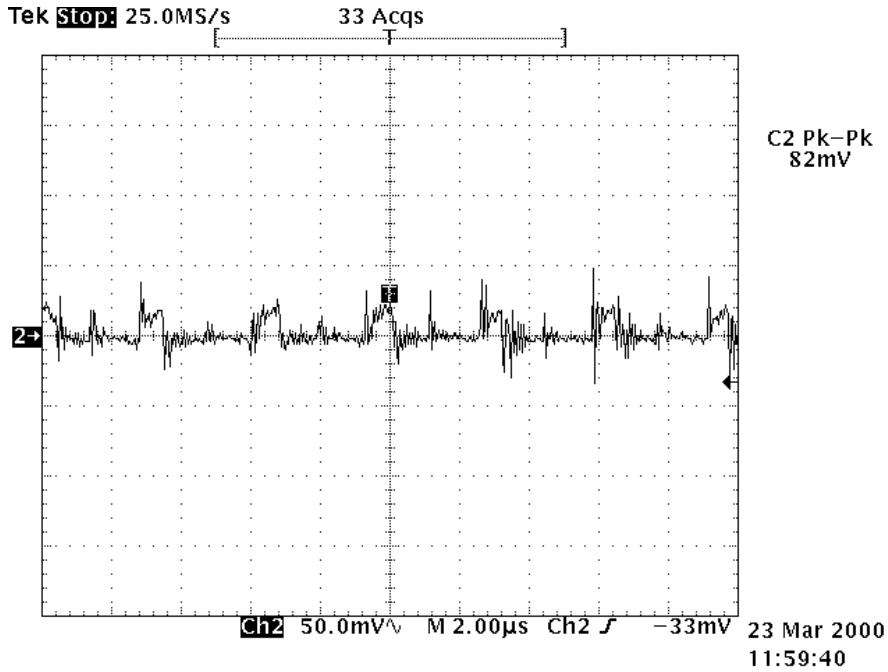

Input Voltage = 12V.  
Output Voltage = 2.0V

**Figure 9: Phase Node 12V Input @ 5A (without snubber and RC network.)**

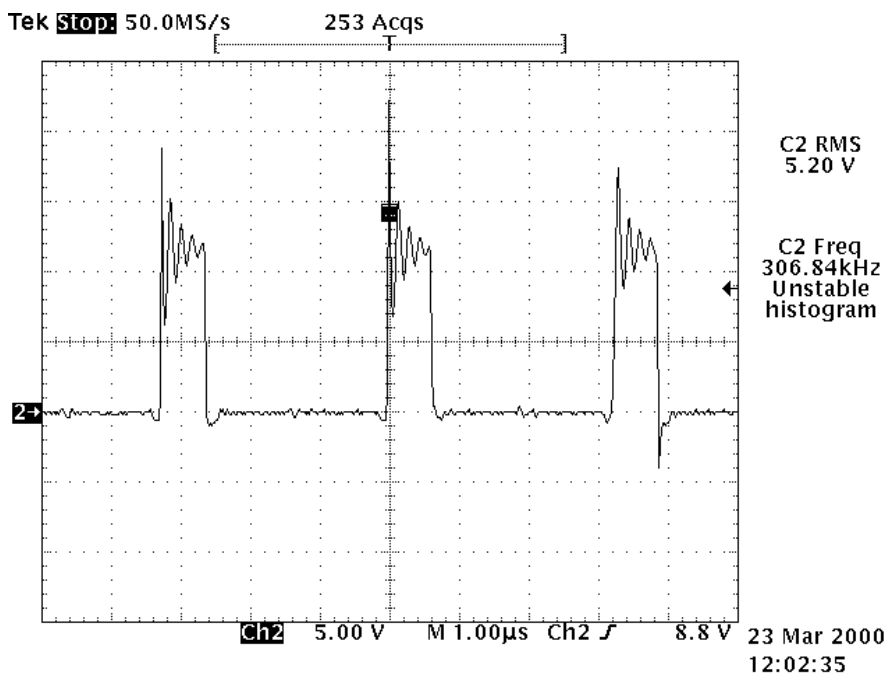

**POWER MANAGEMENT**

Typical Characteristics - 2 Independent Channels (Cont.)

**Figure 10: Start-up Power On**

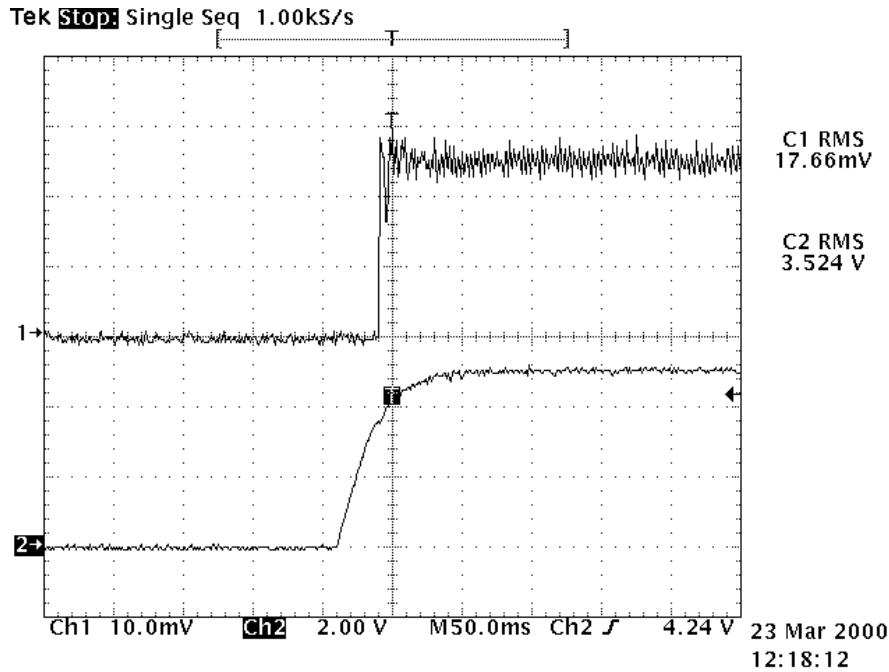

Chan. 1 = Output Current. 2A/DIV.  
Chan. 2 = 5V Bias Voltage

**Figure 11: Power Off**

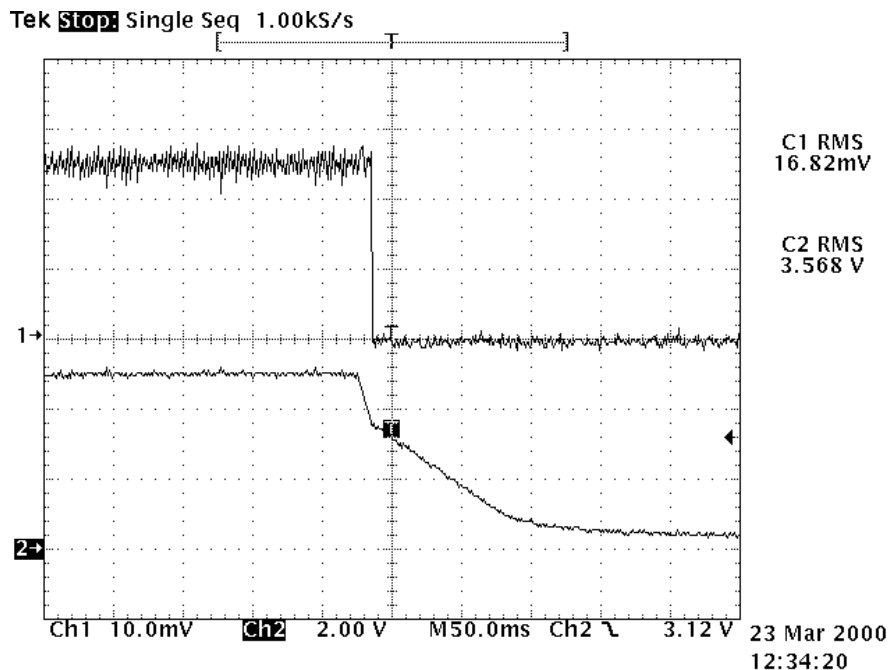

Chan. 1 = Output Current. 2A/DIV.  
Chan. 2 = 5V Bias Voltage



**POWER MANAGEMENT**

**Typical Characteristics - 2 Independent Channels Efficiency Test**

**Figure 12:**

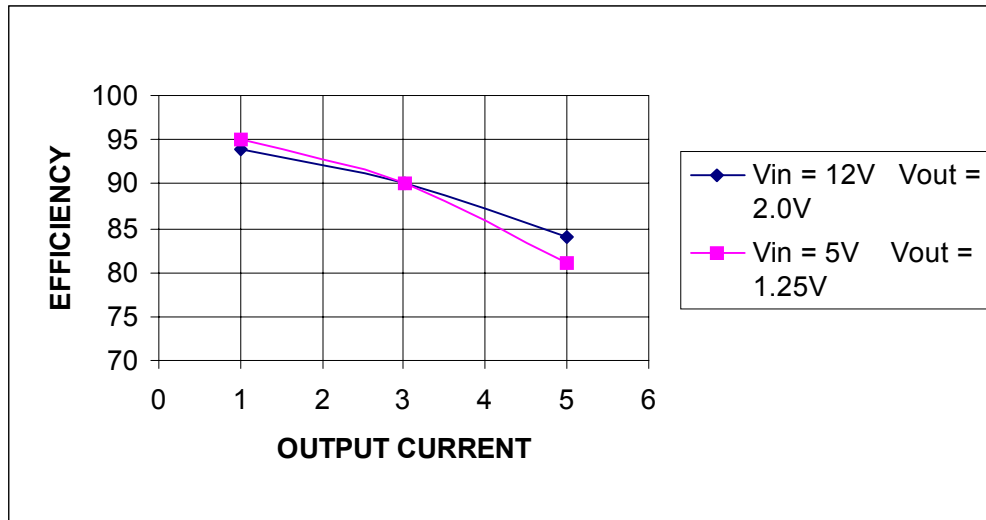

The Independent Channels Evaluation Board is not intended for a specific application. The power components are not optimized for minimum cost and size. This evaluation board should be used to understand the operation of the SC1175.

To design with the SC1175 for specific independent channels applications. Please refer to: Application note AN00-4.

**POWER MANAGEMENT**

**Evaluation Board Schematic - 2 Independent Channels**

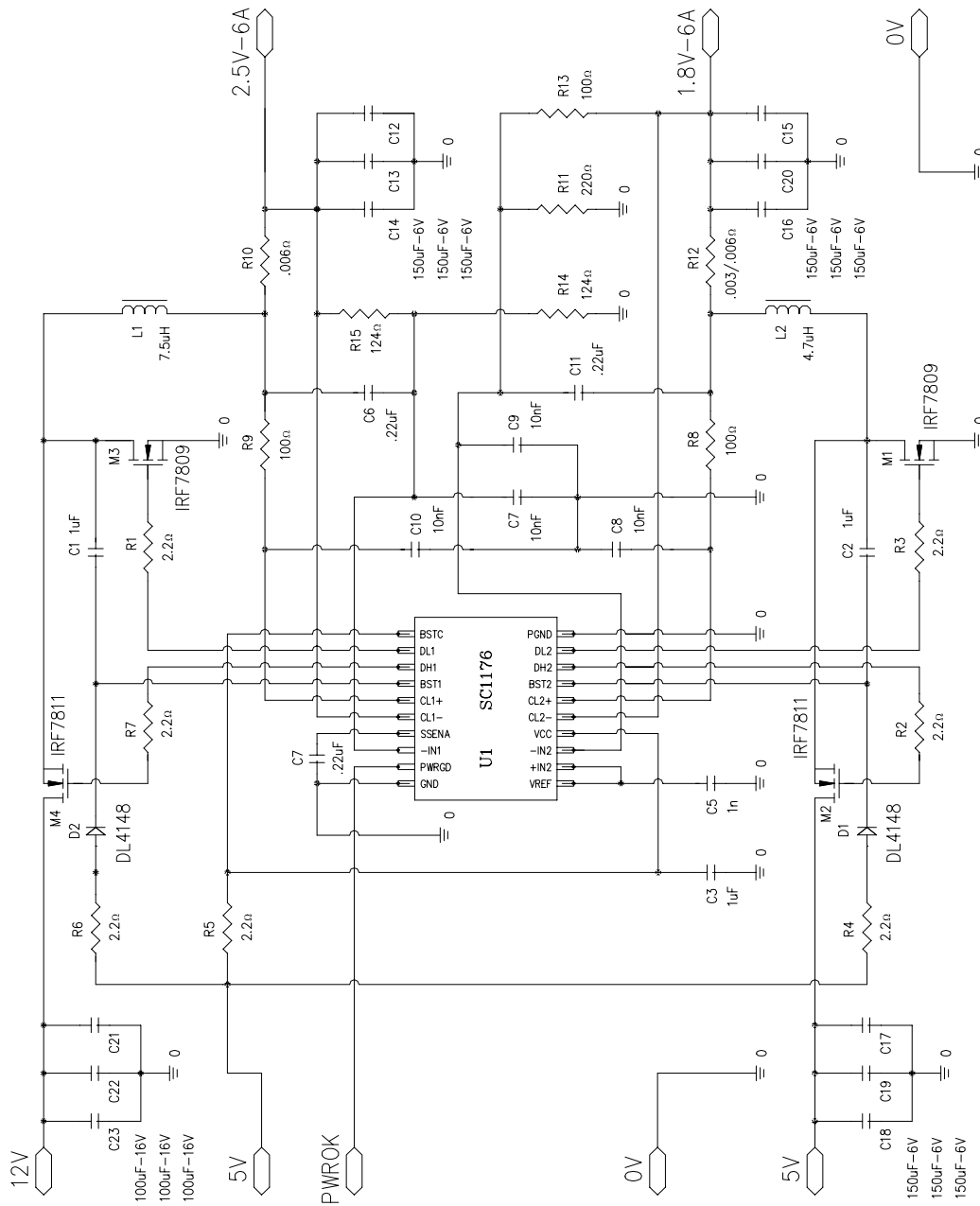

**POWER MANAGEMENT**

**Evaluation Board Bill of Materials - 2 Independent Channels**

Item	Quantity	Reference	Part
1	3	C1,C2,C3	1uF, 50V
2	3	C4,C6,C11	.22uF, 50V
3	1	C5	1nF, 50V
4	4	C7,C8,C9,C10	10nF, 50V
5	9	C12,C13,C14,C15,C16,C17,C18,C19,C20	150uF, 6V
6	3	C21,C22,C23	100uF, 16V
7	2	D1,D2	DL4148
8	1	L1	7.5uH, 8A
9	1	L2	4.7uH, 8A
10	2	M1,M3	IRF7809 or FDB7030
11	2	M2,M4	IRF7811 or FDB7030
12	7	R1,R2,R3,R4,R5,R6,R7	2.2
13	3	R8,R9,R13	100
14	1	R10	.006
15	1	R11	220
16	1	R12	.003
17	2	R14,R15	124
18	1	U1	SC1175

**POWER MANAGEMENT**

Evaluation Board Gerber Plots - 2 Independent Channels

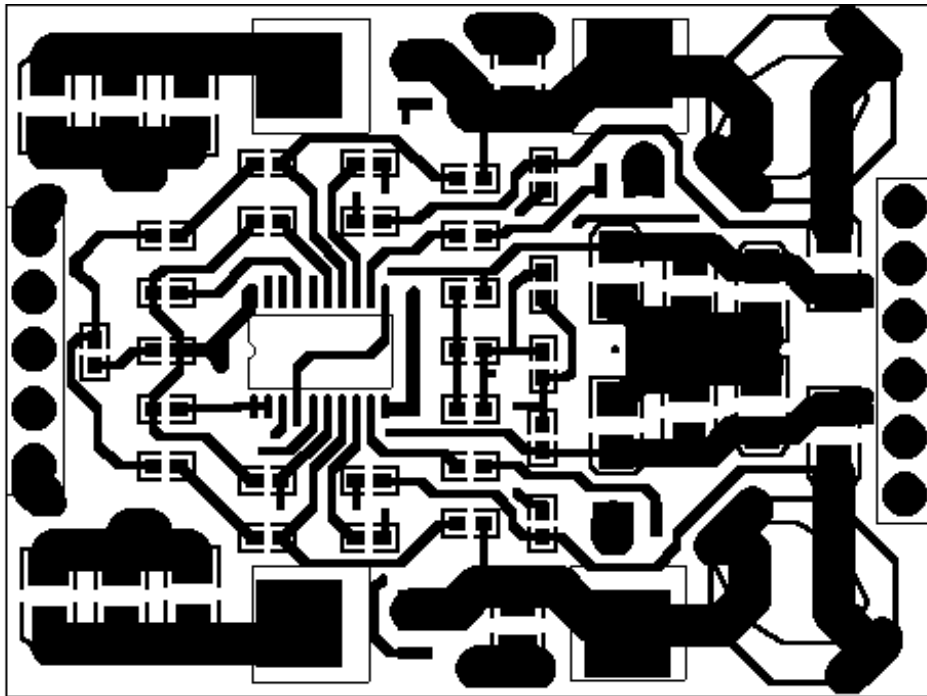

Top Side Traces

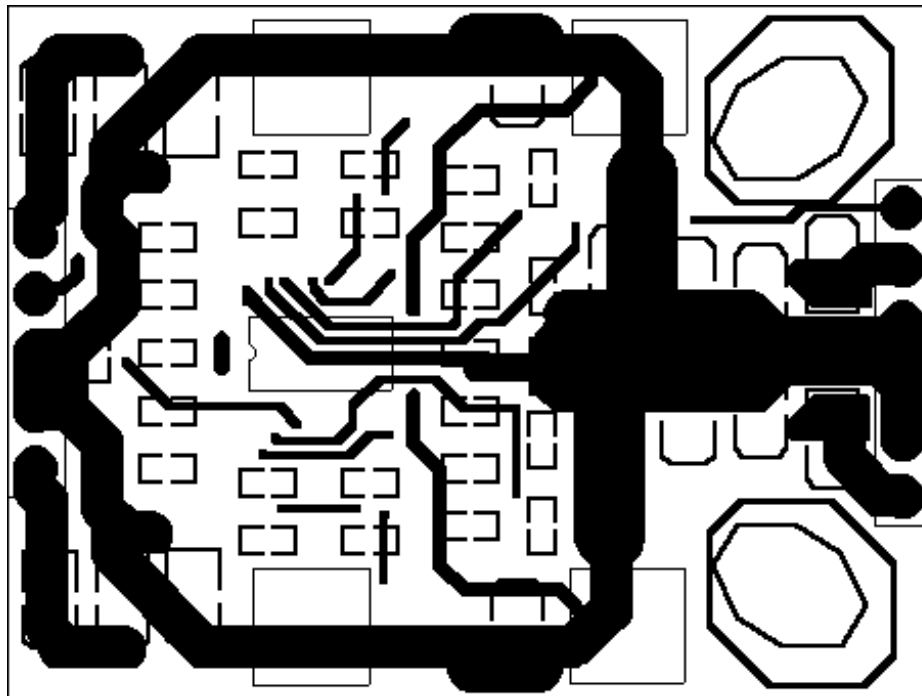

Bottom Side Traces

## POWER MANAGEMENT

Power and signal traces must be kept separated for noise considerations. Feedback, current sense traces and analog ground should not cross any traces or planes carrying high switching currents, such as the input loop or the phase node.

The input loop, consisting of the input capacitors and both MOSFETs must be kept as small as possible. All of the high switching currents occur in this loop. The enclosed loop area must be kept small to minimize inductance and radiated and conducted emissions. Designing for minimum trace length is not always the best approach, often a more optimum layout can be achieved by keeping loop area constraints in mind. It is important to keep gate lengths short, the IC must be close to the power switches. This is more difficult in a dual channel device than a single and requires that the two power paths run on either side of a centrally located controller.

Grounding requirements are always conflicting in a buck converter, especially at high power, and the trick is to achieve the best compromise. Power ground (PGND) should be returned to the bottom MOSFET source to provide the best gate current return path. Analog ground (GND) should be returned to the ground side of the output capacitors so that the analog circuitry in the controller has an electrically quiet reference and to provide the greatest feedback accuracy. The problem is that the differential voltage capability of the two IC grounds is limited to about 1V for proper operation and so the physical separation between the two grounds must also be minimized. If the grounds are too far apart, fast current transitions in the connection can generate voltage spikes exceeding the 1V capability, resulting in unstable and erratic behavior.

The feedback divider must be close to the IC and be returned to analog ground. Current sense traces must be run parallel and close to each other and to analog ground.

The IC must have a ceramic decoupling capacitor across its supply pins, mounted as close to the device as possible. The small ceramic, noise-filtering capacitors on the current sense lines should also be placed as close to the IC as possible.

**POWER MANAGEMENT**

**Outline Drawing - TSSOP-20**

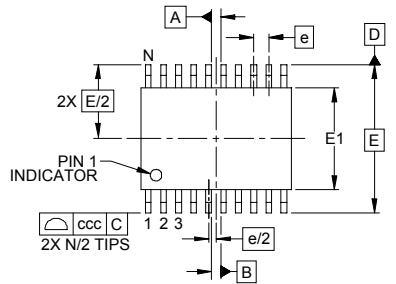

DIM	INCHES			MILLIMETERS		
	MIN	NOM	MAX	MIN	NOM	MAX
A	-	-	.047	-	-	1.20
A1	.002	-	.006	0.05	-	0.15
A2	.031	-	.042	0.80	-	1.05
b	.007	-	.012	0.19	-	0.30
c	.003	-	.007	0.09	-	0.20
D	.251	.255	.259	6.40	6.50	6.60
E1	.169	.173	.177	4.30	4.40	4.50
E	.252 BSC			6.40 BSC		
e	.026 BSC			0.65 BSC		
L	.018	.024	.030	0.45	0.60	0.75
L1	(.039)			(1.0)		
N	20			20		
θ1	0°	-	8°	0°	-	8°
aaa	.004			0.10		
bbb	.004			0.10		
ccc	.008			0.20		

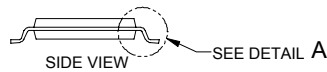
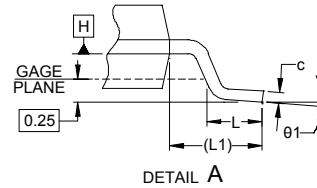
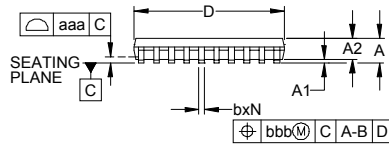

- NOTES:
1. CONTROLLING DIMENSIONS ARE IN MILLIMETERS (ANGLES IN DEGREES).
  2. DATUMS [-A-] AND [-B-] TO BE DETERMINED AT DATUM PLAN[-H-]
  3. DIMENSIONS "E1" AND "D" DO NOT INCLUDE MOLD FLASH, PROTRUSIONS OR GATE BURRS.
  4. REFERENCE JEDEC STD MO-153, VARIATION AC.

**Land Pattern - TSSOP-20**

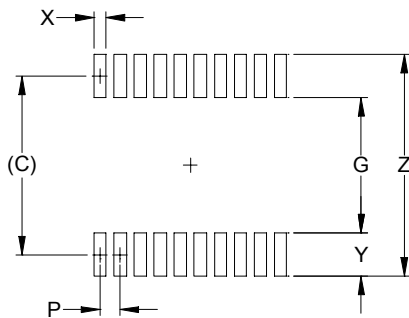

DIM	INCHES	MILLIMETERS
C	(.222)	(5.65)
G	.161	4.10
P	.026	0.65
X	.016	0.40
Y	.061	1.55
Z	.283	7.20

- NOTES:
1. THIS LAND PATTERN IS FOR REFERENCE PURPOSES ONLY. CONSULT YOUR MANUFACTURING GROUP TO ENSURE YOUR COMPANY'S MANUFACTURING GUIDELINES ARE MET.

**POWER MANAGEMENT**

**Outline Drawing - SO-20**

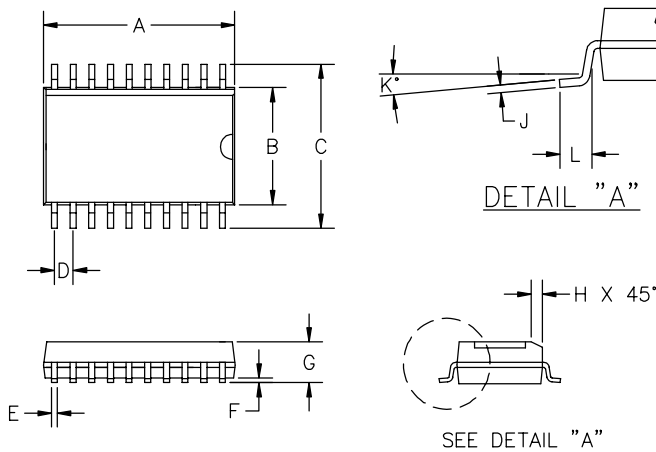

DIM <sup>n</sup>	DIMENSIONS ①				NOTE
	INCHES		MM		
	MIN	MAX	MIN	MAX	
A	.496	.512	12.6	13.0	②
B	.291	.299	7.40	7.60	②
C	.394	.419	10.0	10.65	—
D	.050	BSC	1.27	BSC	—
E	.013	.020	0.33	0.51	—
F	.004	.012	.10	.30	—
G	.092	.104	2.35	2.65	—
H	.010	.030	.25	.75	—
J	.009	.013	.23	.32	—
K	0°	8°	0°	8°	—
L	.016	.050	.40	1.27	—

- ② DIMENSIONS A AND B DO NOT INCLUDE MOLD PROTUSIONS
- ① CONTROLLING DIMENSION : MILLIMETERS.

**Contact Information for Semtech International AG**

<b>Taiwan Branch</b>	Tel: 886-2-2748-3380 Fax: 886-2-2748-3390	<b>Semtech Switzerland GmbH Japan Branch</b>	Tel: 81-3-6408-0950 Fax: 81-3-6408-0951
<b>Korea Branch</b>	Tel: 82-2-527-4377 Fax: 82-2-527-4376	<b>Semtech Limited (U.K.)</b>	Tel: 44-1794-527-600 Fax: 44-1794-527-601
<b>Shanghai Office</b>	Tel: 86-21-6391-0830 Fax: 86-21-6391-0831	<b>Semtech France SARL</b>	Tel: 33-(0)169-28-22-00 Fax: 33-(0)169-28-12-98
Semtech International AG is a wholly-owned subsidiary of Semtech Corporation, which has its headquarters in the U.S.A.		<b>Semtech Germany GmbH</b>	Tel: 49-(0)8161-140-123 Fax: 49-(0)8161-140-124