

POWER MANAGEMENT

Features

- Input voltage range — 2.3V to 5.5V
- 1.2A continuous output current
- 4MHz switching frequency
- Adjustable Output Voltage
 - 0.8V to VIN
- 1% output voltage accuracy
- Adaptive On-Time architecture
- Up to 100% duty cycle
- Up to 96% peak efficiency
- Power Save mode for efficient light load operation
- >90% efficiency 30mA to 75mA
- 1µA shutdown current
- 23µA quiescent current
- Pre-bias startup protection
- Internal or optional external Soft Start
- Device options (contact Semtech Marketing)
 - Automatic output discharge
 - Power Good indicator
 - Internal Soft Start
 - External Programmable Soft Start
 - Forced PWM Operation Input
- 0.75mm x 1.11mm, 6-Bump WLCSP Package
- WEEE and RoHS compliant and halogen-free

Applications

- Automotive
- Smart Phones
- Wearable Electronics
- Tablet PCs
- GPS devices
- Battery powered equipment
- Portable devices

Description

The SC21150 is an ultra high efficiency 1.2A DC/DC buck regulator available in a tiny CSP package. These features make the SC21150 family perfect for small form factor portable applications where long battery life is essential. SC21150 is an Adaptive On-Time 4MHz switching regulator at full load conditions. Under light load conditions it seamlessly transitions into Power Save Mode and reduces switching frequency thus saving energy. High switching frequency operation allows the use of a very small 0.47µH inductor along with small input and output capacitors to minimize overall circuit size. A Forced PWM input allows continuous switching under all load conditions.

The SC21150 is highly configurable with a wide range of factory options including internal Soft Start time, fixed or adjustable output voltage, automatic output discharge, and a Forced PWM input.

The SC21150 is offered in an ultra small WLCSP 6-Bump 0.75mm x 1.11mm package with a bump pitch of 0.35mm. The SC21150 operating temperature range is -40C to +85C.

Typical Application Circuit

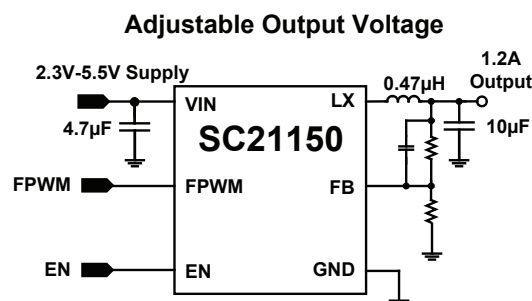

Pin Configuration

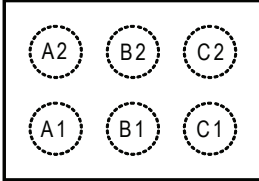

TOP VIEW

0.75x1.11 (mm)

6-Bump WLCSP

Bump Assignments 0.75x1.11mm 6-Bump WLCSP		
Row/Column	1	2
A	GND	VIN
B	LX	FPWM
C	FB	EN

Marking Information

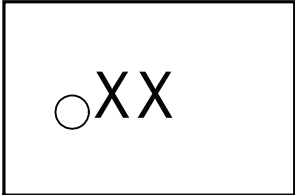

TOP VIEW

0.75x1.11

6-Bump WLCSP

6-Bump WLCSP Marking Diagram
XX = Pin A1 and Marking Code

6-Bump WLCSP Device Code		
Part Number	Output	Marking Code
SC21150ACSTRT	Adj	AZ

Ordering Information

Device ⁽¹⁾⁽²⁾	Options ⁽³⁾			Package
	Output ⁽³⁾	Soft-Start ⁽³⁾	Output Discharge ⁽³⁾	
SC21150ACSTRT	Adjustable	100µs	Automatic	0.75 x 1.11 mm 6-Bump WLCSP
SC21150EVB	Evaluation Board 0.75 x 1.11 mm 6-Bump WLCSP			

Notes:

- (1) Available in tape and reel only. A reel contains 5,000 devices.
- (2) Lead-free packaging only. Device is WEEE and RoHS compliant and halogen-free.
- (3) For other device combinations contact Semtech Marketing for additional options.

The following options can be made available:

VOUT options : fixed or adjustable versions.

Fixed voltages can be specified, from 0.8V to 3.6V in 50mV increments.

Soft-Start options: Fixed internal 100µs, with options for 200µs/400µs/800µs.

Output Discharge options: Automatic Discharge and No Discharge.

Frequency: The default operating frequency is 4MHz with options of 2.2MHz, 3MHz, or 6MHz.

Absolute Maximum Ratings

VIN (V)	-0.3 to +6.0
EN (V)	-0.15 to +(VIN+0.3)
FB, FPWM (V)	-0.3 to +(VIN+0.3)
LX (V).....	-0.3 to +(VIN+0.3)
ESD Protection Level (kV) ⁽¹⁾	4

Recommended Operating Conditions

Input Voltage Range (V)	2.3 to 5.5
Output Voltage Range (V)	0.8 to 3.6
Maximum Continuous Current (A).....	1.2
Junction Temperature Range (°C)	-40 < T _J < +125

Thermal Information

Thermal Resistance Junction to Ambient ⁽²⁾ (°C/W)	
WLCSP package.	100
Maximum Junction Temperature (°C)	+150
Operating Junction Temperature (°C)	-40 to +125
Storage Temperature Range (°C)	-65 to +150
Peak IR Reflow Temperature (10s to 30s) (°C)	+260

Exceeding the above specifications may result in permanent damage to the device or device malfunction. Operation outside of the parameters specified in the Electrical Characteristics section is not recommended.

NOTES:

- (1) Tested according to JEDEC standard JESD22-A114-B.
- (2) Calculated from package in still air, mounted to 3 x 4.5 (in), 4 layer FR4 PCB with thermal vias under the exposed pad per JESD51 standards.

Electrical Characteristics

Unless otherwise noted VIN = 5.0V, CIN = 4.7μF, COU = 10μF, L = 0.47μH, EN = VIN, T_J = -40 to +85°C. Typical values are at T_A = 25°C.

Parameter	Symbol	Conditions	Min	Typ	Max	Units
Input Supply						
Input Supply Voltage Range	VIN		2.3		5.5	V
Shutdown Current	ISD	EN = 0V		0.1		μA
Quiescent Current	IQ	Operating, No Load, Power Save Option		23		μA
Under Voltage Lock Out Threshold	UVLOrise	VIN rising edge	2.05	2.16	2.27	V
Under Voltage Lock Out Hysteresis	UVLOhyst			85		mV
Output Voltage⁽¹⁾						
Feedback Voltage	VFB	Adjustable Vout		0.80		V
Feedback Voltage Tolerance	VFBtol	Adjustable Vout	-2	+/- 1	+2	%
Feedback Input Leakage Current	IFB	Adjustable Vout		1	25	nA

Electrical Characteristics (continued)

Parameter	Symbol	Conditions	Min	Typ	Max	Units
Output Voltage Range	Vout	Adjustable Vout	0.8		VIN	V
Output Voltage Line Regulation	dVline	5.5V > VIN > (Vout + 1), PWM operation		0.17		%/V
Output Voltage Load Regulation	dVload	500mA < ILOAD < 1.2A		-0.13		%/A
Maximum Output Current	IOUT	Continuous current	1.2			A
Soft Start						
Soft Start Time ⁽¹⁾	TSS	FB: from LX rising edge to 95% of final value		100		μs
LX Switching Node						
On Resistance High-side	Rdson_hs	FB = 0V; ILX = 500mA		160		mΩ
On Resistance Low-side	Rdson_ls	FB = VIN; ILX = 500mA		120		mΩ
LX Leakage Current High Side	ILX_hs	FB = VIN = 5.5V; VLX = 0V	-1.5	-0.1		μA
LX Leakage Current Low Side	ILX_ls	FB = 0V; VLX = VIN = 5.5V; Vout Automatic Discharge disabled		0.1	1	μA
LX Pulldown Current ⁽¹⁾	ILX_pd	EN = 0V; VLX = 1V; Vout Automatic Discharge enabled		20		mA
Switching Frequency ⁽¹⁾	Fsw	4MHz option, PWM operation, 500mA load, adjustable output, Vout = 2.5V	3.6	4.0	4.4	MHz
Current Sense						
High Side Current Limit	ILIMhs	Current from VIN to LX	1.5	2.2	3.0	A
Low Side Current Limit	ILIMls	Current from LX to GND		-0.8		A
Zero Cross Detector Threshold	Ithzcpfm	Power Save Mode and DC Test condition		0		mA
Thermal Protection						
Over-Temperature Shutdown	Tts_rise	Rising temperature		160		°C
Over-Temperature Hysteresis	Tts_hyst			10		°C
EN Input						
EN Input High Threshold	VIHen		1.2			V
EN Input Low Threshold	VILen				0.4	V
EN Input High Current	IIHen	VEN = VIN	-1			μA
EN Input Low Current	IILen	VEN = 0V			1	μA

Electrical Characteristics (continued)

Parameter	Symbol	Conditions	Min	Typ	Max	Units
Forced PWM Input⁽¹⁾						
FPWM Input High Threshold	V _{IHFpwm}		1.2			V
FPWM Input Low Threshold	V _{ILFpwm}				0.4	V
FPWM Input High Current	I _{IHFpwm}	FPWM pin = V _{IN}	-1			μA
FPWM Input Low Current	I _{ILFpwm}	FPWM pin = 0V			1	μA

Notes:

(1) The following options can be made available:

V_{OUT} options : fixed or adjustable versions.

Fixed voltage options are as shown in the Ordering Information Table.

Additional fixed voltages can be specified, from 0.8V to 3.6V in 50mV increments.

Soft-Start options: Fixed internal 100μs, with options for 200μs/400μs/800μs.

Output Discharge options: Automatic Discharge and No Discharge.

Frequency: The default operating frequency is 4MHz with options of 2.2MHz, 3MHz, or 6MHz.

Typical Characteristics

Efficiency vs. Load - 5VIN

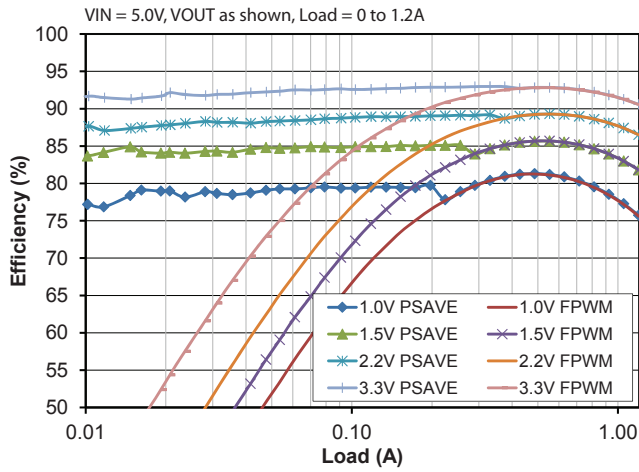

Efficiency vs. Load - 4.2VIN

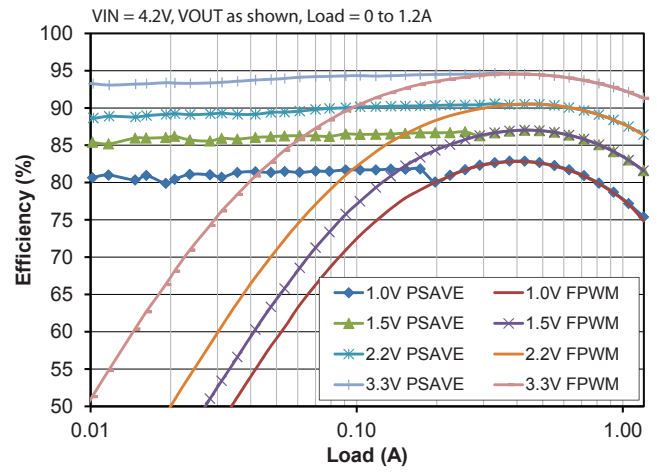

Efficiency vs. Load - 3.3VIN

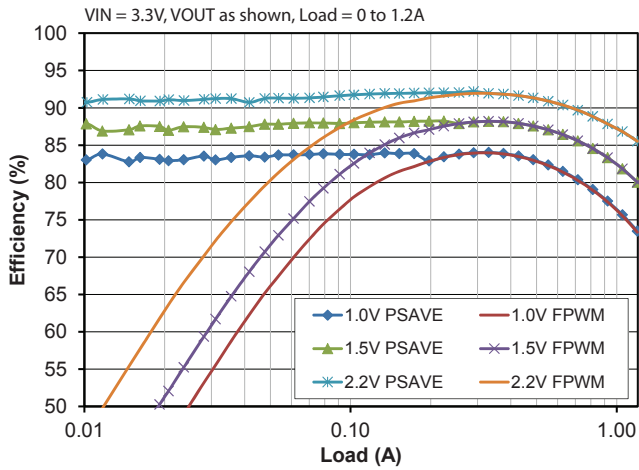

Efficiency vs. Load - 2.3VIN

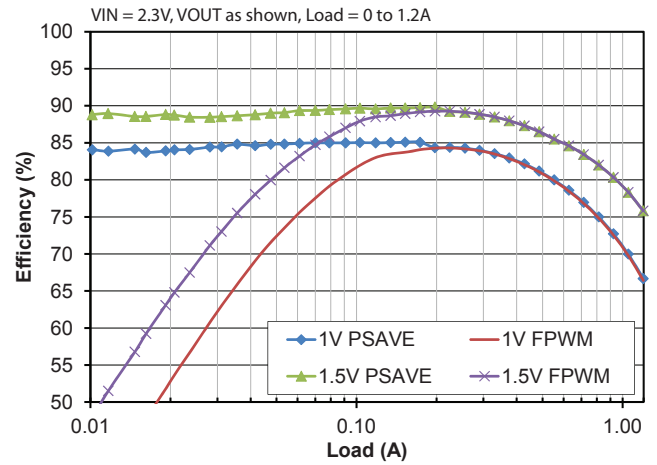

Efficiency vs. Load - VOUT 1.0V

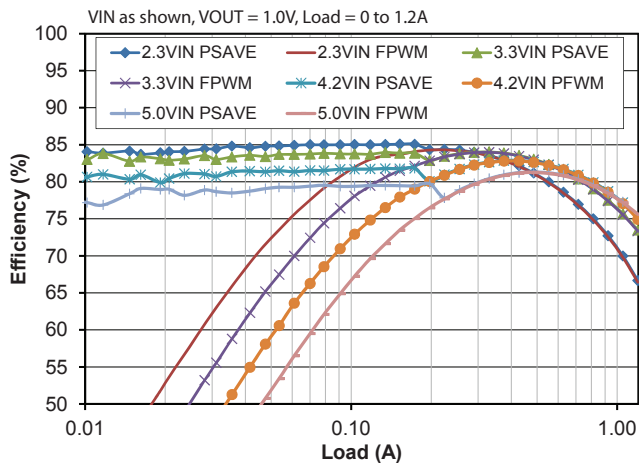

Efficiency vs. Load - VOUT 1.8V

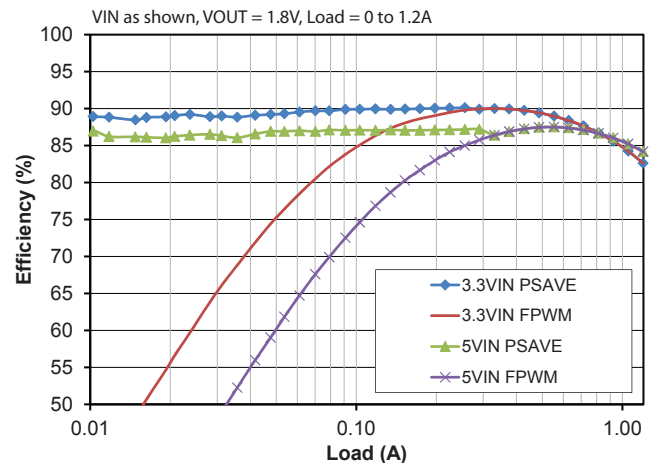

Typical Characteristics

Frequency vs load - 5VIN, FPWM operation

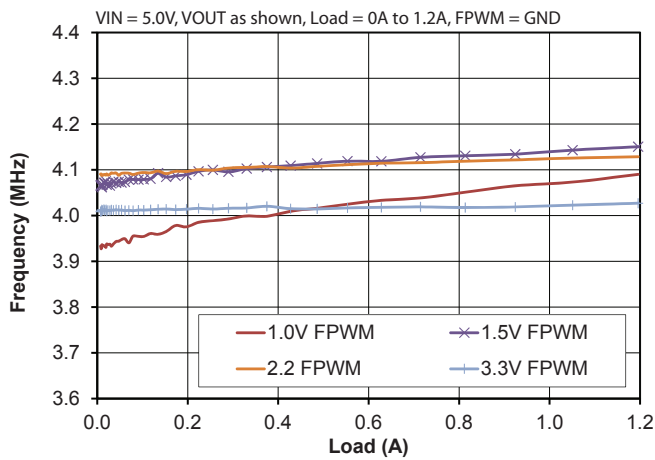

Frequency vs load - 3.3VIN, FPWM operation

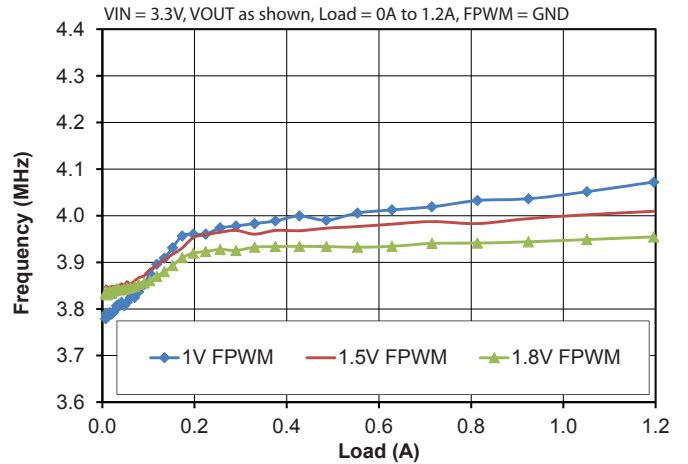

Frequency vs load - 2.3VIN, FPWM operation

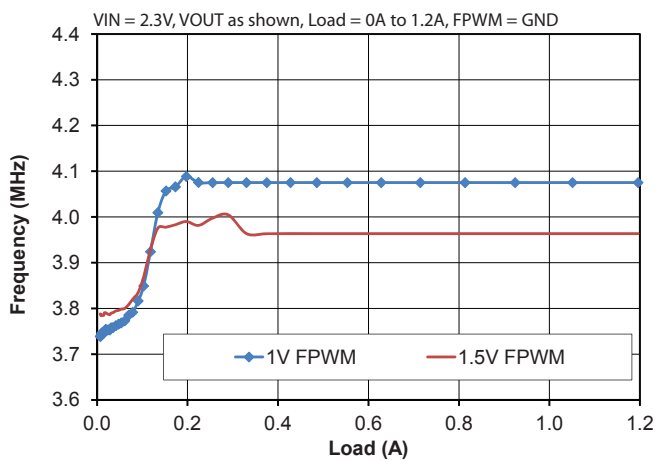

Quiescent Current vs Output Voltage

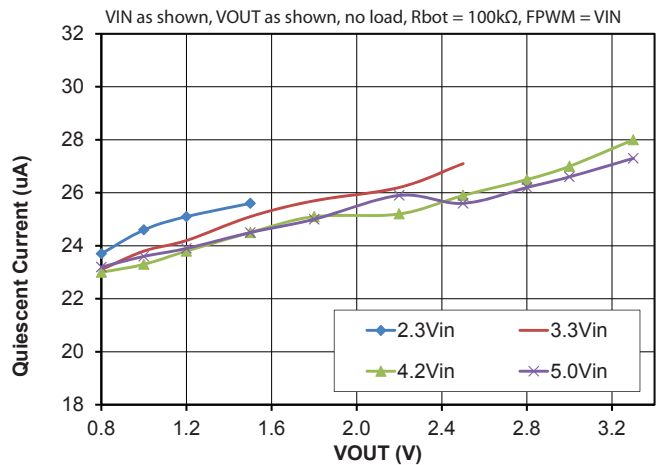

RDS_{ON} vs. Input Voltage

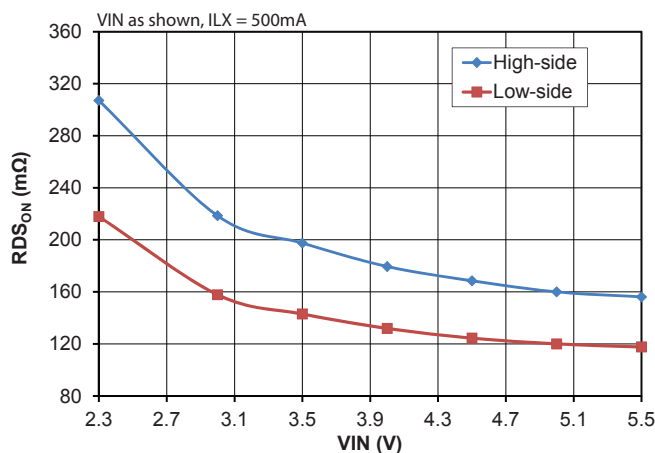

RDS_{ON} vs. Temperature

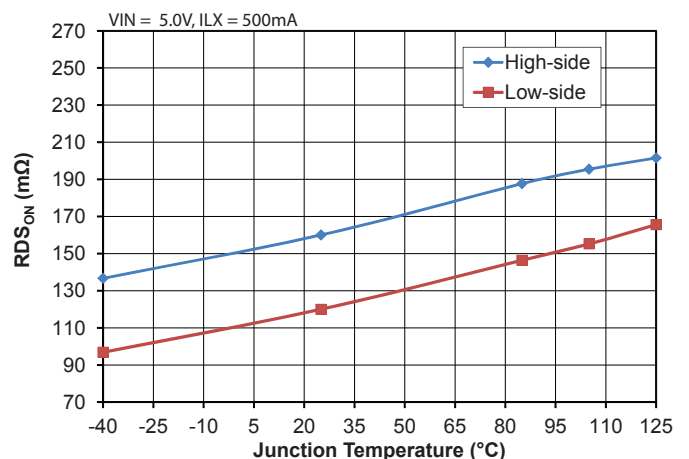

Typical Characteristics (continued)

Power Save Operation — no load

VIN = 5V, VOUT = 3.3V, 0mA load, FPWM = GND

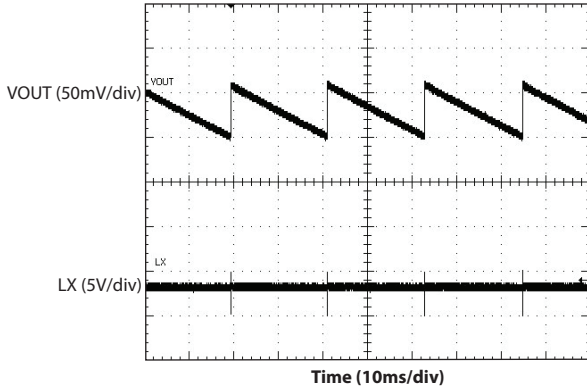

Power Save Operation — 50mA load

VIN = 5V, VOUT = 3.3V, 50mA load, FPWM = GND

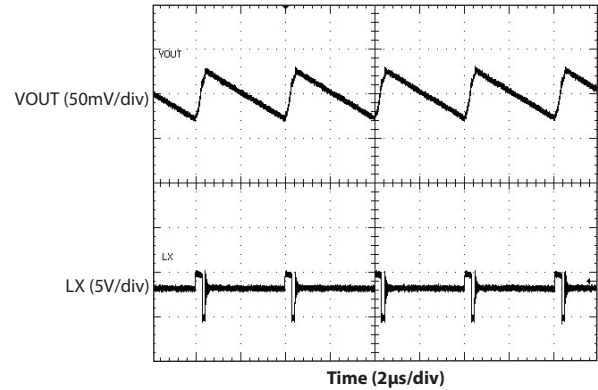

FPWM Operation — no load

VIN = 5V, VOUT = 3.3V, 0mA load, FPWM = VIN

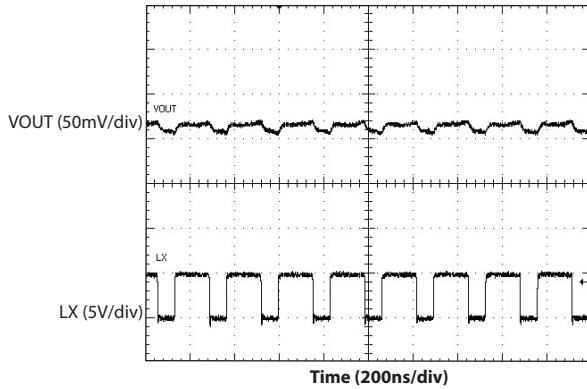

FPWM Operation — 1.2A load

VIN = 5V, VOUT = 3.3V, 1.2A load

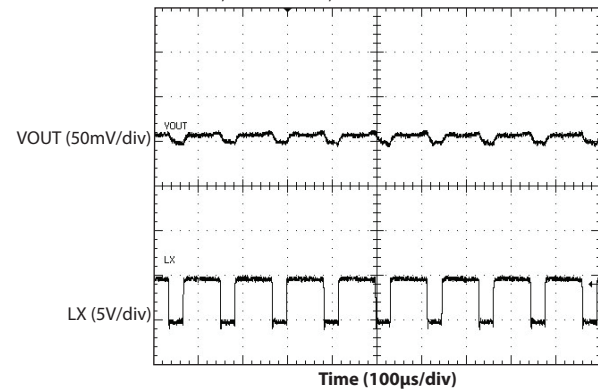

Startup — VIN Ramp

VIN = EN = 2.3V ramp, VOUT = 1.2V, no load

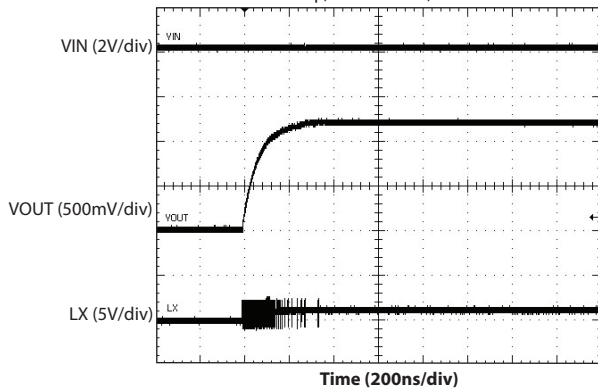

Startup - EN Control

VIN = 5V, VOUT = 1.2V, 1.2A Load

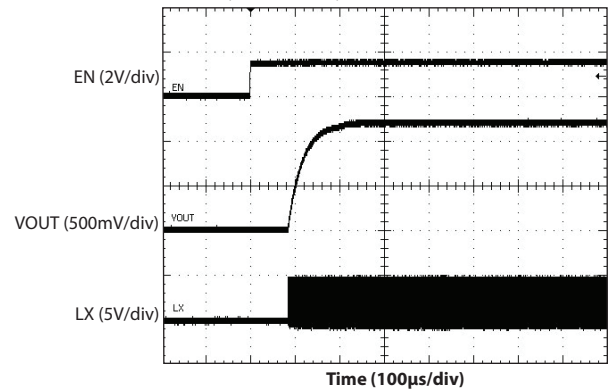

Typical Characteristics (continued)

Load Transient - Power Save PFM to PWM

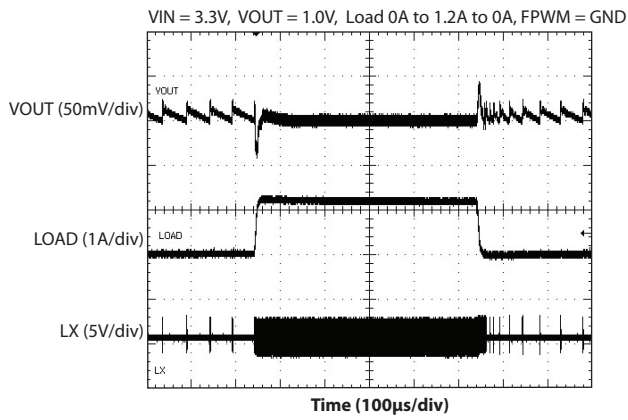

Load Transient - PWM to PWM

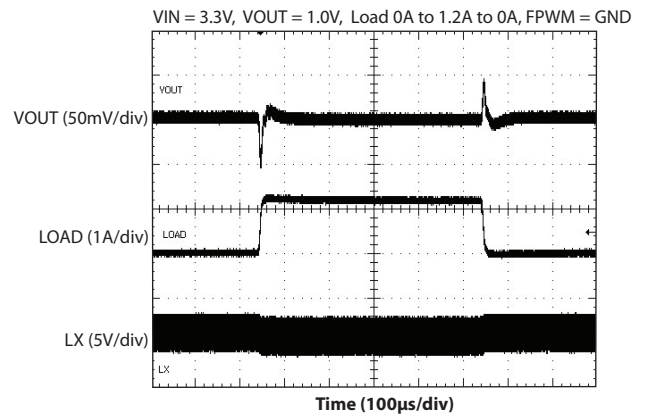

Load Transient - Power Save PFM to PWM

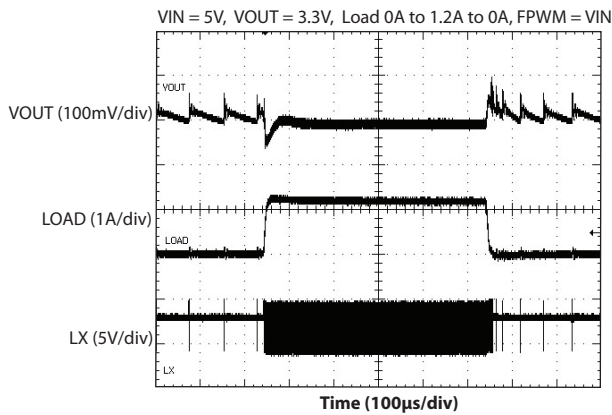

Load Transient - PWM to PWM

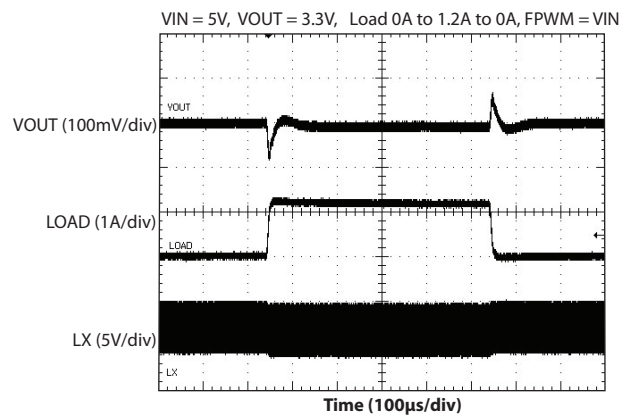

PWM Minimum Off Operation

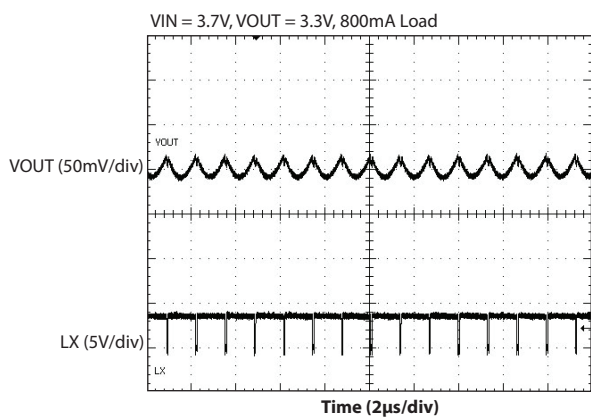

Overcurrent Shutdown and Recovery

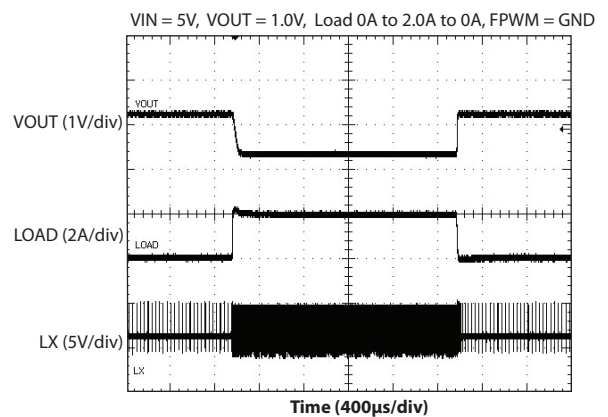

Detailed Application Circuit

Adjustable Output Voltage

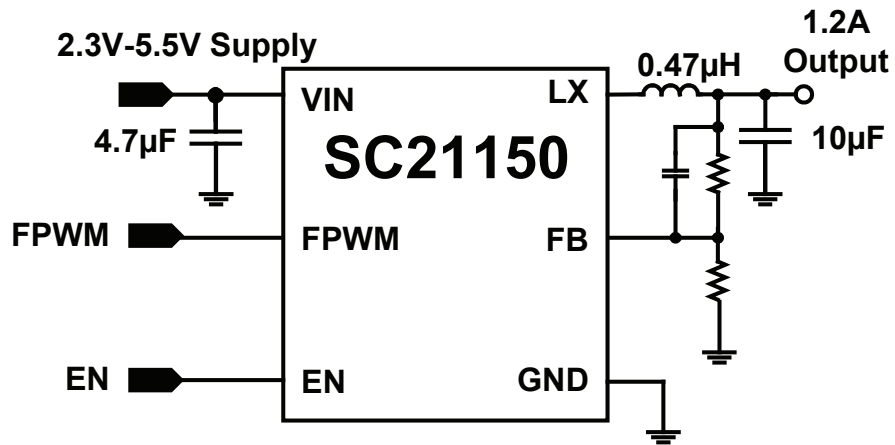

Bump Descriptions - 0.75 x 1.11mm 6-bump WLCSP

Bump	Bump Name	Bump Description
A1	GND	Ground connection.
A2	VIN	Input Supply Voltage for the device and sense point for the input Under Voltage Lock Out.
B1	LX	Switching node connection to inductor.
B2	FPWM	Forced PWM input. A logic low enables the automatic Power Save feature. A logic high disables the Power Save feature to ensure Forced PWM operation.
C1	FB	Feedback input (Output Voltage sense). To adjust the output voltage, connect to the midpoint of a resistor divider between the output voltage and GND.
C2	EN	Enable input. Connect to logic high or VIN to enable the device. Connect to logic low or GND to disable the device.

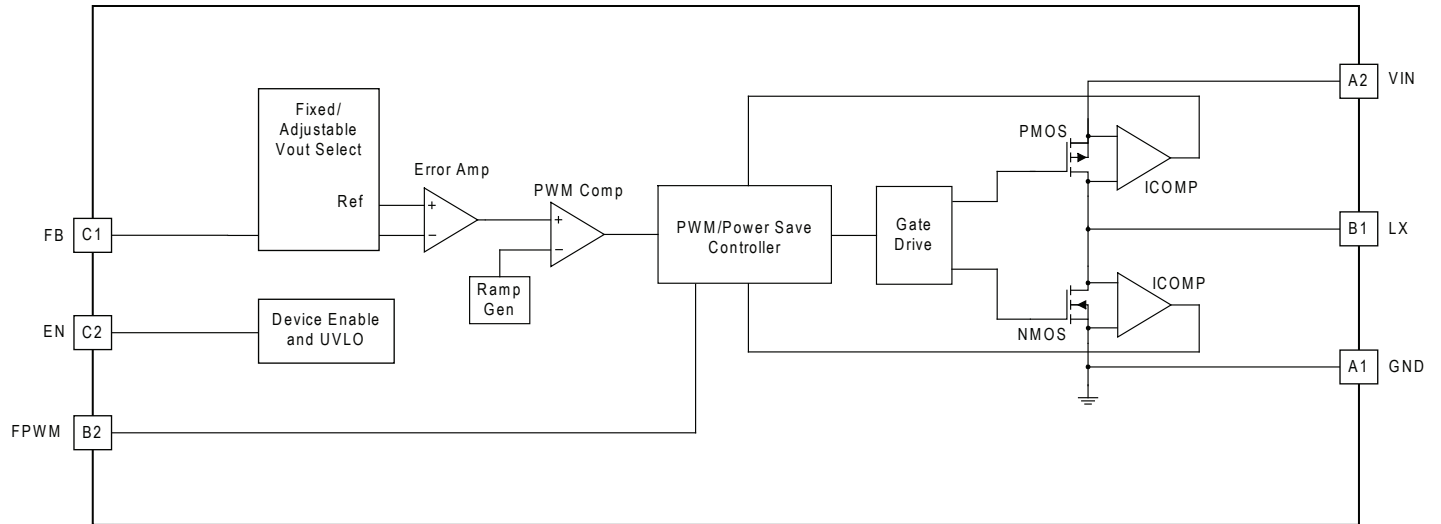
Block Diagram

Applications Information

Synchronous Buck Converter

The SC21150 is a synchronous buck regulator that employs an adaptive on-time architecture to provide fast transient response and very small circuit area. The SC21150 operates over an input voltage range of 2.3 to 5.5V.

Operating Modes

The SC21150 operates in one of four different modes depending on the status of VIN, VOUT, and load.

- PWM Adaptive On-time operation (AOT)
- PWM Minimum Off-time operation (Min Off)
- PFM (Pulse Frequency Modulation for Power Saving)
- Drop-Out operation (LDO mode)

PWM AOT Mode Operation

During PWM AOT operation the controller uses adaptive on-time control. The FB ripple signal is routed to a gain stage and then to the internal comparator and reference which trigger the high-side pulses. The reference includes a compensation ramp which emulates the inductor current to provide stable switching.

AOT operation is used when the low-side pulse-width (off-time) is greater than the minimum 60nsec.

A switching cycle in AOT mode is as follows:

- On-time: the cycle starts with the high-side mosfet turn-on. The pulse width is set by the following formula where f_{sw} is 4MHz:

$$T_{ON} = \frac{V_{OUT}}{V_{INMAX} \times f_{SW}}$$

- Off-time: after the high-side on-time is completed, the low-side mosfet turns on to begin the off-time. The off-time pulse width is set by the internal compensation ramp and under static conditions results in typically 4MHz switching frequency.

Note that the SC21150 enters AOT operation if VIN is less than VOUT/0.88. Also note that connecting the FPWM to a logic high will disable the Power Save feature and lead to constant switching even under light load conditions.

PWM Min Off Operation

The device will enter Minimum Off-time operation (Min Off) when VIN, VOUT, and load conditions force the off-time (time between high-side pulses) to the minimum value, typically 60nsec. This indicates that the controller has reached maximum duty cycle for AOT operation and longer duty cycles are needed.

In Min Off operation the SC21150 uses constant off-time control. As in AOT operation, the FB ripple signal is routed to a gain stage and then to the internal AOT comparator and reference. In Min Off mode, the FB ripple triggers the low-side turn-on. Min Off switching cycle operation is as follows:

- Off-time: The low-side mosfet is on for a fixed Minimum Off time of 60nsec. This draws current from the output capacitor through the inductor via the LX pin and causes the output to fall.
- On-time: after the Min Off time of 60nsec has elapsed, the high-side mosfet turns on. This helps recharge the output capacitor and bring the output voltage up. The on-time pulse width is determined by the internal compensation ramp.

Drop-out Operation

When operating in Min Off mode, the off-time is constant and the high-side on-time varies in order to regulate the output. For cases where VIN is near VOUT, the high-side will remain on continually with 100% duty cycle. The output voltage will then be limited by the input voltage, high-side RDS_{ON} and inductor DCR as shown in the following equation:

$$V_{OUT} = V_{IN} - I_{LOAD} \times (R_{DS_{ON}} + DCR)$$

Note that RDS_{ON} is a function of input voltage and temperature. Inductor DC resistance also increases with temperature.

Applications Information (continued)

Power Save (PFM) Operation

PFM operation is enabled when the FPWM input is a logic low. Under this condition, the IC automatically reduces switching frequency under light load conditions to conserve power. In PFM operation, the FB ripple signal is routed to a gain stage and compared to an internal reference. A switching cycle is as follows.

- **On-time:** The high-side mosfet turns on, as triggered by the FB signal falling to the internal reference. The high-side stays on for a predetermined time based on VIN and VOUT, then turns off.
- **Off-time:** the low-side mosfet turns on. Inductor current is monitored via the low-side switch. When the current falls to zero, the low-side mosfet turns off.
- **Dead-time:** both mosfets are off. If the FB signal is higher than the internal reference, both mosfets remain off. During the dead-time the load current is supplied by the output capacitor, causing the output and the FB signal to fall. When the FB signal falls to the 800mV threshold, the next high-side pulse begins.

As load current increases, the dead-time between pulses reduces. On any cycle, if the minimum off-time (60nsec) has elapsed and the FB signal is calling for another high-side on-time, the controller exits PFM and enters PWM operation.

Once the controller is in PWM operation, the inductor current must go below zero (go negative) for 16 switching cycles before the controller will return to PFM operation.

Soft start

The SC21150 contains an internal soft start to reduce inrush current during start-up. During start-up, the FB signal is compared to an internal ramp, providing a gradual ramp on VOUT. The timing to move VOUT from 0V to 95% of final value is typically 100usec. Optional soft start times of 200usec, 400usec, and 800usec can be provided.

Pre-bias Start-up

During start-up, the low-side mosfet turns off if the inductor current falls negative (into the LX pin) on any cycle. This prevents discharge of the output capacitor during the soft-start cycle. Note that if the output is loaded during a Pre-Bias start-up, the output voltage may fall until the internal Soft-start ramp rises above the voltage seen at the FB pin.

VIN Under-Voltage Lockout

The SC21150 includes an under-voltage lockout (UVLO) to inhibit switching until the input voltage exceeds 2.16V. The VIN UVLO threshold has 85mV hysteresis to prevent chatter during start-up.

EN Input

The EN input is a logic level input. When EN is set to logic high, the SC21150 goes through an internal reset to prepare for operation. The soft-start ramp and mosfet switching begin typically 50µsec after EN is driven high.

When EN is low (grounded), the power mosfets are off and the SC21150 is its lowest power state. The automatic discharge mosfet connected to LX is on to discharge the output before the next start-up cycle.

FPWM Input

The FPWM input is a logic level input that enables or disables the Power Save feature. Connect the FPWM input to a logic low or GND to enable Power Save operation. To disable Power Save operation and provide continuous switching at all loads, connect the FPWM input to a logic high or VIN.

Automatic Discharge

When the EN pin is pulled low (grounded), the power mosfets are tri-stated and the LX pin is connected to GND through an internal mosfet to discharge the output capacitors. Typical mosfet RDS_{ON} is 40 ohms at 5V and 25°C. Note that RDS_{ON} is a function of both VIN and temperature.

The automatic discharge feature can optionally be disabled from the device.

Applications Information (continued)

Over-current Protection

The SC21150 provides overload protection through pulse by pulse current limiting. During the high-side on-time, the high-side switches off if the inductor current exceeds 2.2A typically. The low-side turns on briefly, followed by the next high-side on-time. Switching continues while the output overload exists. When the overload is removed, the SC21150 will resume normal operation. If the overload causes high junction temperature, the SC21150 will go into Over-temperature protection.

Over-temperature Protection

The SC21150 will shut down if the junction temperature exceeds typically 160 °C. The device will automatically restart after the junction temperature has dropped typically 10 °C.

Component Selection

The SC21150 is optimized for use with components as shown in the Detailed Applications Circuit, page 11.

Inductor: the inductor should be 0.47uH and capable of supporting a minimum current of 1.2A.

Input capacitor: ceramic capacitor, minimum 4.7uF, X5R or X7R or better dielectric.

Output capacitor: ceramic capacitor, minimum 10uF, X5R or X7R or better dielectric.

Note when operating in Min Off mode, higher output capacitance may needed to reduce output ripple when VIN approaches VOUT.

The FB components provide output voltage sensing and feedback compensation to regulate the output. The output voltage is programmed using two resistor along with a compensation capacitor.

The FB regulation setpoint is 800mV. The output voltage can be calculated as shown.

$$V_{OUT} = 0.8 \times \left(1 + \frac{R_{top}}{R_{bot}} \right)$$

The FB resistor values can be calculated as shown. It is recommended to use 100kΩ for Rbot to minimize power loss in the FB network.

$$R_{top} = \frac{(V_{OUT} - 0.8V) \times R_{bot}}{0.8V}$$

The optimum value for Ctop is 22pF.

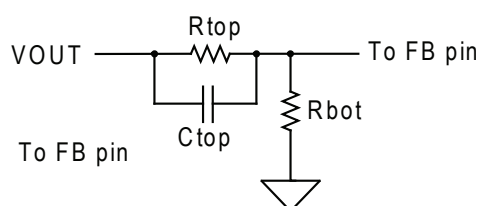

PCB Layout Guidelines

An optimum layout for the SC21150 is shown below. When doing the PCB layout the following guidelines should be used:

The input capacitor must be located as close as possible to the IC and directly connected to pins A2 (VIN) and A1 (GND).

The LX trace from pin B1 to the inductor should be as short as possible, and wide to reduce IR loss and improve heat dissipation.

The output capacitor should be close to the inductor. The feedback components (R_{top}, C_{top}, R_{bot}, for adjustable V_{OUT}) should be located as close as possible to the FB pin. For the ground connection to R_{bot}, use a via to a ground plane and place another via near the A1 (GND) pin of the IC.

The FB trace should be short and not routed near noise signals. Do not route the FB trace under the inductor; the high impedance of the FB circuit can pick up noise from the inductor's magnetic field.

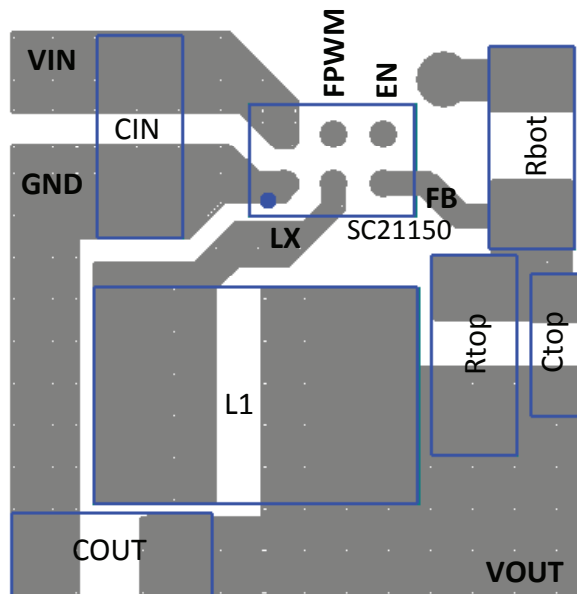

SC21150 PCB Layout

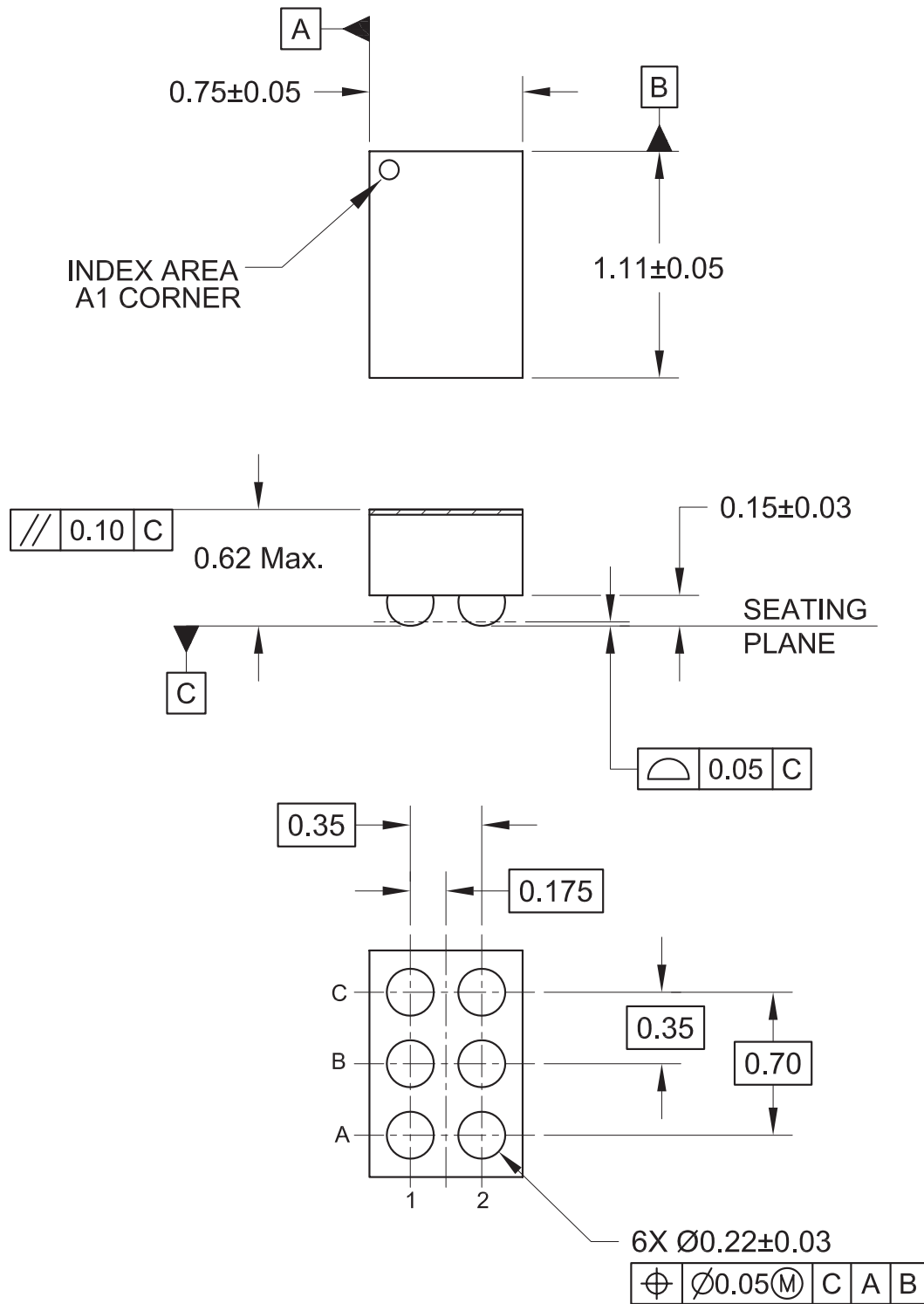
Outline Drawing — 0.75 x 1.11mm 6-Bump WLCSP

NOTES:

1. CONTROLLING DIMENSIONS ARE IN MILLIMETERS

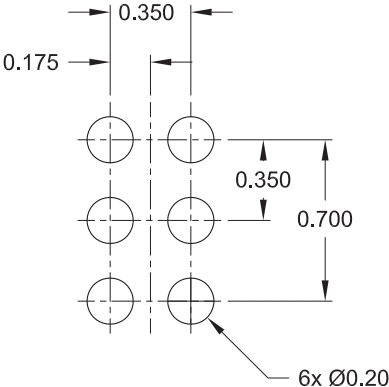
Land Pattern — 0.75x1.11 6-Bump WLCSP



- NOTES:
- 1. CONTROLLING DIMENSIONS ARE IN MILLIMETERS
 - 2. THIS LAND PATTERN IS FOR REFERENCE PURPOSES ONLY. CONSULT YOUR MANUFACTURING GROUP TO ENSURE YOUR COMPANY'S MANUFACTURING GUIDELINES ARE MET.



©Semtech 2016

All rights reserved. Reproduction in whole or in part is prohibited without the prior written consent of the copyright owner. The information presented in this document does not form part of any quotation or contract, is believed to be accurate and reliable and may be changed without notice. No liability will be accepted by the publisher for any consequence of its use. Publication thereof does not convey nor imply any license under patent or other industrial or intellectual property rights. Semtech assumes no responsibility or liability whatsoever for any failure or unexpected operation resulting from misuse, neglect improper installation, repair or improper handling or unusual physical or electrical stress including, but not limited to, exposure to parameters beyond the specified maximum ratings or operation outside the specified range.

SEMTECH PRODUCTS ARE NOT DESIGNED, INTENDED, AUTHORIZED OR WARRANTED TO BE SUITABLE FOR USE IN LIFE-SUPPORT APPLICATIONS, DEVICES OR SYSTEMS OR OTHER CRITICAL APPLICATIONS. INCLUSION OF SEMTECH PRODUCTS IN SUCH APPLICATIONS IS UNDERSTOOD TO BE UNDERTAKEN SOLELY AT THE CUSTOMER'S OWN RISK. Should a customer purchase or use Semtech products for any such unauthorized application, the customer shall indemnify and hold Semtech and its officers, employees, subsidiaries, affiliates, and distributors harmless against all claims, costs damages and attorney fees which could arise.

Notice: All referenced brands, product names, service names and trademarks are the property of their respective owners.

Contact Information

Semtech Corporation
Power Management Products Division
200 Flynn Road, Camarillo, CA 93012
Phone: (805) 498-2111 Fax: (805) 498-3804

www.semtech.com