

REV.	ECN. NO.	NAME	DATE

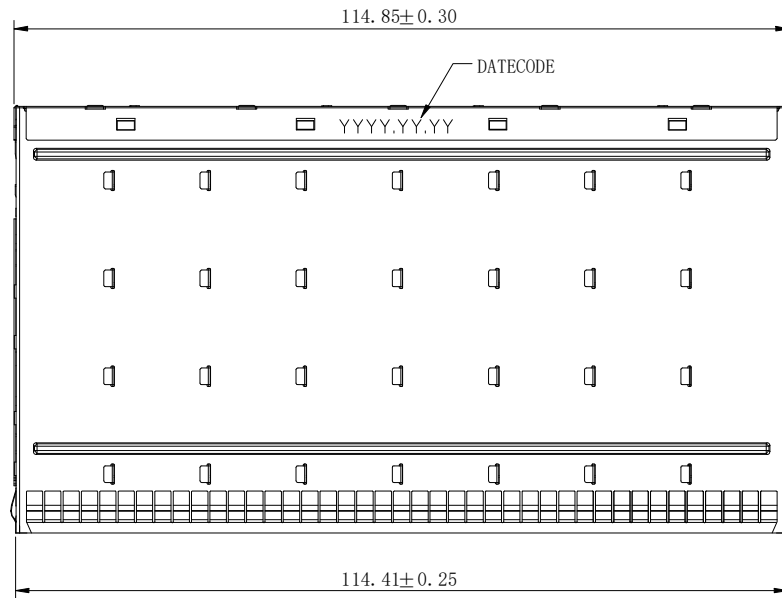

NOTE:

MATERIAL:

1. CONTACT: PHOSPHOR BRONZE.
2. CONNECTOR HOUSING: LCP UL 94V-0. COLOR BLACK.
3. MOULDED INSERT: HIGH TEMPERATURE PLASTIC UL 94V-0. COLOR:BLACK.
4. CAGE: COPPER ALLOY.
5. LIGHT PIPES: POLYCARBONATE. UL 94V-0. COLOR:CLEAR
6. LIGHT PIPE HOUSING: PBT UL 94V-0 COLOR:BLACK.
7. EMI CLIP: COPPER ALLOY.

PLATED:

1. CONTACT MATING AREA : PLATING GOLD 0.76 MICROMETERS MINIMUM OVER 1.27 MICROMETERS MINIMUM NICKEL.
2. CONTACT NEEDLE EYE 1.27 MICROMETERS MINIMUM MATTE TIN OVER 1.27 MICROMETERS MINIMUM NICKEL.

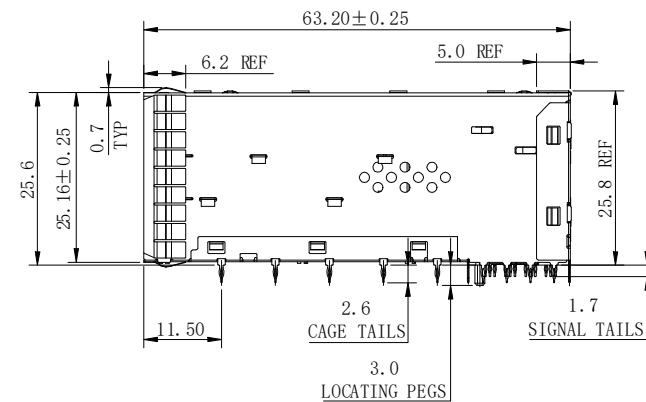
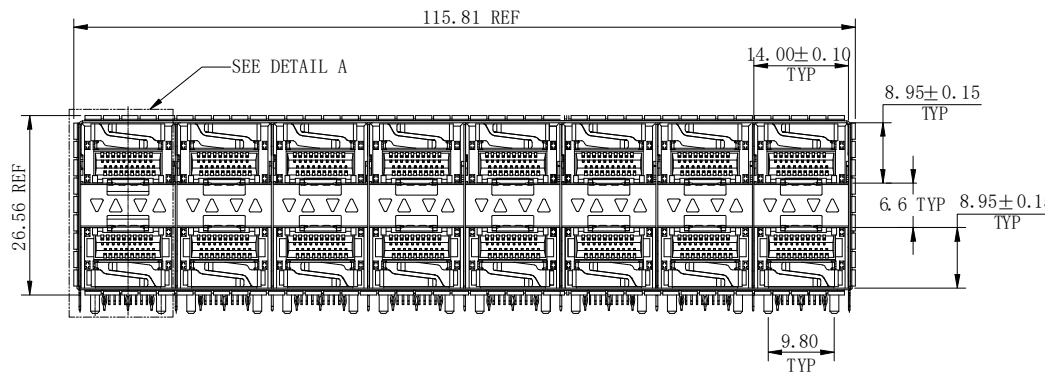

RoHS Compliant

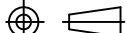
TOLERANCE UNSPECIFIED		 VITALCON a vital connector company		FOR YOUR VITAL CONNECTION			
.0	± 0.38						
.00	± 0.25	TITLE: SFP28 2*8 CONN					
.000	± 0.10	DRAWN BY:	BECKER	PART NO:	SC281XX	REV: A	
ANGLE	$\pm 3.00^\circ$	CHECKED BY:	VTA	SIZE: A4	UNIT:mm	SHEET:10F4	FCN: A6
MANUFACTURING COPY		APPROVED BY:	QPF	PROJECTION		http://www.vitalconn.com	

REV.	ECN. NO.	NAME	DATE

LIGHT PIPE CONFIGURATION
DETAIL B SCALE 2:1

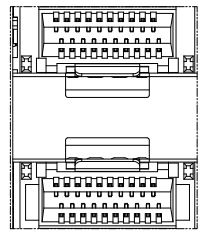

TYPE1_NONE LIGHT PIPE
SC28101

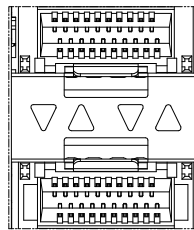

TYPE2_4 LIGHT PIPE
SC28102

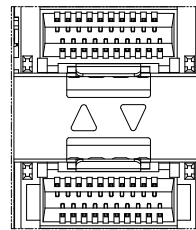

TYPE3_INNER LIGHT PIPE
SC28103

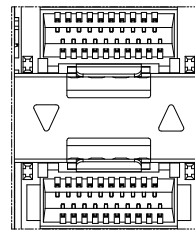

TYPE4_OUTER LIGHT PIPE
SC28104

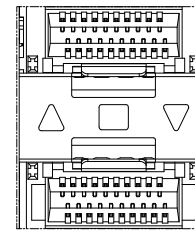

TYPE6_3 LIGHT PIPE
SC28105

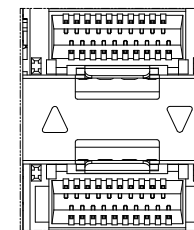

TYPE7_2 OUTER LIGHT PIPE
SC28106

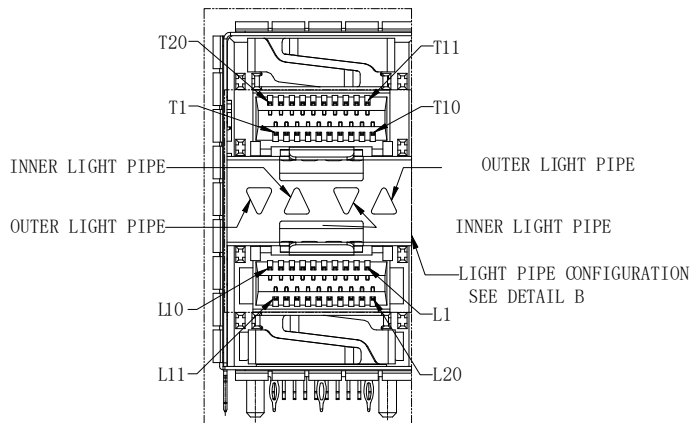

DETAIL A
SCALE 2:1

RoHS Compliant

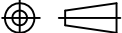
TOLERANCE UNSPECIFIED		 a vital connector company		FOR YOUR VITAL CONNECTION	
.0	± 0.38			TITLE: SFP28 2*8 CONN	
.00	± 0.25	DRAWN BY: BECKER		PART NO: SC281XX	REV: A
.000	± 0.10	CHECKED BY: VTA		SIZE: A4	UNIT:mm
ANGLE	± 3.00°	APPROVED BY: QPF		PROJECTION	SHEET:20F4
MANUFACTURING COPY					http://www.vitalconn.com

REV.	ECN. NO.	NAME	DATE

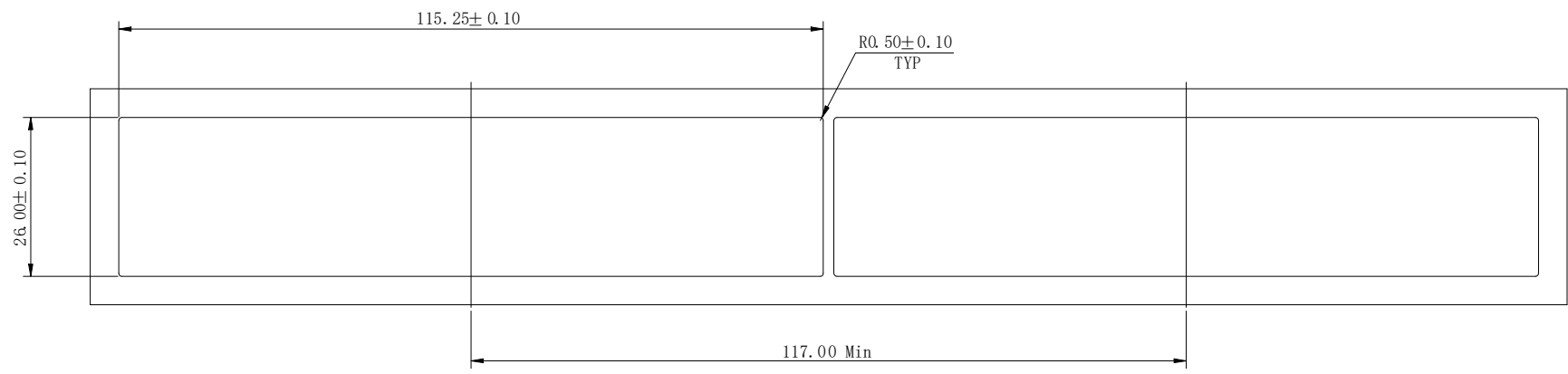

BEZEL CUT-OUT CENTER SPACING DETAIL
BEZEL THICKNESS: 0.8-2.6

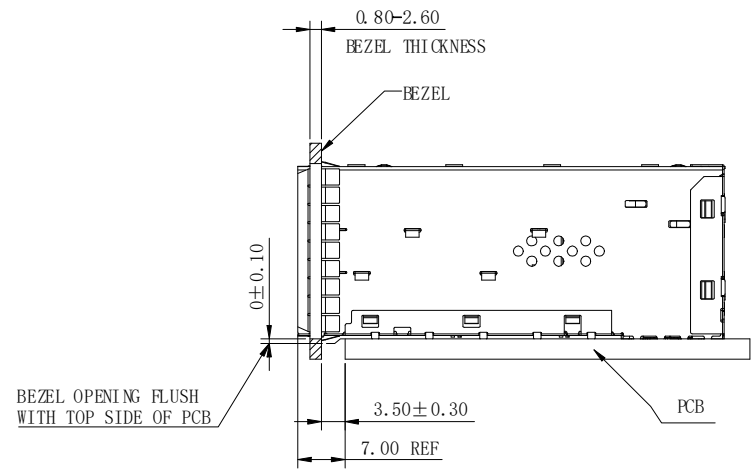

RoHS Compliant

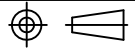
TOLERANCE UNSPECIFIED		 VITALCON a vital connector company		FOR YOUR VITAL CONNECTION	
.0	± 0.38			TITLE: SFP28 2*8 CONN	
.00	± 0.25	DRAWN BY: BECKER		PART NO: SC281XX	
.000	± 0.10	CHECKED BY: VTA		SIZE: A4	
ANGLE	± 3.00°	APPROVED BY: QPF		UNIT:mm	
MANUFACTURING COPY		PROJECTION		SHEET:30F4	
				REV: A	
				FCN: A6	
				 http://www.vitalconn.com	

REV.	ECN. NO.	NAME	DATE

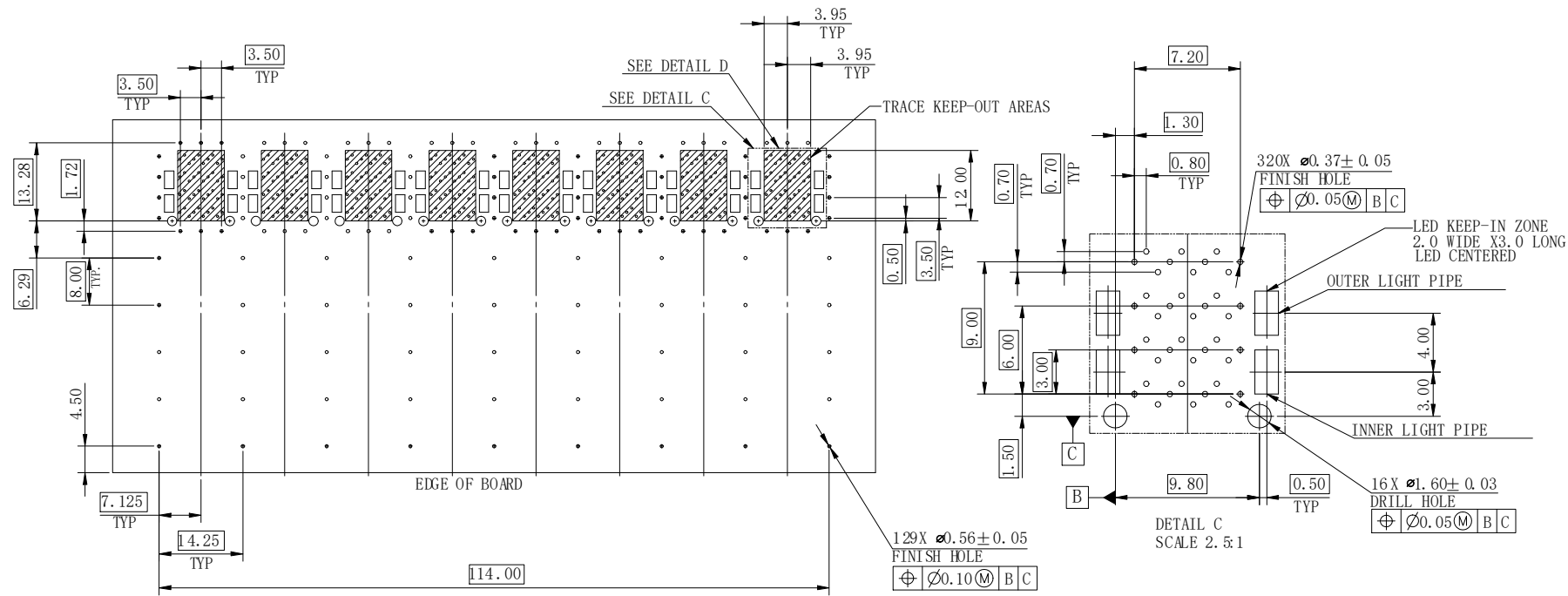

RECOMMENDED PCB LAYOUT—COMPONENT SIDE
RECOMMENDED PCB THICKNESS—2.63mm

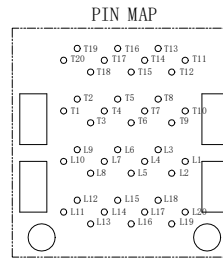

DETAIL D
SCALE 2.5:1

RoHS Compliant

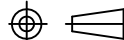
TOLERANCE UNSPECIFIED		 VITALCON <small>a vital connector company</small>		FOR YOUR VITAL CONNECTION							
.0	± 0.38			TITLE: SFP28 2*8 CONN							
.00	± 0.25										
.000	± 0.10										
ANGLE	± 3.00°										
MANUFACTURING COPY		DRAWN BY: BECKER		PART NO: SC281XX		REV: A					
		CHECKED BY: VTA		SIZE: A4		UNIT:mm		SHEET:4OF4		FCN: A6	
		APPROVED BY: QPF		PROJECTION				http://www.vitalconn.com			