

SANYO	No.931D	2SC2999
		NPN Epitaxial Planar Silicon Transistor

HF Amp Applications

Features

- FBET series.
- Very small-sized package permitting sets to be small-sized and slim.
- High f_T ($f_T=750\text{MHz}$ typ.) and small c_{re} ($c_{re}=0.6\text{pF}$ typ.)

Absolute Maximum Ratings at $T_a=25^\circ\text{C}$

			unit
Collector to Base Voltage	V_{CB0}	25	V
Collector to Emitter Voltage	V_{CE0}	20	V
Emitter to Base Voltage	V_{EB0}	3	V
Collector Current	I_C	30	mA
Collector Dissipation	P_C	150	mW
Junction Temperature	T_j	125	$^\circ\text{C}$
Storage Temperature	T_{stg}	-40 to +125	$^\circ\text{C}$

Electrical Characteristics at $T_a=25^\circ\text{C}$

			min	typ	max	unit
Collector Cutoff Current	I_{CBO}	$V_{CB}=10\text{V}, I_E=0$			0.1	μA
Emitter Cutoff Current	I_{EBO}	$V_{EB}=3\text{V}, I_C=0$			0.1	μA
DC Current Gain	h_{FE}	$V_{CE}=6\text{V}, I_C=1\text{mA}$	40*		200*	
Gain-Bandwidth Product	f_T	$V_{CE}=6\text{V}, I_C=4\text{mA}$	450	750		MHz
Reverse Transfer Capacitance	c_{re}	$V_{CB}=6\text{V}, f=1\text{MHz}$	0.6	0.9		pF
Base to Collector Time Constant	$r_{bb}'C_c$	$V_{CB}=6\text{V}, I_C=1\text{mA}, f=31.9\text{MHz}$			19	ps
Noise Figure	NF	$V_{CE}=6\text{V}, I_C=1\text{mA}, f=100\text{MHz}$	2.2			dB
Power Gain	PG	$V_{CE}=6\text{V}, I_C=1\text{mA}, f=100\text{MHz}$	28			dB

*: The 2SC2999 is classified as follows according to h_{FE} at 1mA.

40 C 80	60 D 120	100 E 200
---------	----------	-----------

NF, PG Test Circuit

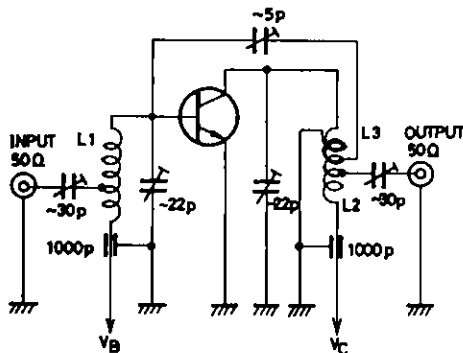

- L1: 1mm ϕ plated wire, 10mm ϕ 5T, pitch: 15mm, tapped at 2T from base side.
 - L2: 1mm ϕ plated wire, 10mm ϕ 7T, pitch 10mm, patted at 2T from V_C side.
 - L3: 1mm ϕ enameled wire, 10mm ϕ 3T, pitch 10mm.
- Unit(Capacitance : F)

Package Dimensions 2033
(unit: mm)

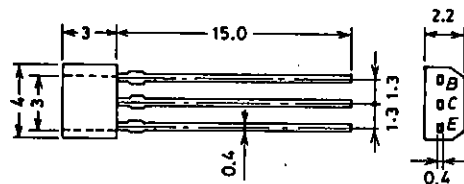

B: Base
C: Collector
E: Emitter

SANYO: SPA

SANYO Electric Co., Ltd. Semiconductor Business Headquarters
TOKYO OFFICE Tokyo Bldg., 1-10, 1 Chome, Ueno, Taito-ku, TOKYO, 110 JAPAN

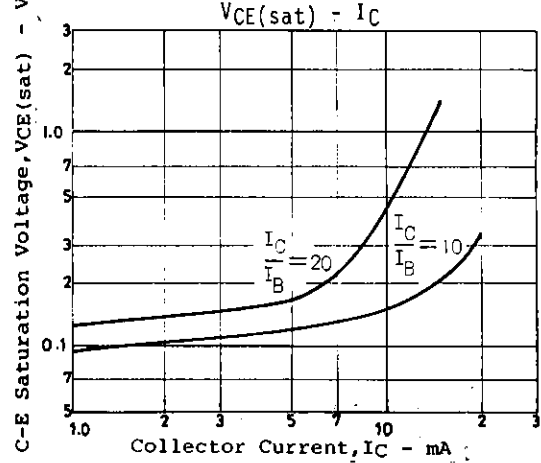
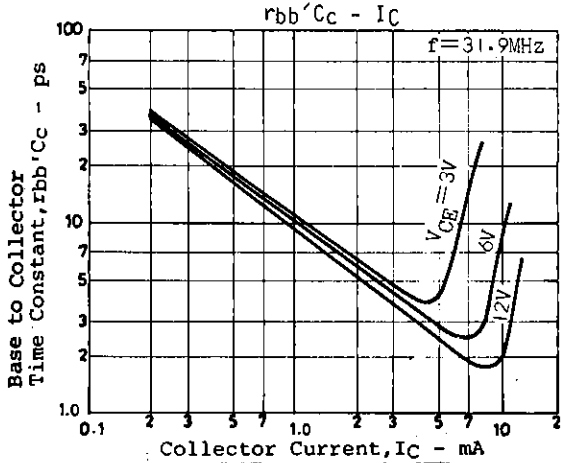
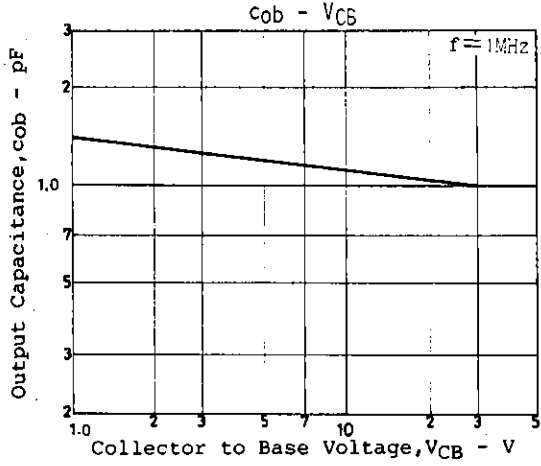
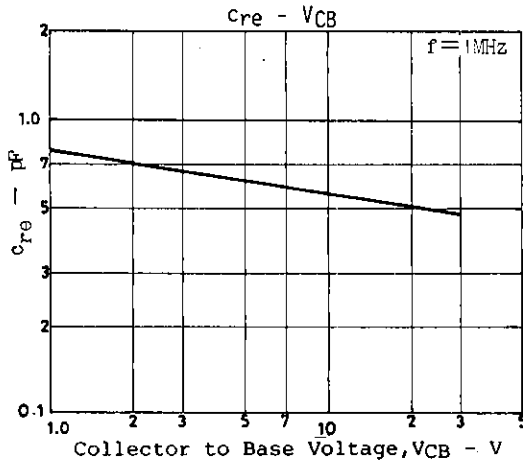
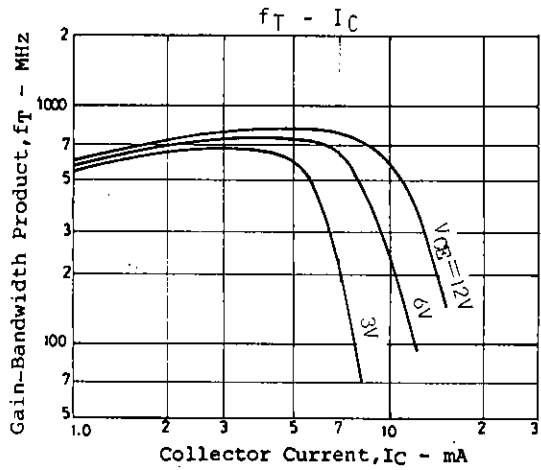
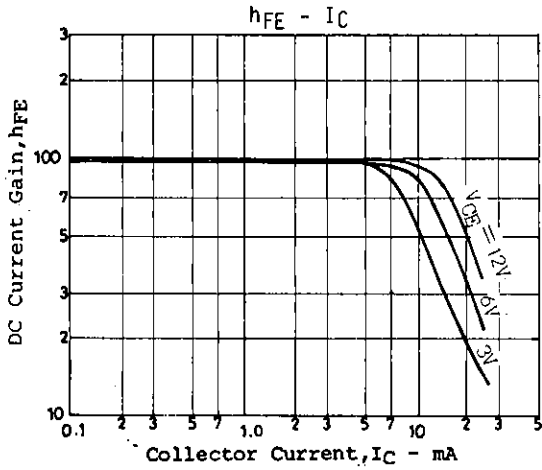
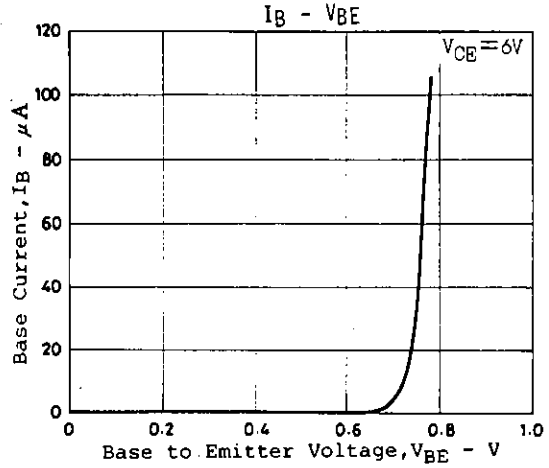
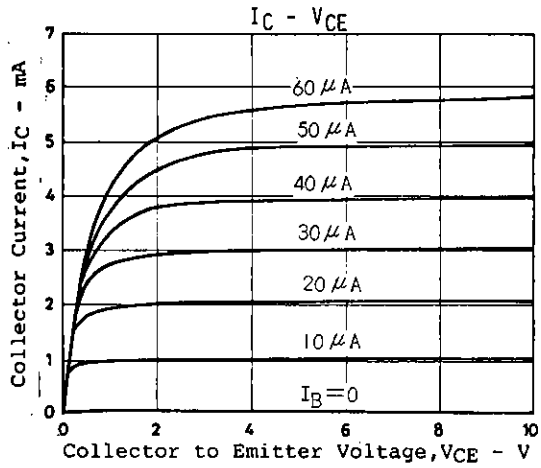

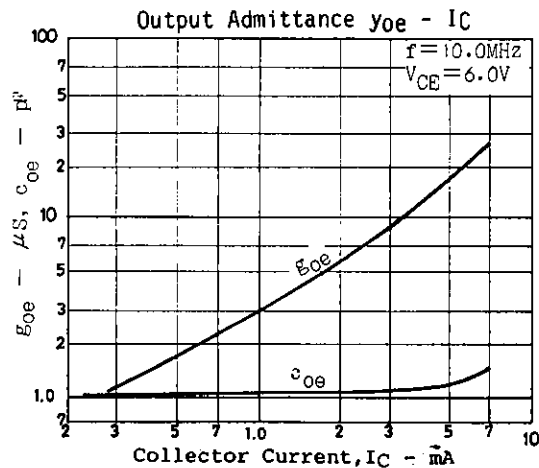
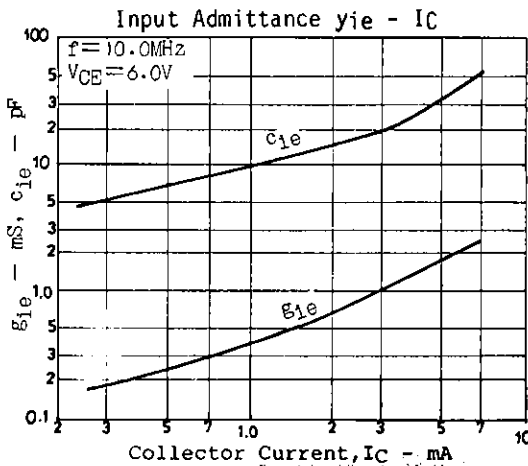
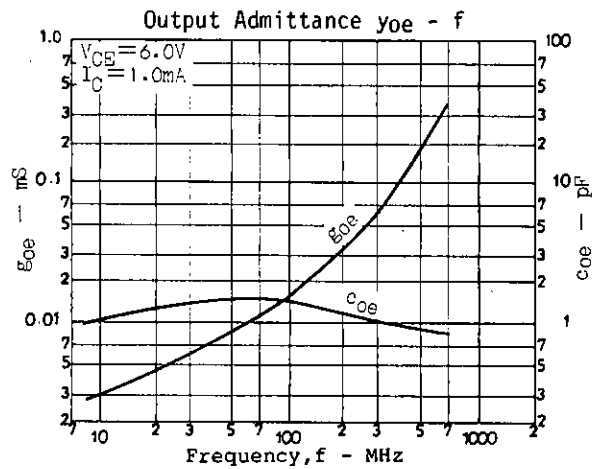
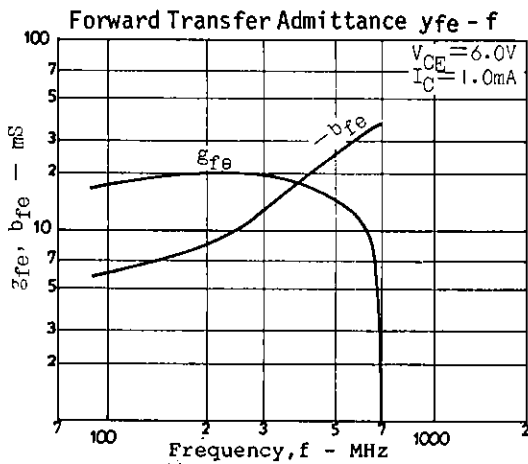
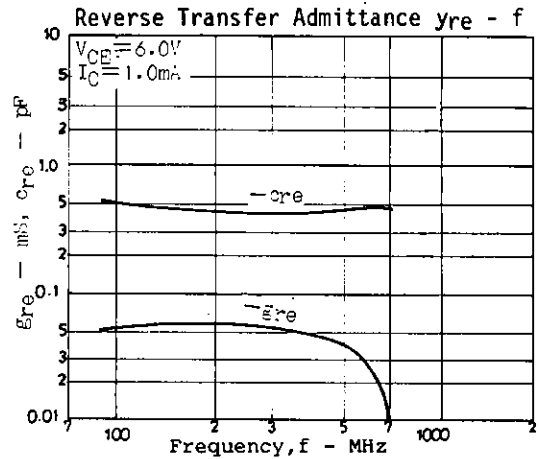
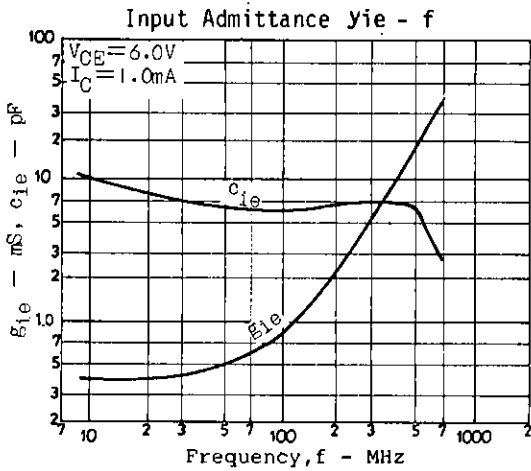
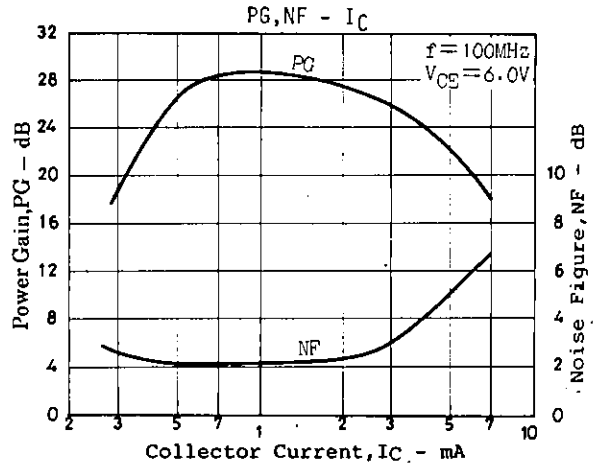
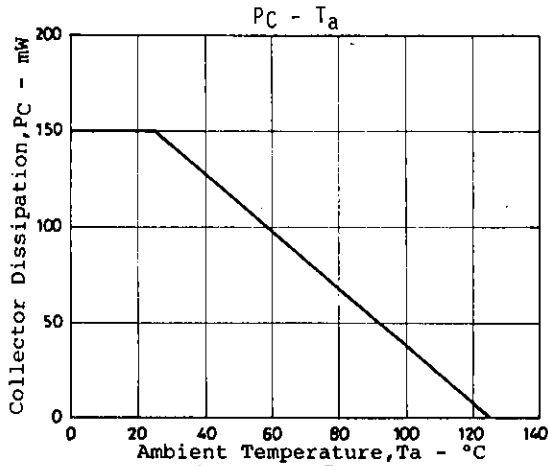

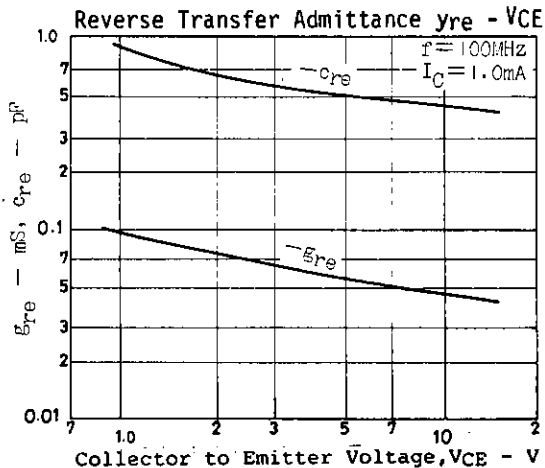
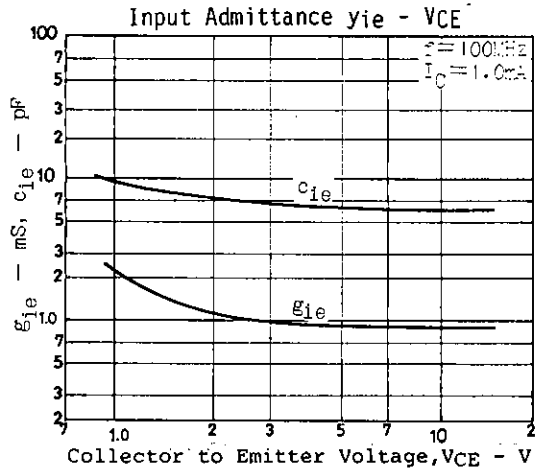
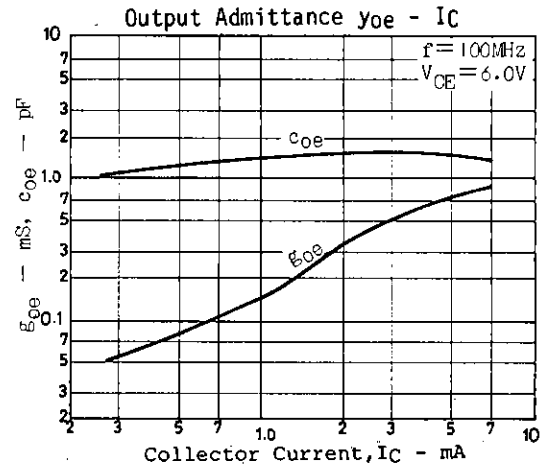
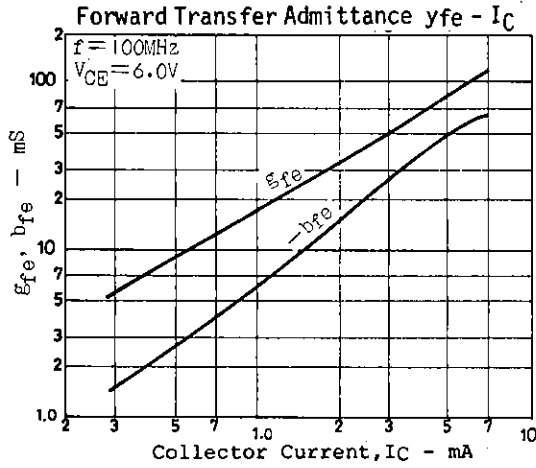
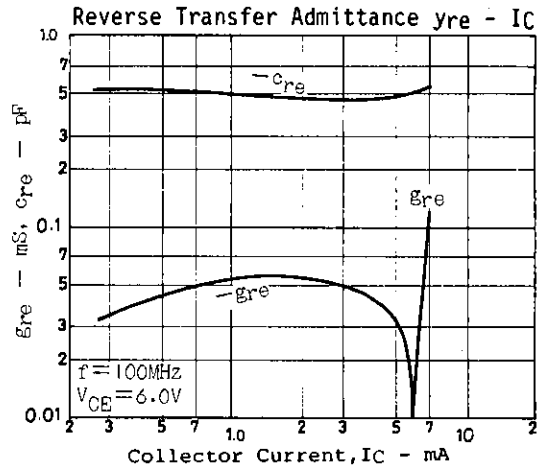
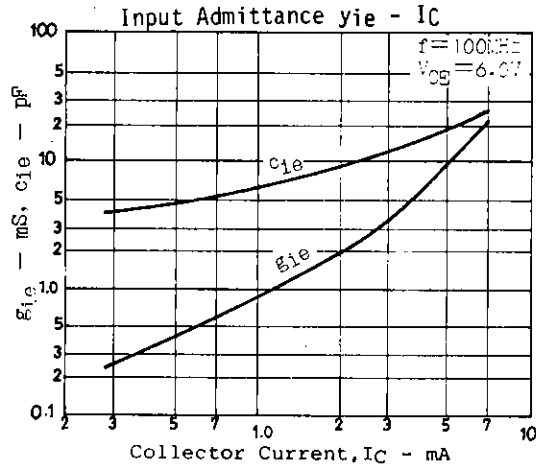
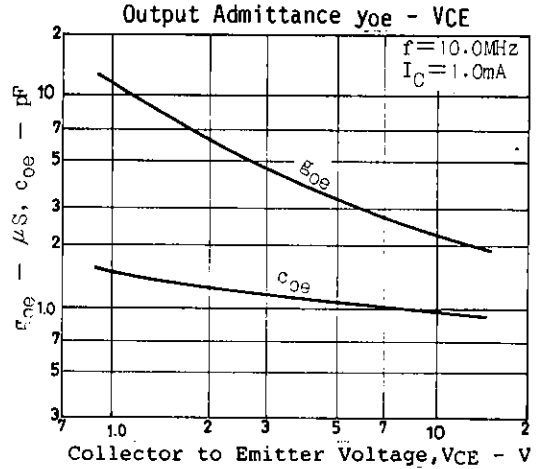
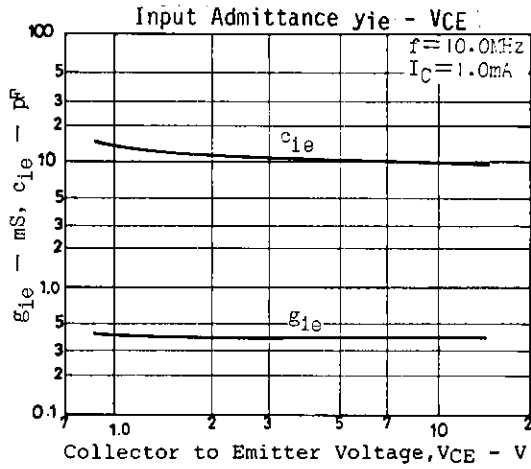

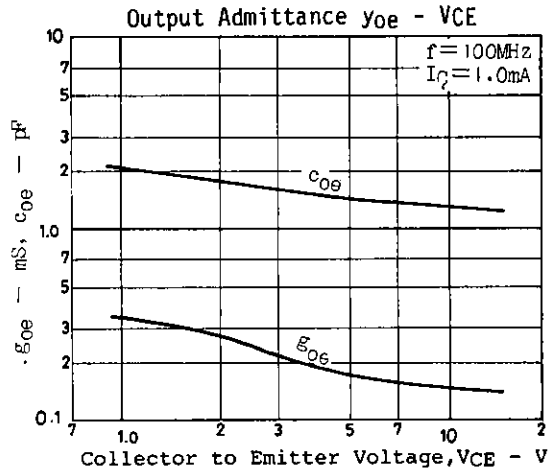
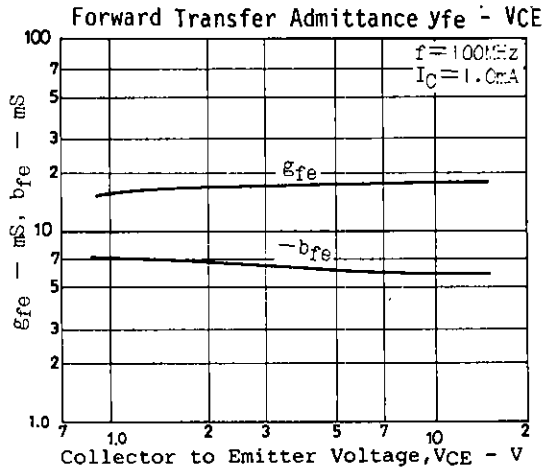

■ No products described or contained herein are intended for use in surgical implants, life-support systems, aerospace equipment, nuclear power control systems, vehicles, disaster/crime-prevention equipment and the like, the failure of which may directly or indirectly cause injury, death or property loss.

■ Anyone purchasing any products described or contained herein for an above-mentioned use shall:

- ① Accept full responsibility and indemnify and defend SANYO ELECTRIC CO., LTD., its affiliates, subsidiaries and distributors and all their officers and employees, jointly and severally, against any and all claims and litigation and all damages, cost and expenses associated with such use;
- ② Not impose any responsibility for any fault or negligence which may be cited in any such claim or litigation on SANYO ELECTRIC CO., LTD., its affiliates, subsidiaries and distributors or any of their officers and employees jointly or severally.

■ Information (including circuit diagrams and circuit parameters) herein is for example only; it is not guaranteed for volume production. SANYO believes information herein is accurate and reliable, but no guarantees are made or implied regarding its use or any infringements of intellectual property rights or other rights of third parties.