

4-CH OUTPUT STEREO AUDIO PROCESSOR WITH 4 STEREO INPUTS AND TONE/VOLUME CONTROL

DESCRIPTION

The SC7314 is a volume, tone (bass and treble), balance (left/ right) and fader (front/rear) processor for quality audio applications in car radio and Hi-Fi systems. Selectable input gain and external loudness function are provided. Control is accomplished by serial I²C bus microprocessor interface. The AC signal settings is obtained by resistor networks and switches combined with operational amplifiers. Due to the Used CMOS technology, low distortion, low noise and low DC stepping are obtained.

FEATURES

- * Input multiplexer:
 - 4 stereo inputs
 - Selectable input gain for optimal adaptation to different sources
- * Four speaker attenuators:
 - 4 independent speakers control in 1.25dB steps for balance and fader facilities
 - Independent mute function
- * All functions programmable via serial I²C Bus
- * Loudness function
- * Volume control in 1.25dB steps
- * Treble and bass control
- * Input and output for external equalizer or noise reduction system

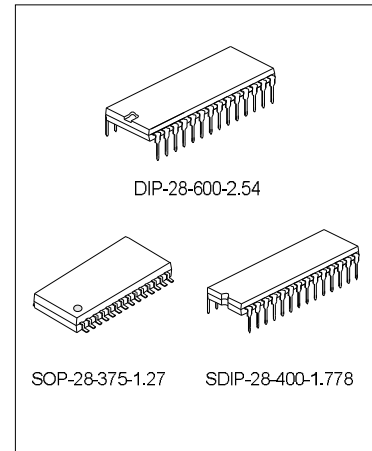

ORDERING INFORMATION

Device	Package
SC7314	DIP-28-600-2.54
SC7314S	SOP-28-375-1.27
SC7314D	SDIP-28-400-1.778

www.DataSheet4U.com

BLOCK DIAGRAM

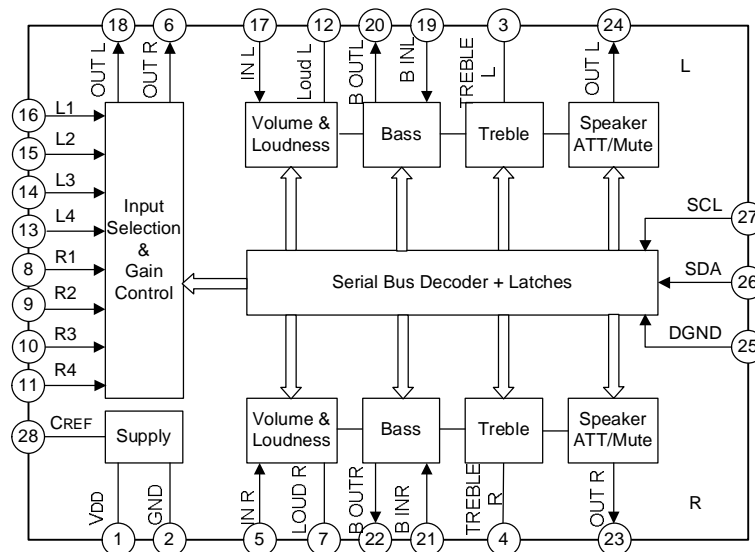

ABSOLUTE MAXIMUM RATINGS

Characteristics	Symbol	Ratings	Unit
Supply Voltage	V _S	10.5	V
Operating Temperature	T _{amb}	-20 ~ +75	°C
Storage Temperature	T _{stg}	-40 ~ +150	°C

QUICK REFERENCE DATA

Characteristics	Symbol	Min.	Typ.	Max.	Unit
Supply Voltage	V _s	6	9	10	V
Maximum Input Signal Handling	V _{CL}	2			V _{rms}
Total Harmonic Distortion ,V=1V _{rms} , f=1kHz	THD		0.01	0.1	%
Signal To Noise Ratio	S/N		106		dB
Channel Separation, f=1kHz	Sc		103		dB
Volume Control, 1.25dB Step		-78.75		0	dB
Bass And Treble Control, 2dB Step		-14		+14	dB
Fader And Balance Control, 1.25dB Step		-38.75		0	dB
Input Gain, 3.75dB Step		0		11.25	dB
Mute Attenuation			100		dB

ELECTRICAL CHARACTERISTICS (Refer to the test circuit)

(T_{amb}=25°C, V_S=9.0V, R_L=10kΩ, R_G=600Ω, all controls flat(G=0), f=1kHz, Unless otherwise specified)

Characteristics	Symbol	Test conditions	Min.	Typ.	Max.	Unit
SUPPLY VOLTAGE						
Operating Supply Voltage	V _S		6	9	10.0	V
Operating Supply Current	I _S			20.0	35.0	mA
Ripple Rejection Of Supply Voltage	SV _R		60	80		dB
INPUTS SELECTORS						
Input Resistance	R _{II}	Input 1, 2, 3, 4	35	50	70	kΩ
Clipping Level	V _{CL}		2	2.5		V _{rms}
Input Separation (note 2)	S _{IN}		80	100		dB
Output Load Resistance	R _L	Pin 6, 18	4			kΩ
Minimum Input Gain	G _{IN(MIN)}		-1	0	1	dB
Maximum Input Gain	G _{IN(MAX)}			11.25		dB
Step Resolution	G _{STEP}			3.75		dB
Input Noise	e _{IN}	G=11.25dB		2		μV
DC Steps	V _{DC}	Adjacent gain steps		4	20	mV
		G=18.75 to MUTE		4		mV

(To be continued)

(Continued)

Characteristics	Symbol	Test conditions	Min.	Typ.	Max.	Unit
VOLUME CONTROL						
Input Resistance	R _{IV}		20	33	50	k Ω
Control Range	C _{range}		70	75	80	dB
Minimum Attenuation	AV(min)		-1	0	1	dB
Maximum Attenuation	AV(max)		70	75	80	dB
Step Resolution	A _{STEP}		0.5	1.25	1.75	dB
Attenuation Set Error	EA	AV=0 to -20dB	-1.25	0	1.25	dB
		AV=-20 to -60dB	-3		2	
Tracking Error	ET				2	dB
DC Steps	V _{DC}	Adjacent attenuation steps		0	3	mV
		From 0dB to AV max		0.5	7.5	mV
SPEAKER ATTENUATORS						
Control Range	C _{range}		35	37.5	40	dB
Step Resolution	S _{STEP}		0.5	1.25	1.75	dB
Attenuation Set Error	EA				1.5	dB
Output Mute Attenuation	A _{MUTE}		80	100		dB
DC Steps	V _{DC}	Adjacent attenuation steps		0	3	mV
		From 0dB to MUTE		1	10	mV
BASS CONTROL (note 1)						
Control Range	GB	Maximum boost/cut	± 12	± 14	± 16	dB
Step Resolution	B _{STEP}		1	2	3	dB
Internal Feedback Resistance	RB		34	44	58	k Ω
TREBLE CONTROL (note 1)						
Control Range	G _t	Maximum boost/cut	± 13	± 14	± 15	dB
Step Resolution	T _{STEP}		1	2	3	dB
AUDIO OUTPUTS						
Clipping Level	V _{OCL}	THD=0.3%	2	2.5		V _{rms}
Output Load Resistance	R _L		4			k Ω
Output Load Capacitance	C _L				10	nF
Output Resistance	R _{OUT}		30	75	120	Ω
DC Voltage Level	V _{OUT}		4.2	4.5	4.8	V
GENERAL						
Output Noise	e _{NO}	BW=20 ~20kHz, flat output muted		2.5		μ V
		BW=20 ~20kHz, flat All gains=0dB		5	15	μ V
		A curve, all gains =0 dB		3		μ V
Signal To Noise Ratio	S/N	All gains=0dB; V _o =1V _{rms}		106		dB

(To be continued)

(Continued)

Characteristics	Symbol	Test conditions	Min.	Typ.	Max.	Unit
Distortion	d	$A_v=0, V_{IN}=10mV$		0.01	0.1	%
		$A_v=-20dB, V_{IN}=1V_{rms}$		0.09	0.3	%
		$A_v=-20dB, V_{IN}=0.3V_{rms}$		0.04		%
Channel Separation Left/Right	S_c		80	103		dB
Total Tracking Error		$A_v=0$ to -20 dB		0	1	dB
		$A_v=-20$ to -60 dB		0	2	dB
BUS INPUTS						
Input Low Voltage	V_{IL}				1	V
Input High Voltage	V_{IH}		3			V
Input Current	I_{IN}		-5		+5	μA
Output Voltage SDA Acknowledge	V_o	$I_o=1.6mA$			0.4	V

NOTES:

- (1) Bass and treble response see Figure 16. The center frequency and quality of the response behavior can be chosen by the external circuitry. A standard first order bass response can realized by a standard feedback network.
- (2) The selected input is grounded through the $2.2\mu F$ capacitor.

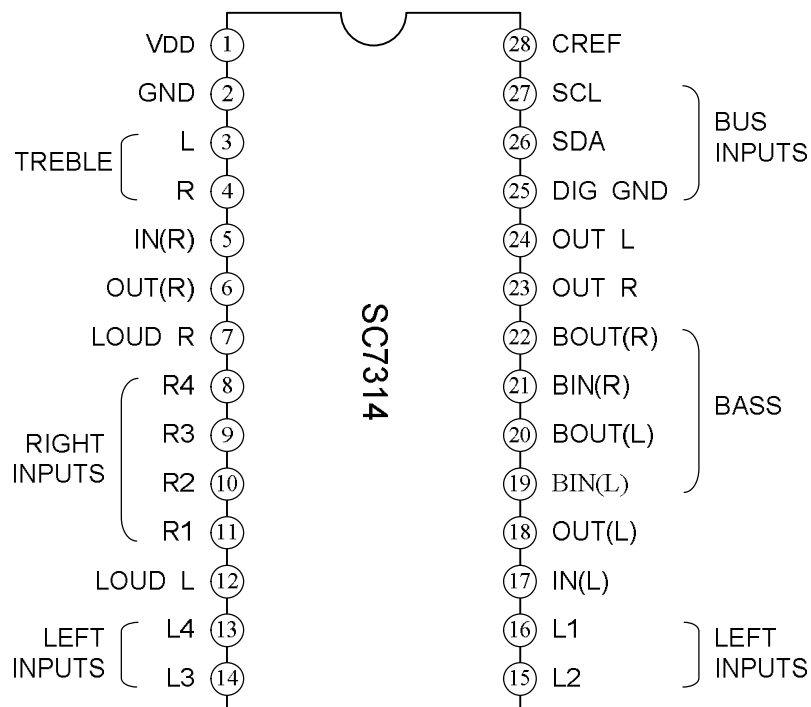
PIN CONFIGURATIONS

TYPICAL CHARACTERISTICS PERFORMANCE

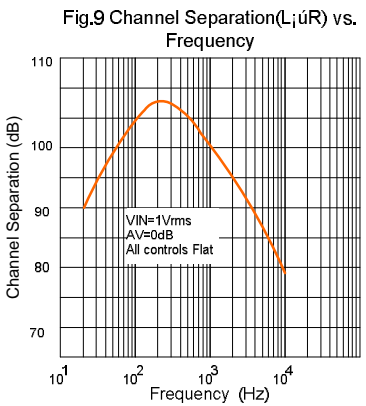
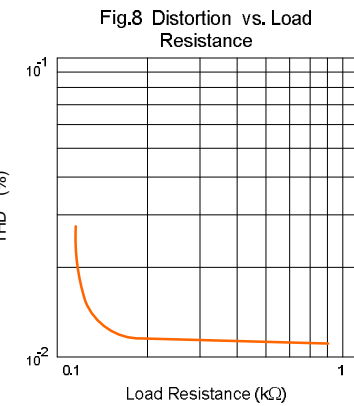
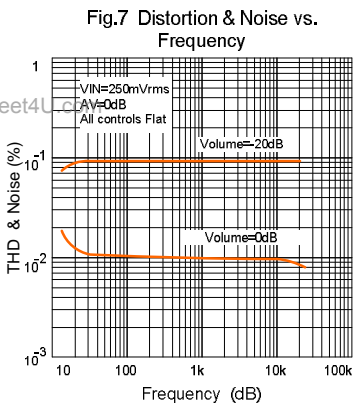
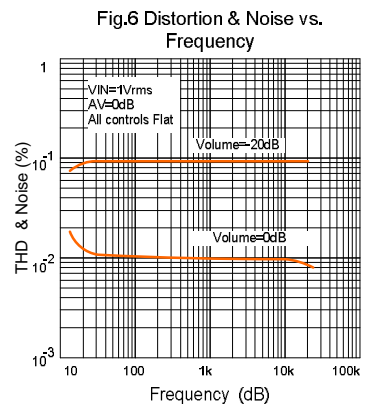
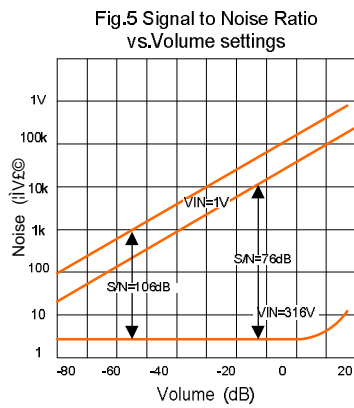
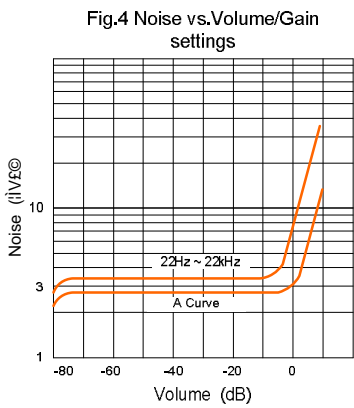
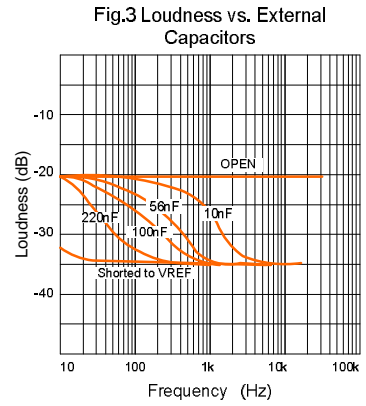
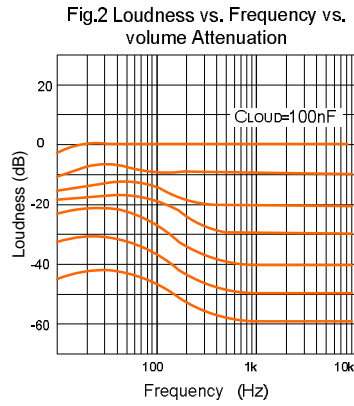
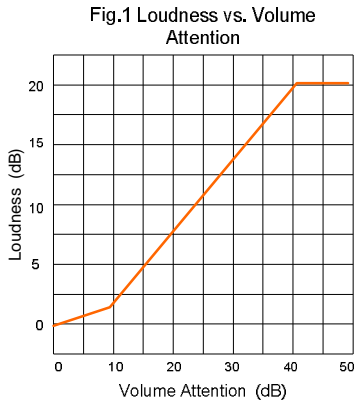

TYPICAL CHARACTERISTICS PERFORMANCE (continued)

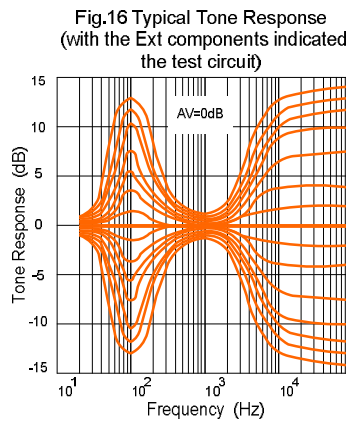
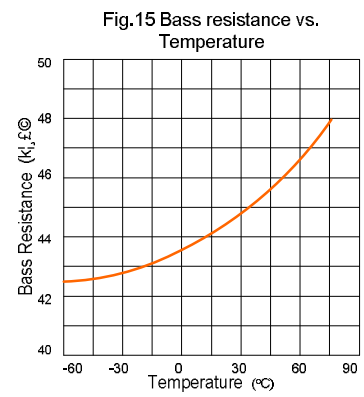
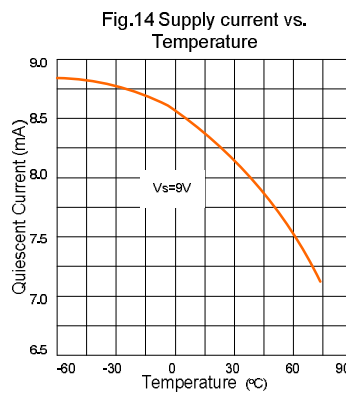
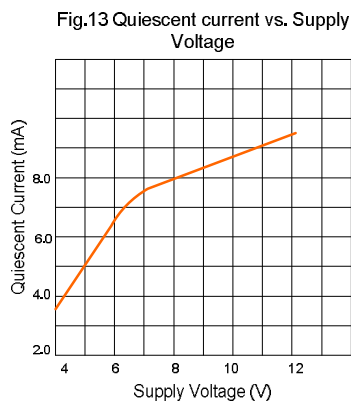
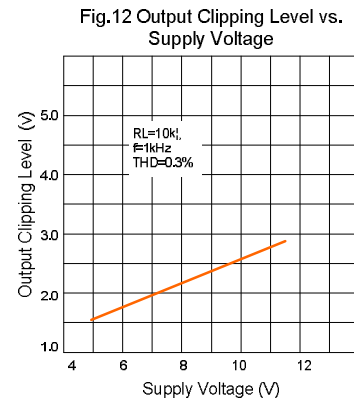
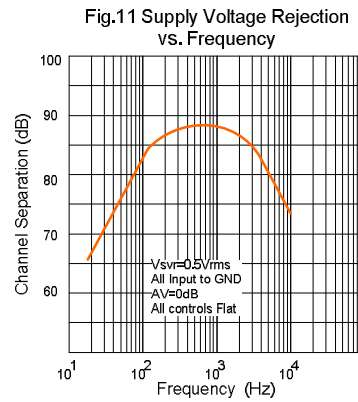
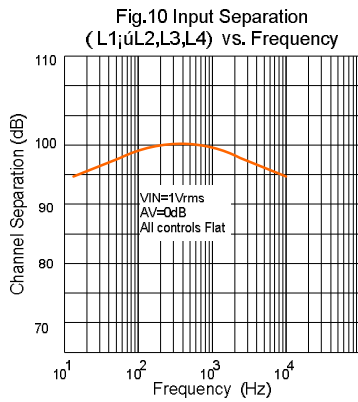

APPLICATION NOTES

1. I²c bus interface

Data transmission from microprocessor to the SC7314 and viceversa takes place through the 2 wires I²C BUS interface, consisting of the two lines SDA and SCL(pull-up resistors to positive supply voltage must be connected).

2.Data validity

As shown in Figure 17, the data of the SDA line must be stable during the high period of the clock. The HIGH and LOW state of the data line can only change when the clock signal on the SCL line is LOW.

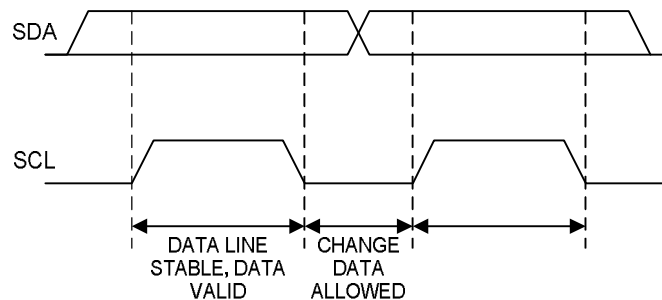

Fig. 17 Data Validity on the I²C BUS

3. Start and stop conditions

As shown in Figure 18, a start condition is a HIGH to LOW transition of the SDA line while SCL is HIGH. The stop condition is a LOW to HIGH transition of the SDA line while SCL is HIGH.

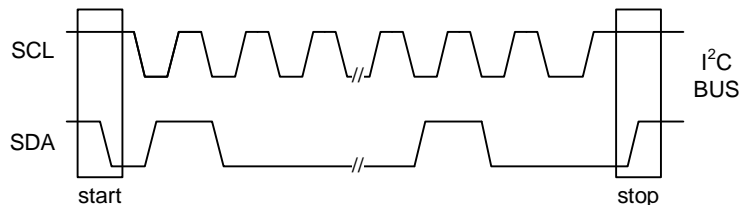

Fig. 18 Timing diagram of I²C BUS

4. Byte format

Every byte transferred on the SDA line must obtain 8 bits. Each byte must be followed by the an acknowledge bit. The MSB is transferred first.

5. Acknowledge

The master (microprocessor) puts a resistive HIGH level on the SDA line during the acknowledge clock pulse(see Figure 19). The peripheral (audioprocessor) that acknowledges has to pull-down (LOW) the SDA line during the acknowledge clock pulse, so that the SDA line is stable LOW during this clock pulse.

The audioprocessor which has been addressed has to generate an acknowledge after the reception of each byte, otherwise the SDA line remain at the HIGH level during the ninth clock pulse time. In this case the master transmitter can generate the STOP information in order to abort the transfer.

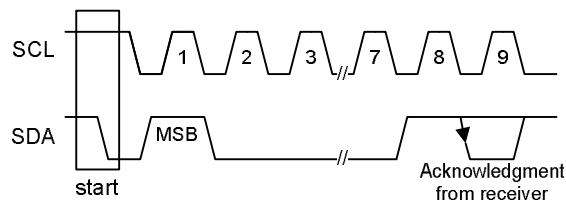

Fig. 19 Acknowledge on the I²C BUS

6. Transmission without acknowledge

Avoiding to detect the acknowledge of the audioprocessor, the microprocessor can use a simpler transmission: simply it waits one clock without checking the slave acknowledgedig, and sends the new data.

This approach of course is less protected from mis-working and decreases the noise immunity.

SOFTWARE SPECIFICATION

1. Interface protocol

The interface protocol comprises:

- A start conditions
- A chip address byte, containing the SC7314 address (the 8th bit of the bytes must be 0). The SC7314 must always acknowledge at the end of each transmitted byte.
- A sequence of data(N-bytes + acknowledge)
- A stop condition (P)

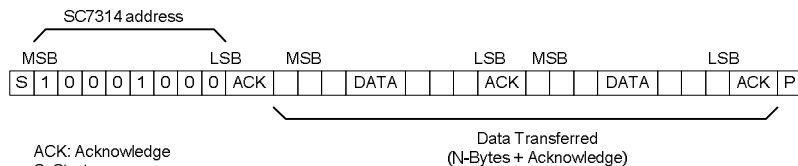

ACK: Acknowledge
S: Start
P: Stop
Max clock speed: 100kbts/sec

www.DataSheet4U.com

2. Chips address

1 (MSB)	0	0	0	1	0	0	0 (LSB)
---------	---	---	---	---	---	---	---------

3. Data bytes

MSB						LSB	Function	
0	0	B2	B1	B0	A2	A1	A0	Volume Control
1	1	0	B1	B0	A2	A1	A0	Speaker ATT L
1	1	1	B1	B0	A2	A1	A0	Speaker ATT R
0	1	0	G1	G0	S2	S1	S0	Audio switch
0	1	1	0	C3	C2	C1	C0	Bass control
0	1	1	1	C3	C2	C1	C0	Treble control

Note: Ax=1.25dB steps;Bx=10dB steps;Cx=2dB steps;Gx=3.75dB steps

SDETAILED DESCRIPTION OF DATA BYTES**1. Volume**

MSB							LSB	Function
0	0	B2	B1	B0	A2	A1	A0	Volume 1.25dB steps
					0	0	0	0
					0	0	1	-1.25
					0	1	0	-2.5
					0	1	1	-3.75
					1	0	0	-5
					1	0	1	-6.25
					1	1	0	-7.5
					1	1	1	-8.75
0	0	B2	B1	B0	A2	A1	A0	Volume 10dB steps
		0	0	0				0
		0	0	1				-10
		0	1	0				-20
		0	1	1				-30
		1	0	0				-40
		1	0	1				-50
		1	1	0				-60
		1	1	1				-70

For example, a volume of -45dB is given by: 00100100

2. Speaker attenuators

MSB							LSB	Function
1	1	0	B1	B0	A2	A1	A0	Speaker ATT L
1	1	1	B1	B0	A2	A1	A0	Speaker ATT R
					0	0	0	0
					0	0	1	-1.25
					0	1	0	-2.5
					0	1	1	-3.75
					1	0	0	-5
					1	0	1	-6.25
					1	1	0	-7.5
					1	1	1	-8.75
		0	0					0
		0	1					-10
		1	0					-20
		1	1					-30
		1	1	1	1	1	1	MUTE

For example, attenuation of 25dB on speaker R is given by: 11110100

3. Audio switch

MSB							LSB	Function
0	1	0	G1	G0	S2	S1	S0	Audio switch
						0	0	Stereo 1
						0	1	Stereo 2
						1	0	Stereo 3
						1	1	Stereo 4
					0			Loudness ON
					1			Loudness OFF
			0	0				+11.25dB
			0	1				+7.5dB
			1	0				+3.75dB
			1	1				0dB

For example, to select the stereo 2 input with a gain of +7.5dB Loudness ON the 8bit string is: 01001001

4. Bass and treble

MSB							LSB	Function
0	1	1	0	C3	C2	C1	C0	Bass
0	1	1	1	C3	C2	C1	C0	Treble
					0	0	0	-14
					0	0	1	-12
					0	0	1	-10
					0	0	1	-8
					0	1	0	-6
					0	1	0	-4
					0	1	1	-2
					0	1	1	0
					1	1	1	0
					1	1	1	0
					1	1	0	1
					1	1	0	0
					1	0	1	1
					1	0	1	0
					1	0	0	1
					1	0	0	0

C3=Sign

For Example, bass at -10dB is obtained by the following 8bit string is: 01100010.

TEST AND TYPICAL APPLICATION CIRCUIT

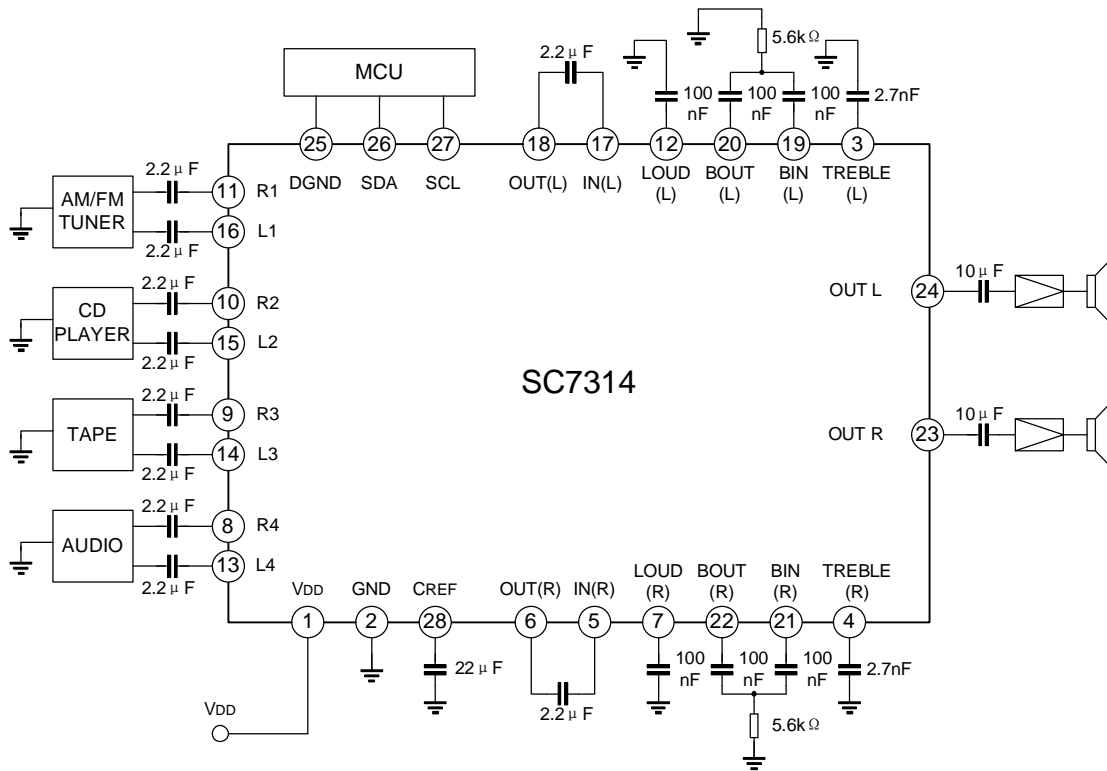

PACKAGE OUTLINE

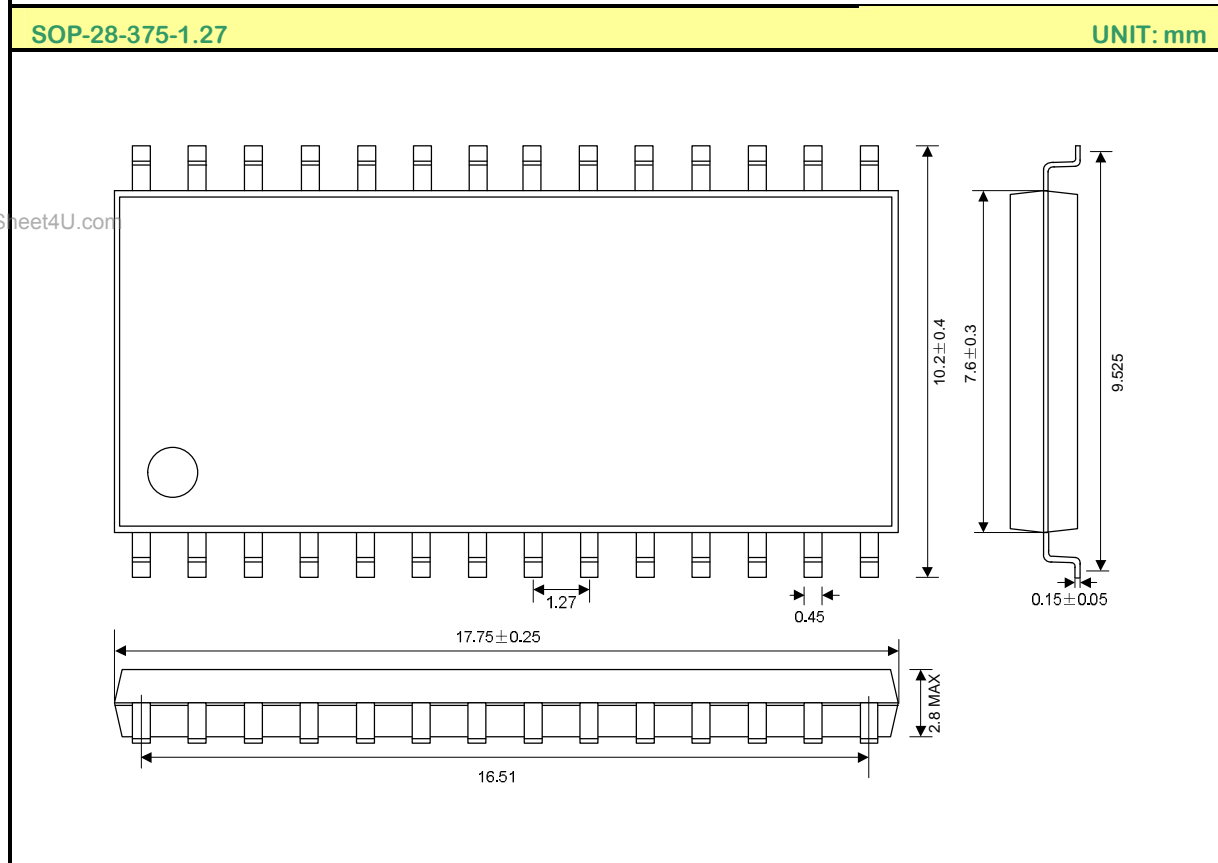
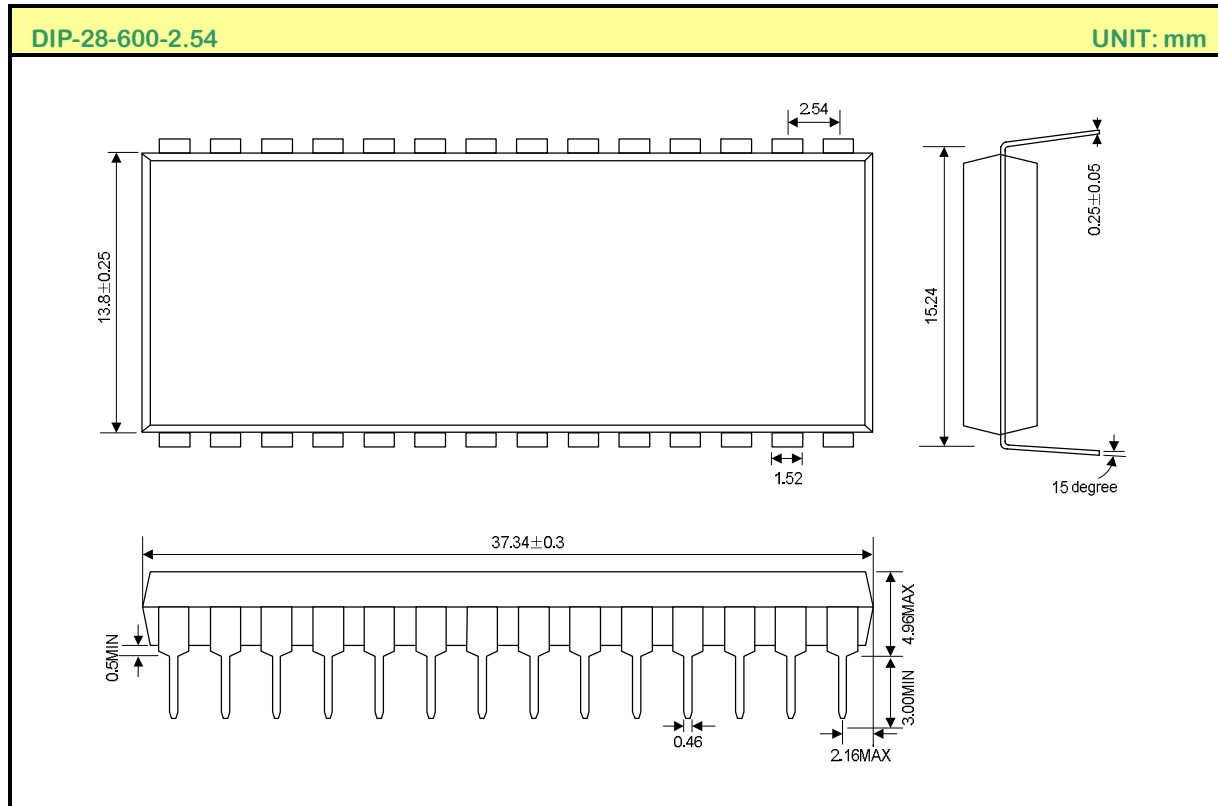

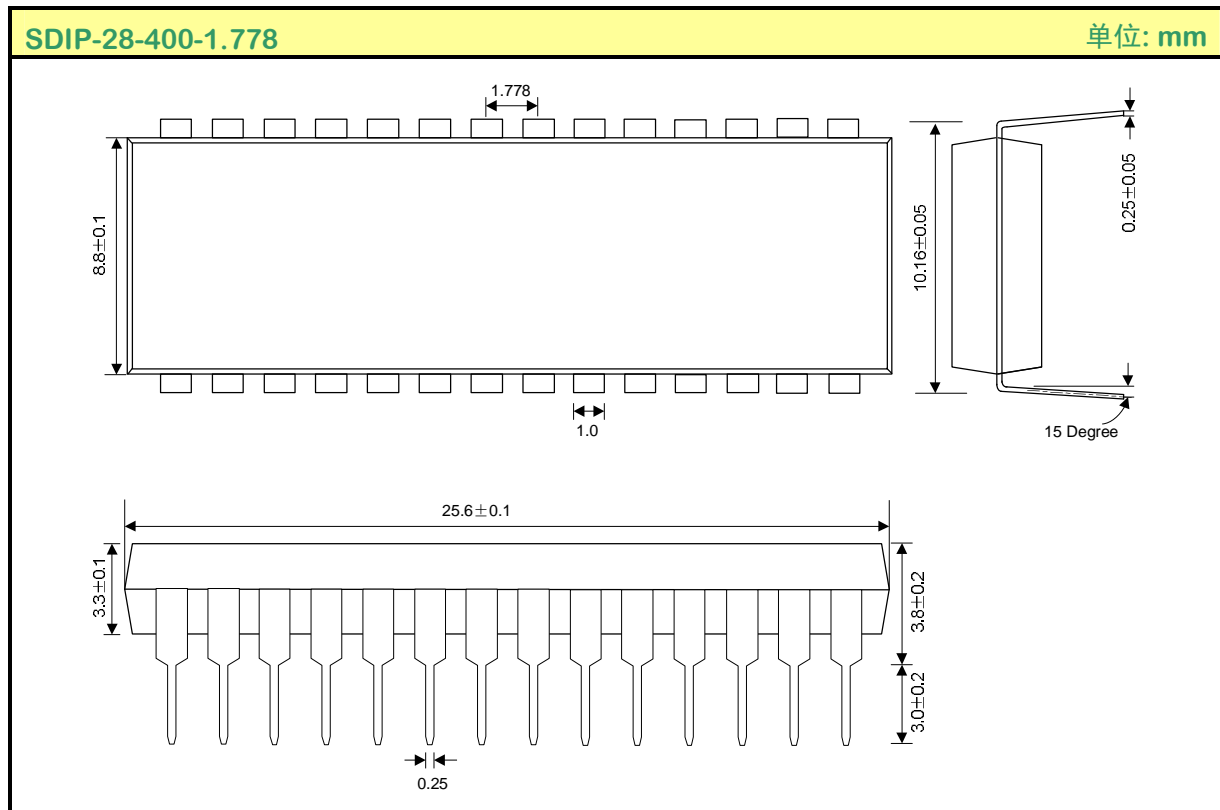
PACKAGE OUTLINE

www.DataSheet4U.com

HANDLING MOS DEVICES:

Electrostatic charges can exist in many things. All of our MOS devices are internally protected against electrostatic discharge but they can be damaged if the following precautions are not taken:

- Persons at a work bench should be earthed via a wrist strap.
- Equipment cases should be earthed.
- All tools used during assembly, including soldering tools and solder baths, must be earthed.
- MOS devices should be packed for dispatch in antistatic/conductive containers.