

## CD SERVO CONTROLLER WITH MCU

### DESCRIPTIONS

SC9696P is a CD play controller with CD player, remote control decoding, clock display mature function , which includes CD digital servo controller, CD signal processor, digital audio DAC output, with interface supporting wma/mp3 encoding/decoding circuit, TunePLL circuit SC9257, electronic volume control circuit, LCD drive circuit SC2124 and compatible with TAPE and AUX IN.

### FEATURES

- \* CD play
  - Compatible with CD/CD-R/CD-RW
  - Support CD play/pulse
  - Support CD Pre/Next
  - Support CD FF/FB
  - Support single music playback/catalog circle play & display
  - Support CD random access & display
  - Support browse play
  - Support CD sync tape recording
- \* Receiving
  - Support bands select in four areas (USA, GEN 1/2, JAPAN)
  - Support manually channel tuning forward/backward
  - Support automatically channel tuning forward/backward
  - Support channel preset (FM: 20, AM/MW:10)
- \* Taping
  - Support TAPE display
- \* AUX
  - Support AUX input
- \* Electronic volume control
  - Support CD/receiving/tape/AUX voice channel electronic switching
  - Support volume adjust & display
  - Support voice mode FLAT, POP, CLASS, ROCK, JAZZ5 preset
  - Support mute switch control & display
  - Support X-BASS switch control & fdisplay
  - Support ENCODER-VOLUME control
- \* Clock
  - Support Clock display & adjust
  - Support alarm, alarm turn on/off
  - Support sleep mode

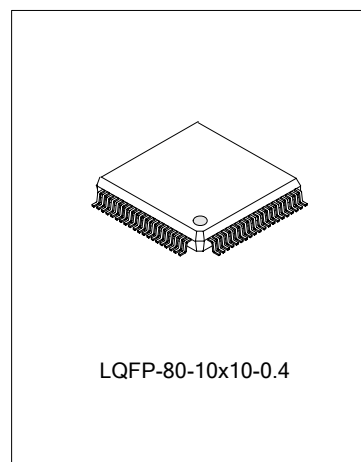

### ORDERING INFORMATION

Device	Package	Seal
SC9696P	LQFP-80-10x10-0.4	SC9696P

### APPLICATIONS

- \* Desktop audio system

**BLOCK DIAGRAM**

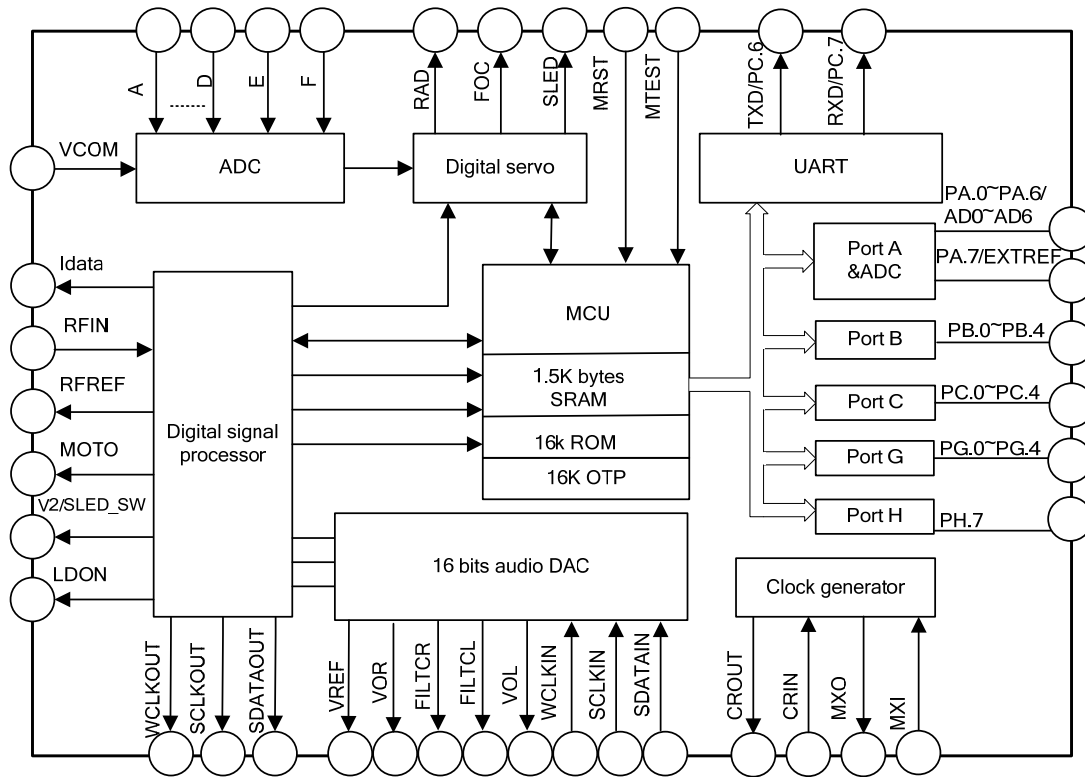

**ABSOLUTE MAXIMUM RATING (Tamb=25°C)**

Characteristics	Symbol	Rating	Unit
Supply Voltage	VDD	-0.5 ~ +5.5	V
Input Voltage on Pins	VIN	-0.5 ~VDD + 0.5	V
Operating Temperature	Topr	-20 ~ +75	°C

**ELECTRICAL CHARACTERISTICS (VDD=4.5~5.5V; VSS=0V; Tamb=-10~+50°C)**

Characteristics	Symbol	Test condition	Min.	Typ.	Max.	Unit
MCU Operating Voltage	MVDD	—	4.0	5.0	5.5	V
Operating Voltage	VDD	Exception MCU	4.5	5.0	5.5	V
Operating Current	IDD	5V(CD operating)	—	50	—	mA
RFIN Input Signal	VRFIN	—	—	1	—	V
Reference Voltage	Vlr	—	—	0.5VDD	—	
Photoelectricity Signal Bias Input	Vcom	—	—	2.5	—	V
Input Current Of Central Diode B	IDB	—	0	—	9	μA
Input Current Of Central Diode A	IDA	—	0	—	9	μA

Characteristics	Symbol	Test condition	Min.	Typ.	Max.	Unit
Input Current Of Central Diode C	IDC	—	0	—	9	μA
Input Current Of Central Diode D	IDD	—	0	—	9	μA
Input Current Of Satellite Diode F	IRF	—	0	—	4.5	uA
Input Current Of Satellite Diode E	IRE	—	0	—	4.5	μA
Low-level Output Current at PA Port.	IOL(A)	—	—	10	—	mA
High-level Output Current at PA Port.	IOH(A)	—	—	5	—	mA
Low-level Output Current at PB Port.	IOL(B)	—	—	10	—	mA
High-level Output Current at PB Port.	IOH(B)	—	—	5	—	mA
Low-level Output Current at PC Port.	IOL(C)	—	—	10	—	mA
High-level Output Current at PC Port.	IOH(C)	—	—	5	—	mA
Low-level Output Current at PG Port.	IOL(G)	—	—	10	—	mA
High-level Output Current at PG Port.	IOH(G)	—	—	5	—	mA
Low-level Output Current at PH Port.	IOL(H)	—	—	10	—	mA
High-level Output Current at PH Port.	IOH(H)	—	—	5	—	mA
LDON Low-level Output Current	ILDON	—	0	—	2	mA
Load Resistance DAC	RL	Left channel is the same as the right.	5	—	—	KΩ
Full-Scale DAC Output Voltage	VFS	Left channel is the same as the right.	0.9	1.1	1.2	V
RAD Output Current	IRAD	High level is the same as the low level.	0	1	—	mA
FOC Output Current	IFOC	High level is the same as the low level.	0	1	—	mA
SLED Current	ISLED	High level is the same as the low level.	0	1	—	mA
MOTO Output Current	IMOTO	High level is the same as the low level.	0	5	10	mA

Characteristics	Symbol	Test condition	Min.	Typ.	Max.	Unit
Low Level Output Driving Voltage	VOLDRIVE1	RAD, FOC, SELD	0	—	0.4	V
High Level Output Driving Voltage	VOHDRIVE1	RAD, FOC, SELD	VDD-0.4	—	VDD	V
Moto Low Level Output Voltage	VOLmoto	—	0	—	1.0	V
Moto High Level Output Voltage	VOHmoto		VDD-1	-	VDD	V
Driving Current of high impedance	IZODRIVE	RAD, FOC, SELD, MOTO	-10	0	+10	μA
DAC Total Harmonic Distortion	THD	0dB 1KHz Signal Input	-	-65	-	dB
DAC output Signal to Noise	S/N	No signal input	-	90	100	dB
DA Filter Attenuation	Filter_DA	0 to 19 KHz	-	-	0.001	dB
		19 to 20 KHz	1	-	2	dB
		24KHz	25	-	-	dB
		25 to 35 KHz	40	-	-	dB
		35 to 64 KHz	50	-	-	dB
		64 to 68 KHz	31	-	-	dB
		68KHz	35	-	-	dB
69 to 88KHz	40	-	-	dB		
OSC Frequency	Fsystem		—	16.9344	—	MHz

PIN CONFIGURATIONS

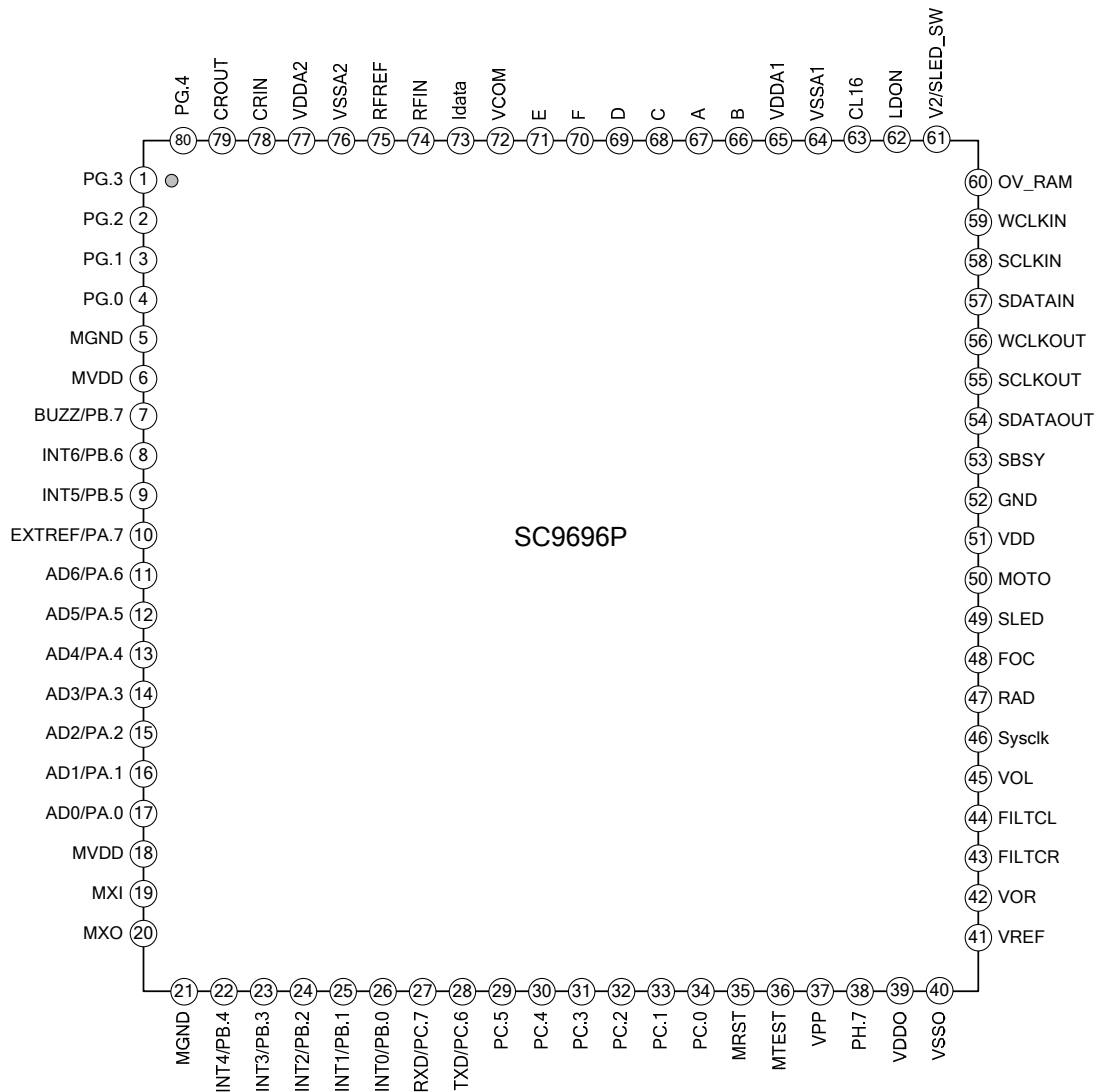

**PIN DESCRIPTIONS**

Pin no.	Pin name	I/O	Descriptions
1	PG.3	I/O	General purpose IO port, input bit by bit control with pull-up, output pull-up close
2	PG.2	I/O	General purpose IO port, input bit by bit control with pull-up, output pull-up close
3	PG.1	I/O	General purpose IO port, input bit by bit control with pull-up, output pull-up close
4	PG.0	I/O	General purpose IO port, open-drain input bit by bit control with pull-up, output forced to pull-up
5	MGND	I	MCU and periphery ground
6	MVDD	I	MCU and periphery power supply
7	BUZZ/PB.7	I/O	General purpose IO port, input bit by bit control with pull-up, output pull-up close, Schmitt input
8	INT6/PB.6	I/O	General purpose IO port, input bit by bit control with pull-up, output pull-up close, Schmitt input
9	INT5/PB.5	I/O	General purpose IO port, input bit by bit control with pull-up, output pull-up close, Schmitt input
10	EXTREF/PA.7	I/O	General purpose IO port Also used as AD reference voltage input
11	AD6/PA.6	I/O	General purpose IO port Also used as AD switch channel 6
12	AD5/PA.5	I/O	General purpose IO port Also used as AD switch channel 5
13	AD4/PA.4	I/O	General purpose IO port Also used as AD switch channel 4
14	AD3/PA.3	I/O	General purpose IO port Also used as AD switch channel 3
15	AD2/PA.2	I/O	General purpose IO port Also used as AD switch channel 2
16	AD1/PA.1	I/O	General purpose IO port Also used as AD switch channel 1
17	AD0/PA.0	I/O	General purpose IO port Also used as AD switch channel 0
18	MVDD	I	MCU and periphery power supply
19	MXI	I	75K oscillator input port
20	MXO	O	75K oscillator output port
21	MGND	I	MCU and periphery ground
22	INT4/PB.4	I/O	General purpose IO port, input bit by bit control with pull-up, output pull-up close, Schmitt input
23	INT3/PB.3	I/O	General purpose IO port, input bit by bit control with pull-up, output pull-up close, Schmitt input

Pin no.	Pin name	I/O	Descriptions
24	INT2/PB.2	I/O	General purpose IO port, input bit by bit control with pull-up, output pull-up close, Schmitt input
25	INT1/PB.1	I/O	General purpose IO port, input bit by bit control with pull-up, output pull-up close, Schmitt input
26	INT0/PB.0	I/O	General purpose IO port, input bit by bit control with pull-up, output pull-up close, Schmitt input
27	RXD/PC.7	I/O	General purpose IO port, input bit by bit control with pull-up, output pull-up close and also used as serial data receiving.
28	TXD/PC.6	I/O	General purpose IO port, input bit by bit control with pull-up, output pull-up close and also used as serial data transmitting.
29	PC.5	I/O	General purpose IO port, input bit by bit control with pull-up, output pull-up close
30	PC.4	I/O	General purpose IO port, input bit by bit control with pull-up, output pull-up close
31	PC.3	I/O	General purpose IO port, open-drain, input bit by bit control with pull-up, output forced to pull-up
32	PC.2	I/O	General purpose IO port, open-drain, input bit by bit control with pull-up, output forced to pull-up
33	PC.1	I/O	General purpose IO port, open-drain, input bit by bit control with pull-up, output forced to pull-up
34	PC.0	I/O	General purpose IO port, open-drain, input bit by bit control with pull-up, output forced to pull-up
35	MRST	I	MCU reset
36	MTEST	I	MCU test port, connected to ground when normal working
37	VPP	I	OTP high voltage download
38	PH.7	I/O	Common IO port without pull-up or pull-down resistor
39	VDDO	I	DAC analog power supply
40	VSSO	I	DAC analog ground
41	VREF	O	DAC reference voltage output
42	VOR	O	DAC right channel output
43	FILTCR	O	DAC right channel filter capacitor.
44	FILTCL	O	DAC left channel filter capacitor.
45	VOL	O	DAC left channel output
46	Sysclk	I	DAC system clock input
47	RAD	O	Tracking drive output
48	FOC	O	Focus drive output
49	SLED	O	Sled drive output
50	MOTO	O	Spindle drive output
51	VDD	I	Core digital voltage
52	GND	I	Core digital ground
53	SBSY	O	Sub code sync output signal
54	SDATAOUT	O	Audio data output

Pin no.	Pin name	I/O	Descriptions
55	SCLKOUT	O	Data bit clock output
56	WCLKOUT	O	Data word clock output
57	SDATAIN	I	Audio data input
58	SCLKIN	I	Data bit clock input
59	WCLKIN	I	Data word clock input
60	OV_RAM	O	Internal SRAM overflow signal
61	V2/SLED_SW	I	Sledge motor position monitor signal input
62	LDON	O	Laser control signal output
63	CL16	O	16M clock output
64	VSSA1	I	Ground
65	VDDA1	I	Power supply
66	B	I	Central diode current signal input 1
67	A	I	Central diode current signal input 2
68	C	I	Central diode current signal input 3
69	D	I	Central diode current signal input 4
70	F	I	Satellite diode current signal input 1
71	E	I	Satellite diode current signal input 2
72	VCOM	I	Photoelectricity Signal Bias Input
73	Idata	O	Data Slice feed-back current output
74	RFIN	I	Reference Signal.
75	RFREF	O	Reference Signal reference voltage/level adjustment reference current output
76	VSSA2	I	Ground
77	VDDA2	I	Power supply
78	CRIN	I	8M oscillator input
79	CROUT	O	8M oscillator output
80	PG.4	I/O	General purpose IO port, input bit by bit control with pull-up, output pull-up close





## FUNCTION DESCRIPTIONS

### 1. LCD

SC2124 is adopted for LCD drive circuit.

LCD with 4COM×32SEG, 3V, 1/4duty and 1/3 bias is adopted, as shown below:

Truth table:

	COM0	COM1	COM2	COM3
SEG0	1F	1H	1G	1E
SEG1	1A	1J	1P	
SEG2	1K	1M	1N	1D
SEG3	CD	1B	1C	\
SEG4	2F	2H	2G	2E
SEG5	2A	2J	2P	USB
SEG6	2K	2M	2N	2D
SEG7	MP3	2B	2C	WMA
SEG8	3F	3H	3G	3E
SEG9	3A	3J	3P	ID3
SEG10	3K	3M	3N	3D
SEG11		3B	3C	
SEG12	4F	4H	4G	4E
SEG13	4A	4J	4P	FOLDER
SEG14	4K	4M	4N	4D
SEG15	REPEAT	4B	4C	ALL
SEG16	5F	5H	5G	5E
SEG17	5A	5J	5P	MEMORY
SEG18	5K	5M	5N	5D
SEG19	STEREO	5B	5C	RANDOM
SEG20	6F	6H	6G	6E
SEG21	6A	6J	6P	SLEEP
SEG22	6K	6M	6N	6D
SEG23	TIMER	6B	6C	TAPE
SEG24	7F	7H	7G	7E
SEG25	7A	7J	7P	AUX
SEG26	7K	7M	7N	7D
SEG27	:	7B	7C	INTRO
SEG28	8F	8H	8G	8E
SEG29	8A	8J	8P	.MHZ
SEG30	8K	8M	8N	8D
SEG31	MUTE	8B	8C	KHZ

## 2. Jumper

A/D Value	Pickup Mechanism		Clock & Timer
0.00~0.63V	SONY	KSS-213C	Enable
0.63~1.25V	SONY	KSS-213C	Disable
1.25~1.88V	THOMSON	TCP-11TK	Enable
1.88~2.50V	THOMSON	TCP-11TK	Disable
2.50~3.12V	SANYO	DA11	Enable
3.12~3.75V	SANYO	DA11	Disable
3.75~4.38V	SAMSUNG	V75	Disable
4.38~5.00V	SAMSUNG	V75	Enable

## 3. Keyboard

### 3.1 Panel keyboard arrangement

KEY0	KEY1	KEY2	KEY3
POWER	STOP/BAND	FUN_CDUSBSD	SLEEP
OPCL	PLAY	FUN_MODE	ID3
VOL UP	NEXT_FF		
VOL DN	PREV_FW	MEMORY	MUTE
FOLDER_UP(PRESET_UP)	REC/COPY	INTRO	EQ/ X-BASS
FOLDER_DN(PRESET_DN)	RPT	RANDOM	TIMER

### 3.2 Remote keyboard arrangement

	T0	T1	T2	T3
K0	POWER	MUTE	OPCL	
K1	FUN_MODE	STOP/BAND	FUN_CDUSBSD	EQ/ X-BASS
K2		NEXT_FF		
K3	VOL UP	PLAY	FOLDER_UP(PRESET_UP)	REC/COPY
K4	VOL DN	PREV_FW	FOLDER_DN(PRESET_DN)	
K5		MEMORY		
K6	INTRO	RANDOM	RPT	ID3
K7	TIMER			SLEEP

#### 4. Receiving interface mode

##### 4.1 Receiving band & area

Interface for connecting SC9257 (SC72131) 9257\_PERIOD/9257\_CLOCK/9257\_DATA

AREA	CODE	BAND	FREQUENCY RANGE[Hz]	STEP[Hz]	FREQ REF[Hz]	IF
USA	00	FM	87.50- 108.00M	50K	50K/3.125K	+10.7M/1.3375M
		MW	522-1620K	9K	9K	+450K
GEN1	01	FM	76.0-90.0M,TV1-3	100K,1CH	25K	-10.7M
		AM	522-1629K	9K	9K	+450K
GEN2	10	FM	87.50-108.00M	50K	50K/3.15K	+10.7M/1.3375M
		MW	522-1620K	9K	9K	+450K
		LW	144-281K	1K	1K	
JAPAN	11	FM	87.5-108.0M	100K	50K/3.125K	+10.7M/1.3375M
		AM	520-1710K	10K	10K	+450K

##### 4.2 Keys description

###### 1) Enter TUNER mode

Press POWER to turn on and press FUN\_MODE to enter TUNER mode

###### 2) STOP/BAND

Switch band: FM AM FM

###### 3) PREV\_REW

Press for a short time for manually channel tuning backward

Press for longer time for automatically channel tuning backward and stop after tuning.

###### 4) NEXT\_FF

Press for a short time for manually channel tuning forward

Press for longer time for automatically channel tuning forward and stop after tuning.

###### 5) PRESET\_UP/PRESET\_DN

Select preset channel or channel number (cyclic up/down)

###### 6) MEMORY

Press MEMORY for a long time to enter channel setting mode for preset channels

5. Receiving display

1) FM BAND

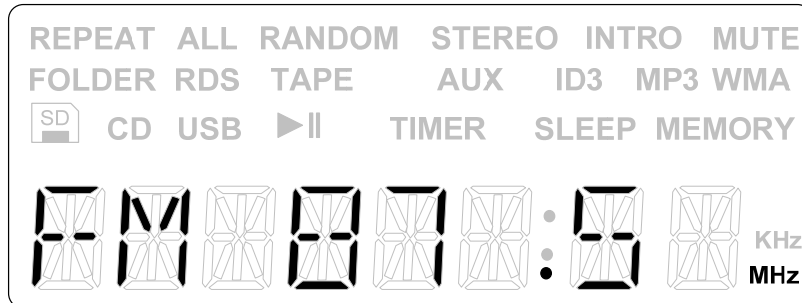

2) AM BAND

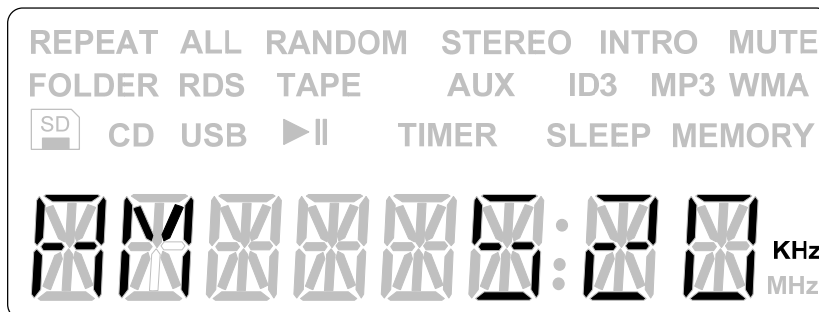

3) Display of select preset channel



4) Display after 0.5s



## 5) Display of channel memory

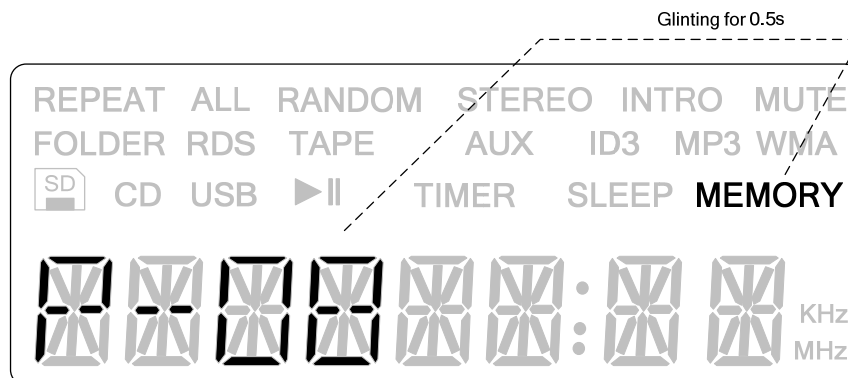

## 6. Tape mode

### 6.1 Key description

#### 1) Enter TAPE mode

Press POWER to turn on and press FUN\_MODE to enter TUNER mode.

#### 2) Display

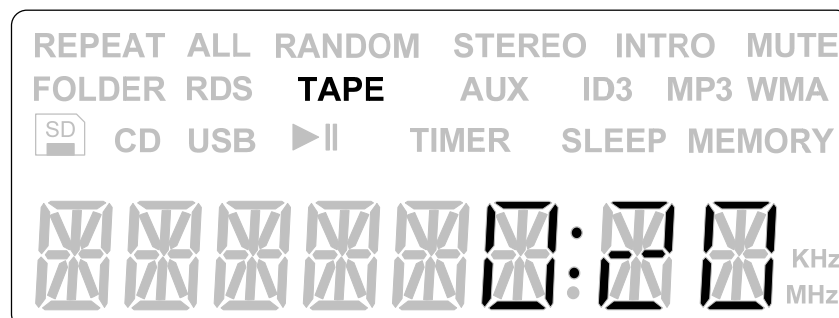

## 7. CD mode

### 7.1 Key description

#### 1) Enter CD PLAYER mode

Press POWER to turn on and press FUN\_MODE to enter CD/USB/SD mode, then press FUN\_CDUSBSD to enter CD PLAYER mode.

#### 2) PLAY/PAUSE

Play/pause key

#### 3) STOP

Stop key

**4) RANDOM**

Random access (PREV\_REW is invalid in this mode)

**5) PREV\_REW**

Press for a short time for previous music and for the last music if the current music is the first one.

Press for a long time for fast backward and release for stop, and for normal play if it comes to the beginning.

**6) NEXT\_FF**

Press for a short time for next music and for the first music if the current music is the last one.

Press for a long time for fast forward and release for stop, and for normal play if it comes to the last.

**7) REPEAT**

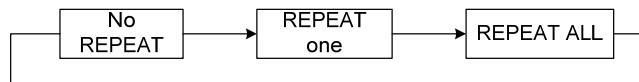

**8) MEMORY**

Enter edit mode (valid in STOP mode)

Press REW/FF to select music and press MEMORY to save and up to 20 music can be stored. Then press PLAY to play and it will exit this mode if there is no operation in 10s, with music reversed.

Press STOP to clear music and exit this mode.

**9) INTRO**

Browse play switch (10s before play)

**7.2 CD display**

**1) Display number of music and total time in STOP mode**



**2) Display in PLAY mode**



3) Display in PAUSE mode

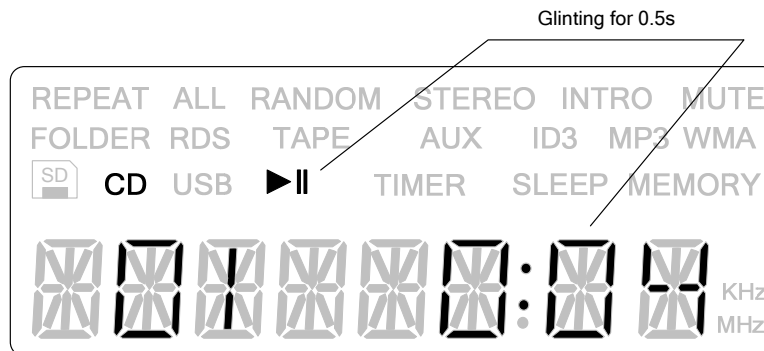

4) Display in REW/FF mode



5) Display in RANDOM mode



6) Display in REPEAT ONE



7) Display in REPEAT ALL



8) Display in PROGRAMMING DISPLAY mode



9) Display in PROGRAMMING mode

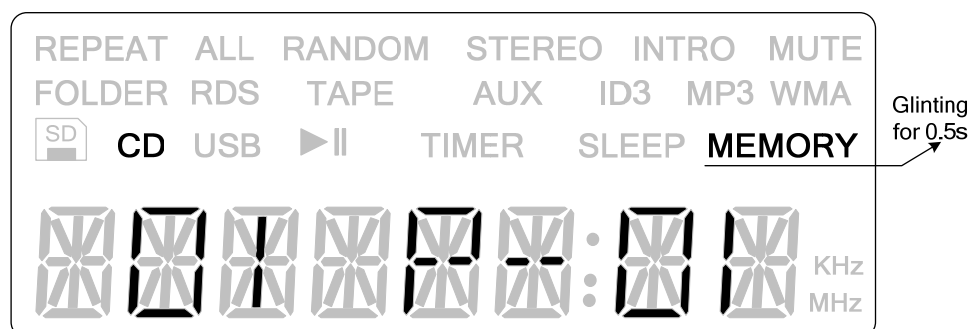

8. Volume mode

8.1 Key description

1) VOLUME+/-

Increase/decrease volume

2) MUTE

Mute on/off



### 3) EQ

Preset voice mode switch

FLAT JAZZ CLASSIC POP ROCK FLAT

### 8.2 Volume and sound effect display



### 8.3 JAZZ sound effect selected by EQ



## 9. Others

### 9.1 Key description

#### 1) CLOCK

Press MEMORY (CLOCK ADJ) for a long time in standby mode to enter time setting mode and press UP/DOWN to adjust.

#### 2) SLEEP

Press SLEEP to enter the mode and SLEEP glints, press it again for time setting (10~90 min) and SLEEP normally displays. Press it third time to cancel.

#### 3) TIMER

Timing turn on (alarm)

Press TIMER to enter timing mode and press MEMORY for a long time for time setting and adjust time through NEXT\_FF/PREC\_REW

#### 4) POWER

Standby and turn on.

## 9.2 Display

### 1) Standby



### 2) SLEEP



### 3) TIMER

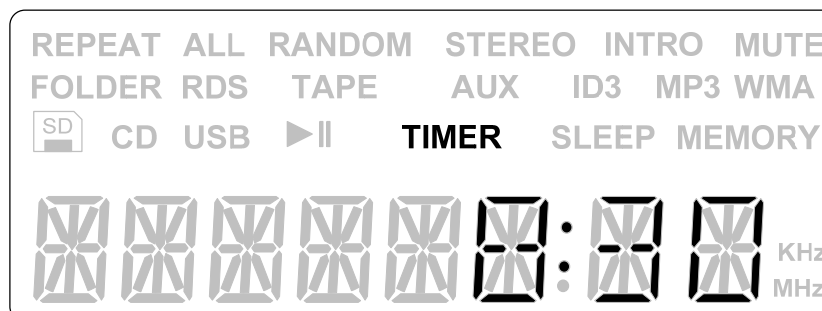

TYPICAL APPLICATION DIAGRAM

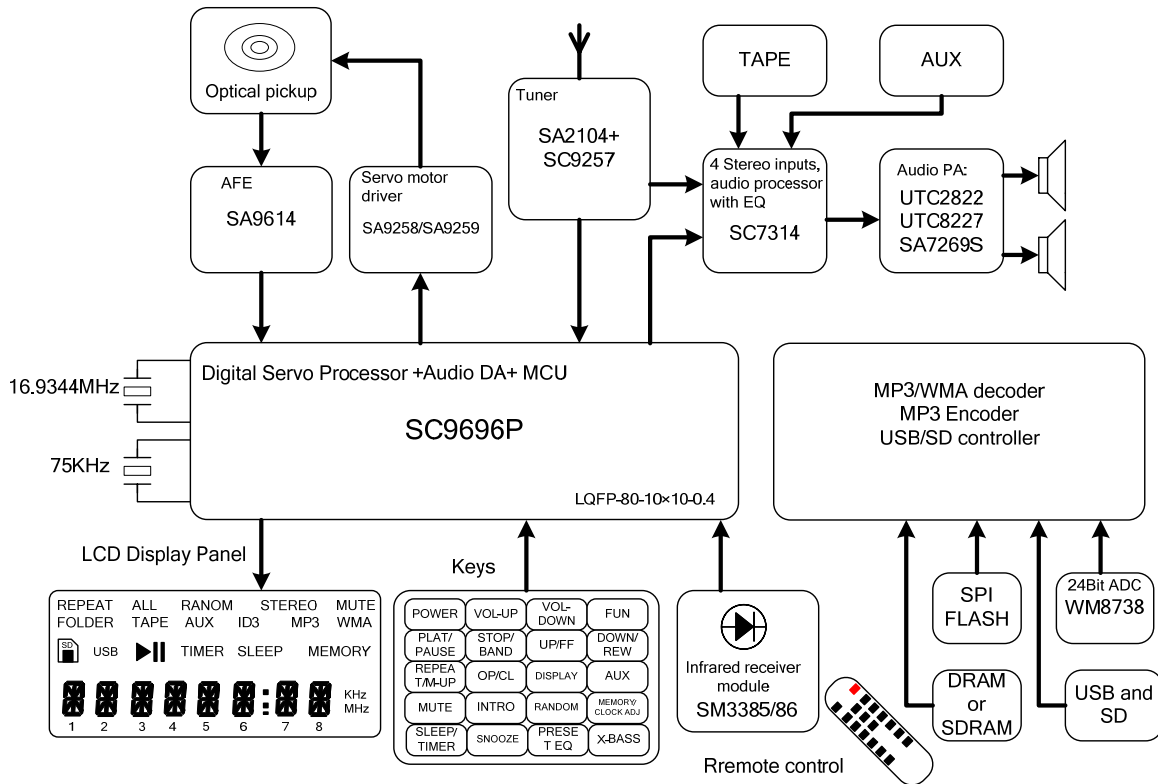

PACKAGE OUTLINE

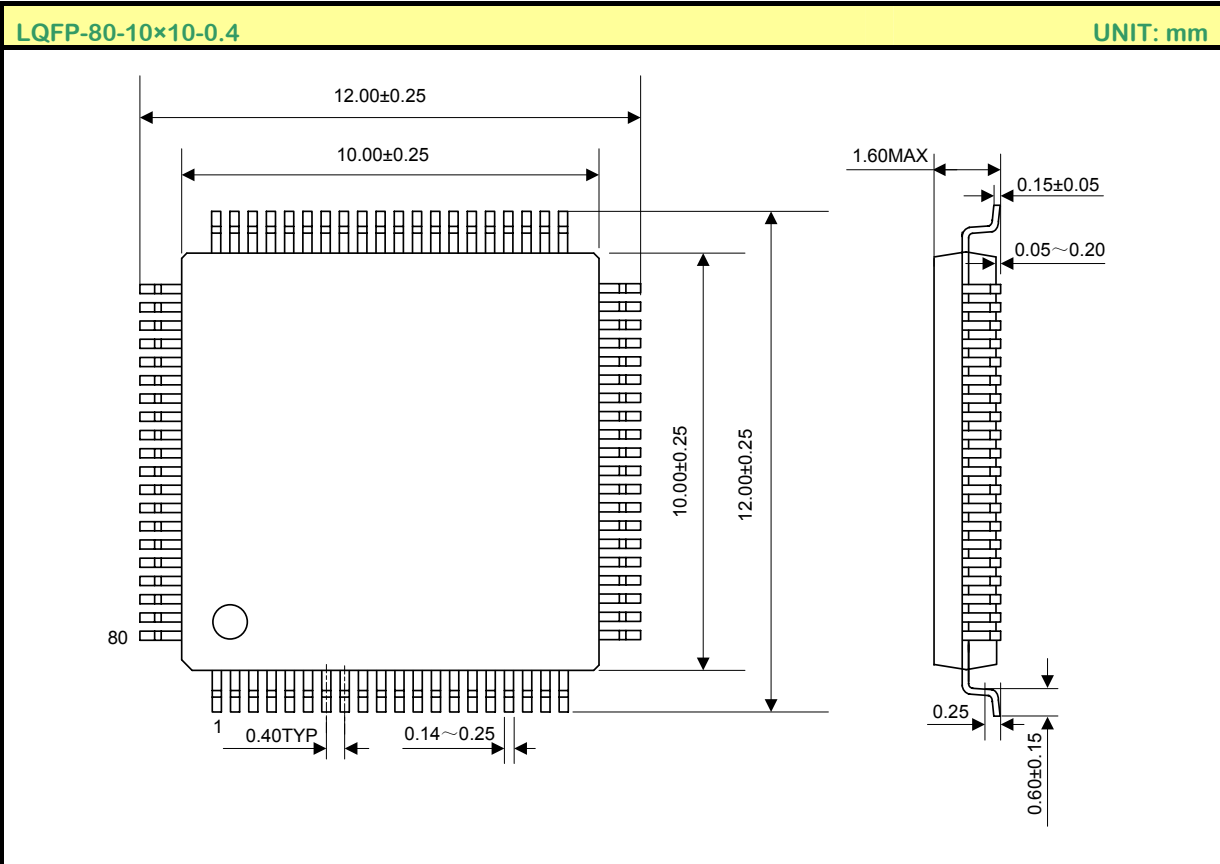

**MOS DEVICES OPERATE NOTES:**

Electrostatic charges may exist in many things. Please take following preventive measures to prevent effectively the MOS electric circuit as a result of the damage which is caused by discharge:

- The operator must put on wrist strap which should be earthed to against electrostatic.
- Equipment cases should be earthed.
- All tools used during assembly, including soldering tools and solder baths, must be earthed.
- MOS devices should be packed in antistatic/conductive containers for transportation.

**Disclaimer:**

- Silan reserves the right to make changes to the information herein for the improvement of the design and performance without further notice!
- All semiconductor products malfunction or fail with some probability under special conditions. When using Silan products in system design or complete machine manufacturing, it is the responsibility of the buyer to comply with the safety standards strictly and take essential measures to avoid situations in which a malfunction or failure of such Silan products could cause loss of body injury or damage to property.
- Silan will supply the best possible product for customers!