

THYRISTOR MODULE

SCA (SCE) 160AA

UL: E76102 (M)

SCA (SCE) 160AA

《Advantages》

- Isolated package
- di/dt 200A/μs
- dv/dt 1000V/μs
- IT(AV) 160A, IT(RMS) 251A, ITSM 5400A

《Applications》

- Various rectifiers, motor drives, Heater controls, and power supplies

《特長》

- 絶縁型パッケージ
- di/dt 200A/μs
- dv/dt 1000V/μs
- IT(AV) 160A, IT(RMS) 251A, ITSM 5400A

《用途》

- 整流器、モーター制御、ヒーター制御、各種電源装置

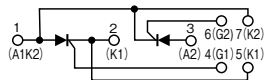

SCA

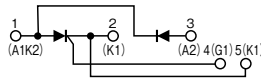

SCE

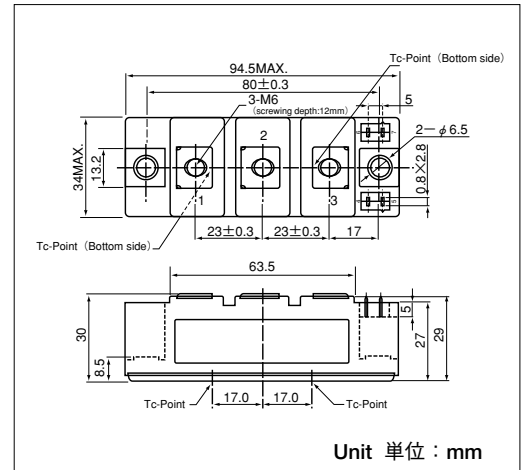

Unit 単位 : mm

■ Maximum Ratings 最大定格

(Unless otherwise specified Tj=25°C / 指定なき場合はTj=25°Cとする)

Symbol 記号	Item 項目	Ratings 定格値			Unit 単位
		SCA160AA80 SCE160AA80	SCA160AA160 SCE160AA160	SCA160AA180 SCE160AA180	
V _{RRM}	*Repetitive Peak Reverse Voltage * 定格ピーク繰返し逆電圧	800	1600	1800	V
V _{RSM}	*Non-Repetitive Peak Reverse Voltage * 定格ピーク非繰返し逆電圧	960	1700	1900	V
V _{DRM}	Repetitive Peak Off-state Voltage 定格ピーク繰返しオフ電圧	800	1600	1800	V

Symbol 記号	Item 項目	Conditions 条件	Ratings 定格値	Unit 単位
I _{T(AV)} I _{F(AV)}	*Average On-state (Forward) Current * 定格平均オン (順) 電流	Single phase, half wave, 180° conduction, T _c =88°C 単相半波平均値180° 導通角	160	A
I _{T(RMS)} I _{F(RMS)}	*R.M.S. On-state (Forward) Current * 定格実効オン (順) 電流	Single phase, half wave, 180° conduction, T _c =88°C 単相半波実効値180° 導通角	251	A
I _{TSM} I _{FSM}	*Surge On-state (Forward) Current * 定格サージオン (順) 電流	½cycle, 50/60Hz, Peak value, non-repetitive 50/60Hz 商用単相半波 1サイクル波高値 非繰返し	5400/5900	A
I ² t	*I ² t * 電流二乗時間積	Value for one cycle surge current 定格サージオン電流に対する値	145000	A ² s
P _{GM}	Peak Gate Power Dissipation 定格ピークゲート損失		10	W
P _{G(AV)}	Average Gate Power Dissipation 定格平均ゲート損失		3	W
I _{FGM}	Peak Gate Current 定格ピークゲート順電流		3	A
V _{FGM}	Peak Gate Voltage (Forward) 定格ピークゲート順電圧		10	V
V _{RGM}	Peak Gate Voltage (Reverse) 定格ピークゲート逆電圧		5	V
di/dt	Critical Rate of Rise of On-state Current 定格臨界オン電流上昇率	I _G =100mA, V _D =½V _{DRM} , di _G /dt=0.1A/μs	200	A/μs
V _{ISO}	*Isolation Breakdown Voltage * 絶縁耐圧	A.C. 1minute 実効値, A.C. 1分間	3000	V
T _j	*Operating Junction Temperature * 定格接合部温度		-40~+125	°C
T _{stg}	*Storage Temperature * 保存温度		-40~+125	°C
Mounting Torque 締付トルク	Mount (M6) 取付	Recommended value 推奨値 2.5~3.9N・m	4.7	N・m
	Terminal (M6) 主端子	Recommended value 推奨値 2.5~3.9N・m	4.7	
Mass 質量		Typical value 標準値	210	g

■Electrical Characteristics 電気的特性

(Unless otherwise specified Tj=25°C / 指定なき場合はTj=25°Cとする)

Symbol 記号	Item 項目	Conditions 条件	Ratings 定格値	Unit 単位
I _{DRM}	Repetitive Peak Off-state Current, max 最大オフ電流	Tj=125°C, V _D =V _{DRM}	100	mA
I _{RRM}	*Repetitive Peak Reverse Current, max *最大逆電流	Tj=125°C, V _R =V _{RRM}	100	mA
V _{TM} V _{FM}	*On-state (Forward) Voltage, max *最大オン(順)電圧	I _T =500A	1.4	V
V _{T(VO)}	*Threshold Voltage, max *最大閾値電圧	Tj=25°C	1.0	V
		Tj=125°C	0.85	
r _t	*Dynamic Resistance, max *最大オン抵抗	Tj=25°C	1.0	mΩ
		Tj=125°C	1.3	
I _{GT}	Gate Trigger Current, max 最大ゲートトリガ電流	V _D =6V, I _T =1A	100	mA
V _{GT}	Gate Trigger Voltage, max 最大ゲートトリガ電圧	V _D =6V, I _T =1A	3	V
V _{GD}	Gate Non-Trigger Voltage, min 最小ゲート非トリガ電圧	Tj=125°C, V _D =½V _{DRM}	0.25	V
dv/dt	Critical Rate of Rise of Off-state Voltage, min 最小臨界オフ電圧上昇率	Tj=125°C, V _D =⅔V _{DRM} , exp. waveform	1000	V/μs
R _{th(j-c)}	*Thermal Impedance, max *最大熱抵抗	cont., Junction to case, per one element 接合部—ケース間 cont., 単位エレメント当り	0.17	°C/W
R _{th(j-c)}	*Effective Thermal Impedance, max *最大実効熱抵抗	sin.180°, Junction to case, per one element 接合部—ケース間, sin.180°, 単位エレメント当り	0.18	°C/W
		rec.120°, Junction to case, per one element 接合部—ケース間, rec.120°, 単位エレメント当り	0.19	
R _{th(c-s)}	*Interface Thermal Impedance, max *最大接触熱抵抗	Case to Heat sink, per one element ケース—ヒートシンク間, 単位エレメント当り Thermal conductivity (Silicon grease)=7×10 ⁻³ [W/cm·°C] シリコングリスの熱伝導率=7×10 ⁻³ [W/cm·°C]	0.1	°C/W

*mark: Thyristor and Diode part, No mark: Thyristor part.

注) 上表中*印の項目は、サイリスタ部及びダイオード部の両方に適用します。その他の項目は主にサイリスタ部に適用します。

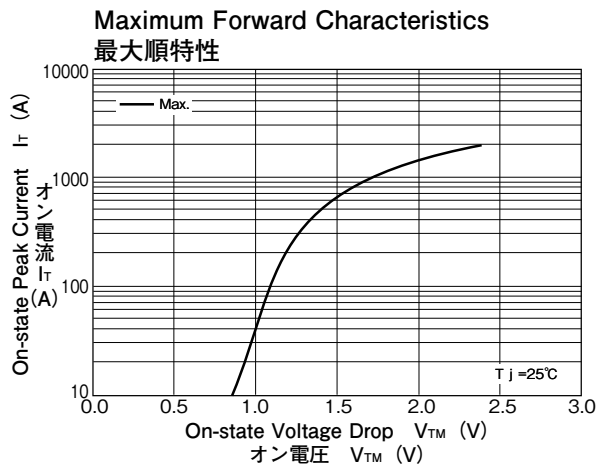
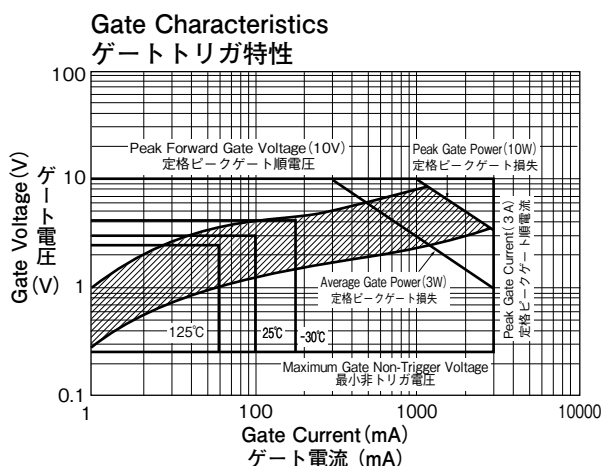

Surge Forward Current Rating (Non-Repetitive)

サージ順電流耐量 (非繰返し)

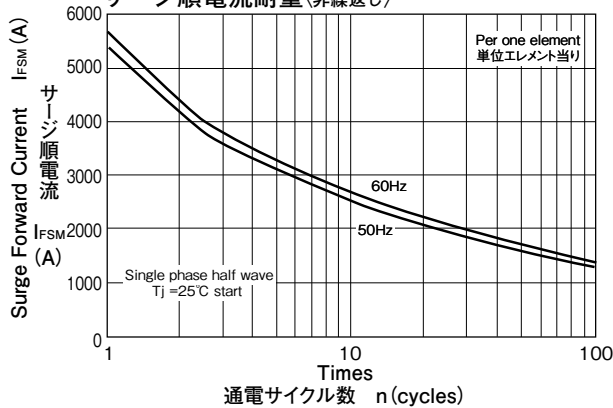

Transient Thermal Impedance

過渡熱インピーダンス特性

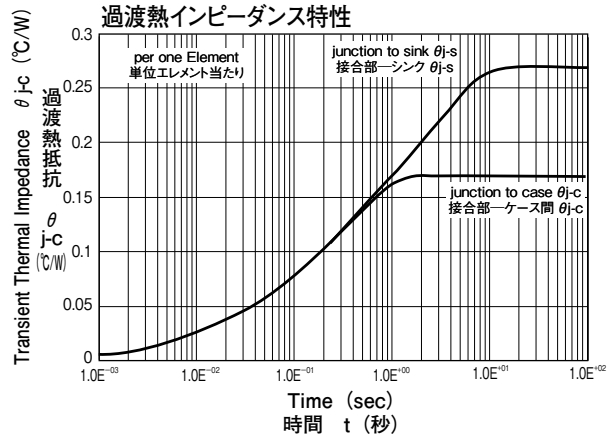

Current vs Power Dissipation

最大電力損失特性

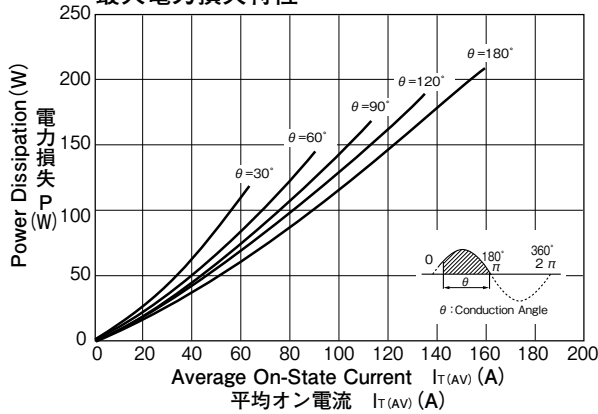

Current vs Allowable Case Temperature

電流対最大許容ケース温度

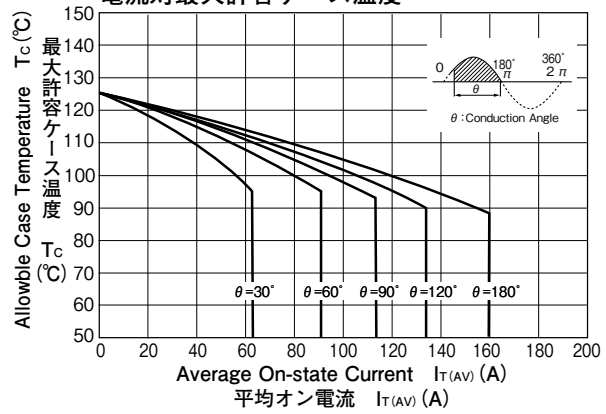

Output Current (W1; Bidirectional connection)

許容出力電流 (W1; 逆並列接続)

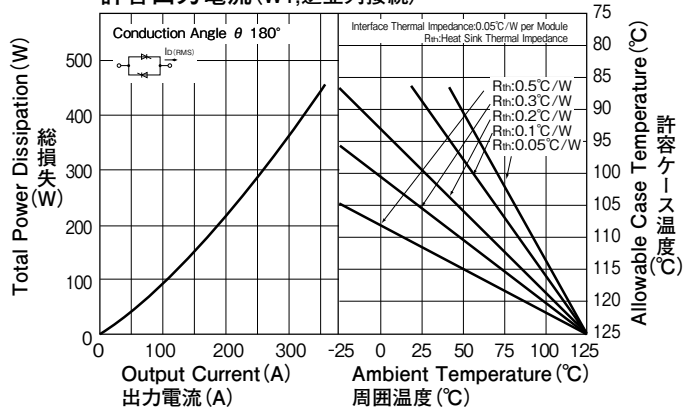

Output Current (B2; Two pulse bridge connection)

許容出力電流 (B2; 単相ブリッジ接続)

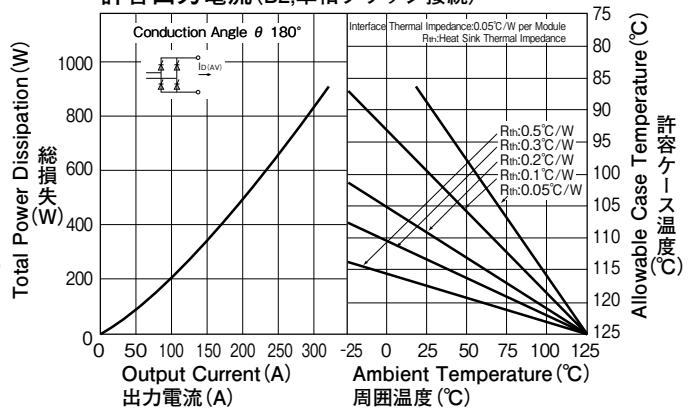

Output Current

(B6; Six pulse bridge connection, W3; Three phase bidirectional connection)

許容出力電流 (B6; 三相ブリッジ接続, W3; 三相逆並列接続)

