

Service  
**Service**

# Service Manual

# SET BLOCK DIAGRAM

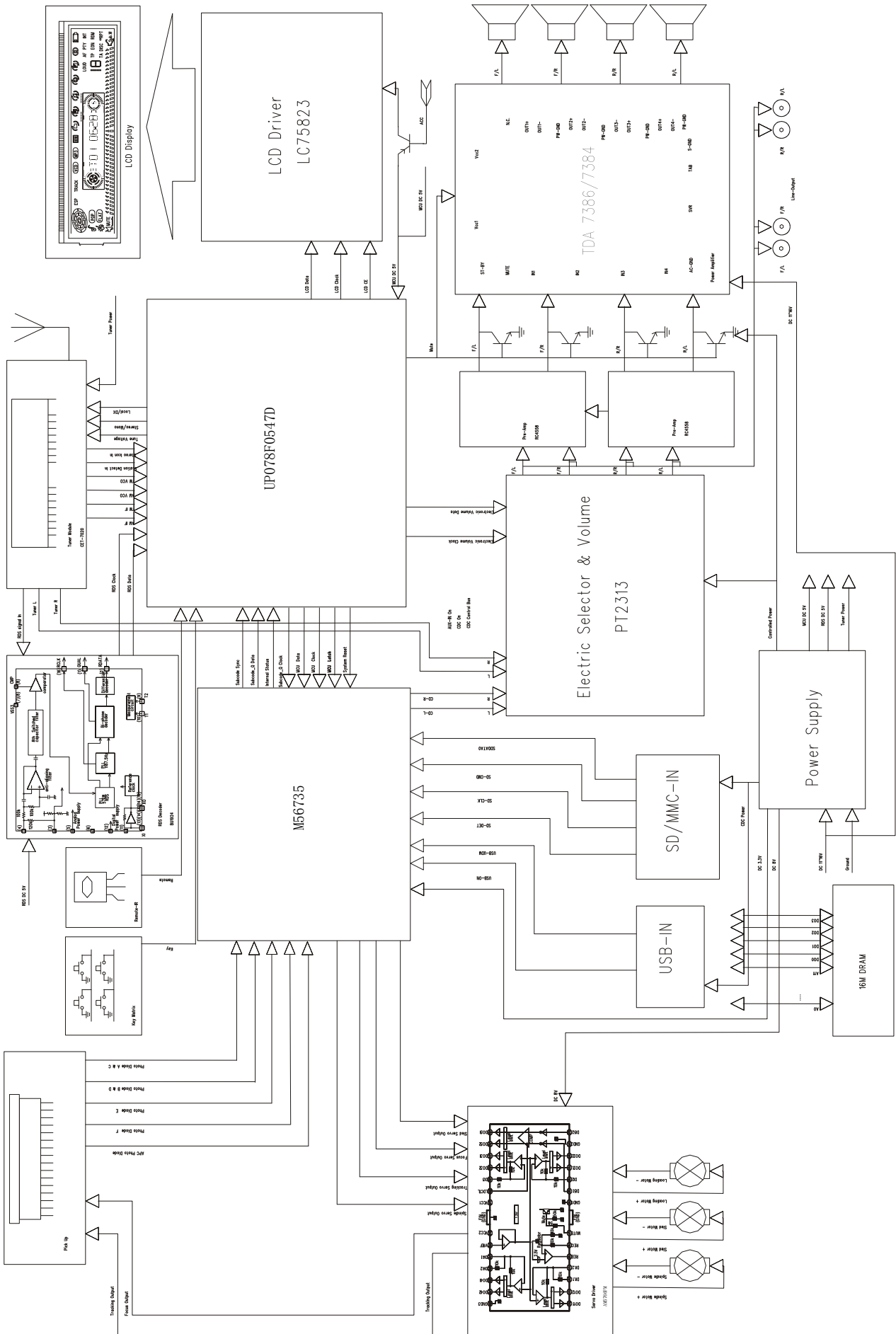

# SET WIRING DIAGRAM

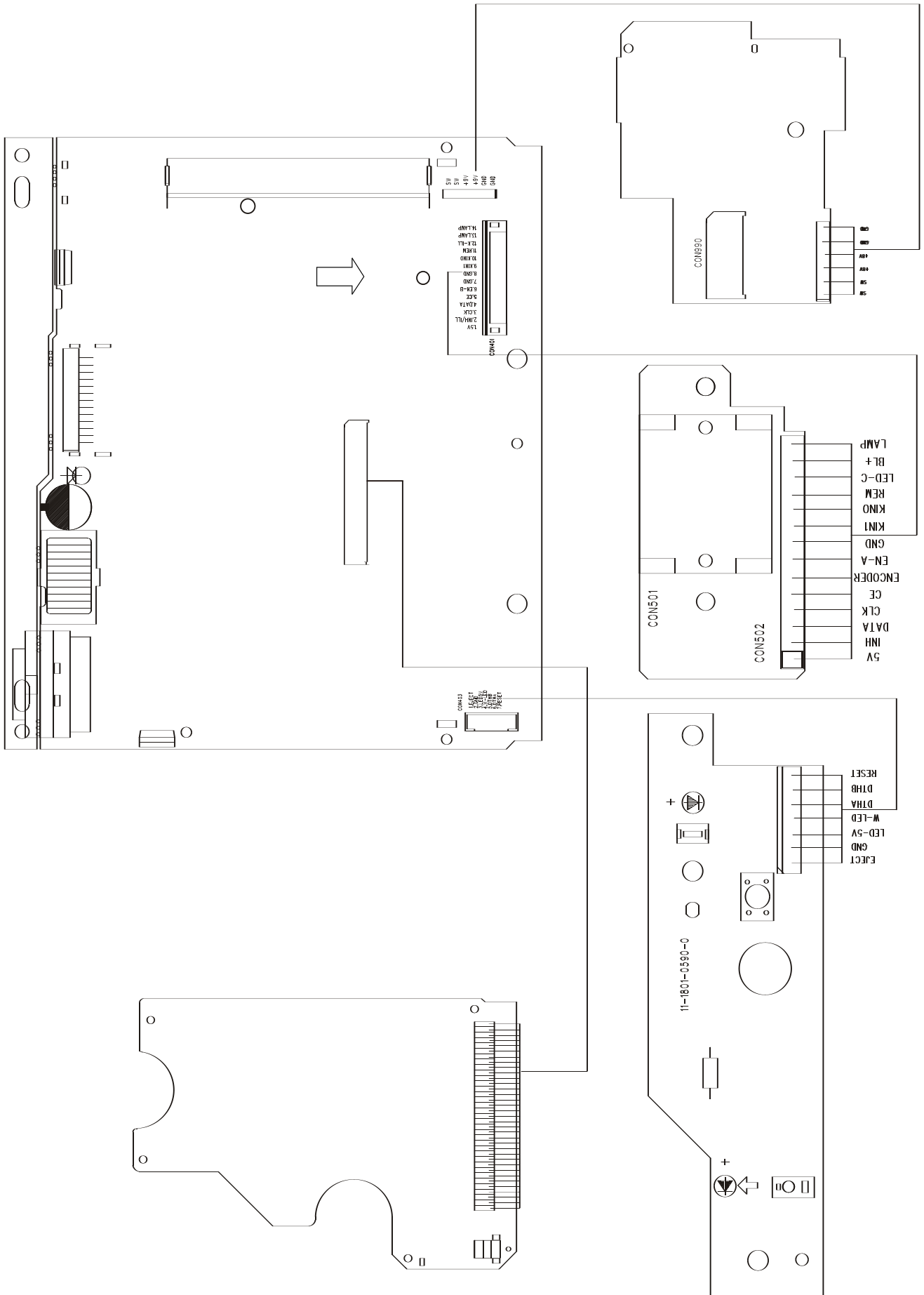

# MAIN BOARD - CIRCUIT DIAGRAM

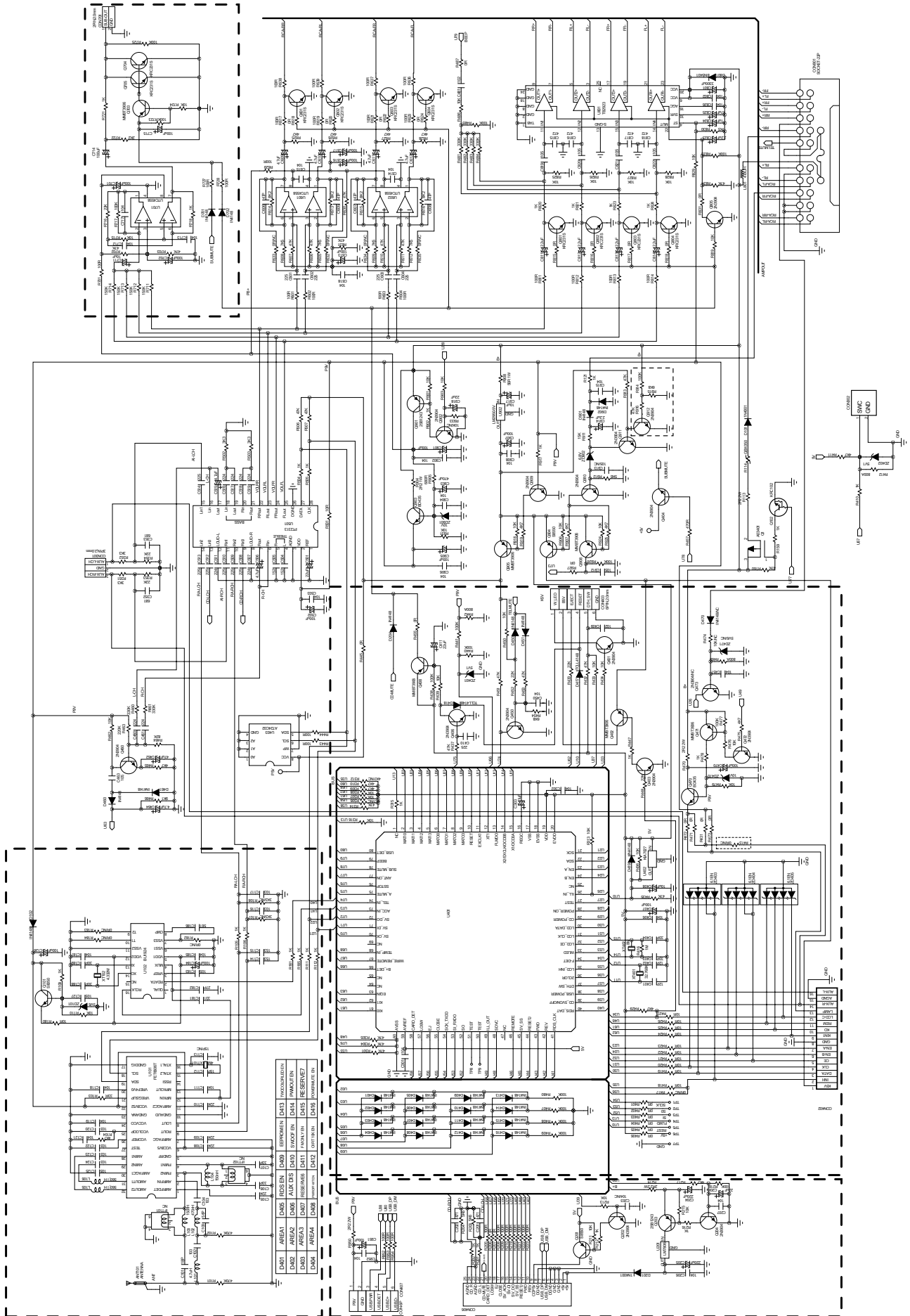

# MAIN BOARD - PCB LAYOUT TOP VIEW

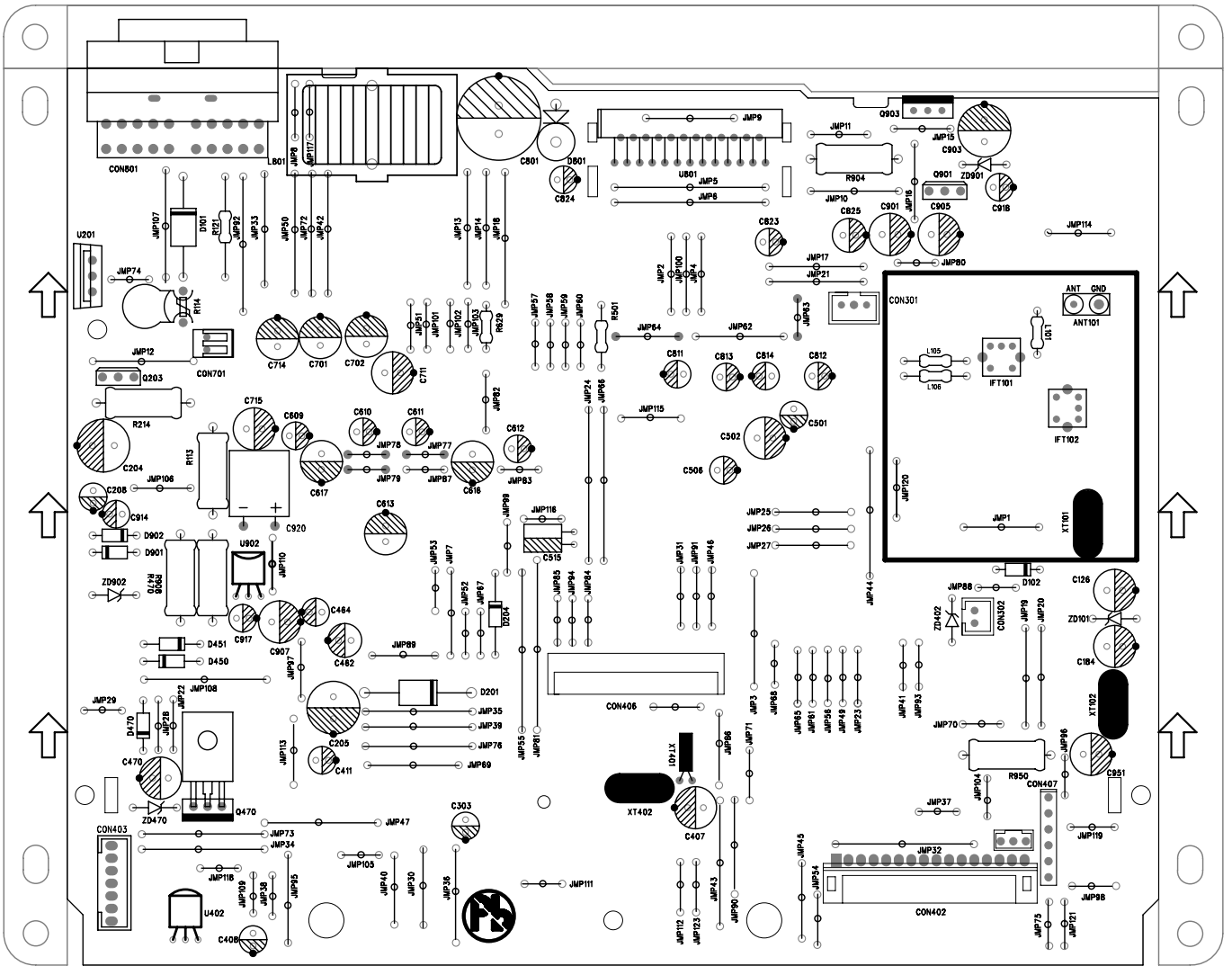

MAIN BOARD - PCB LAYOUT BOTTOM VIEW

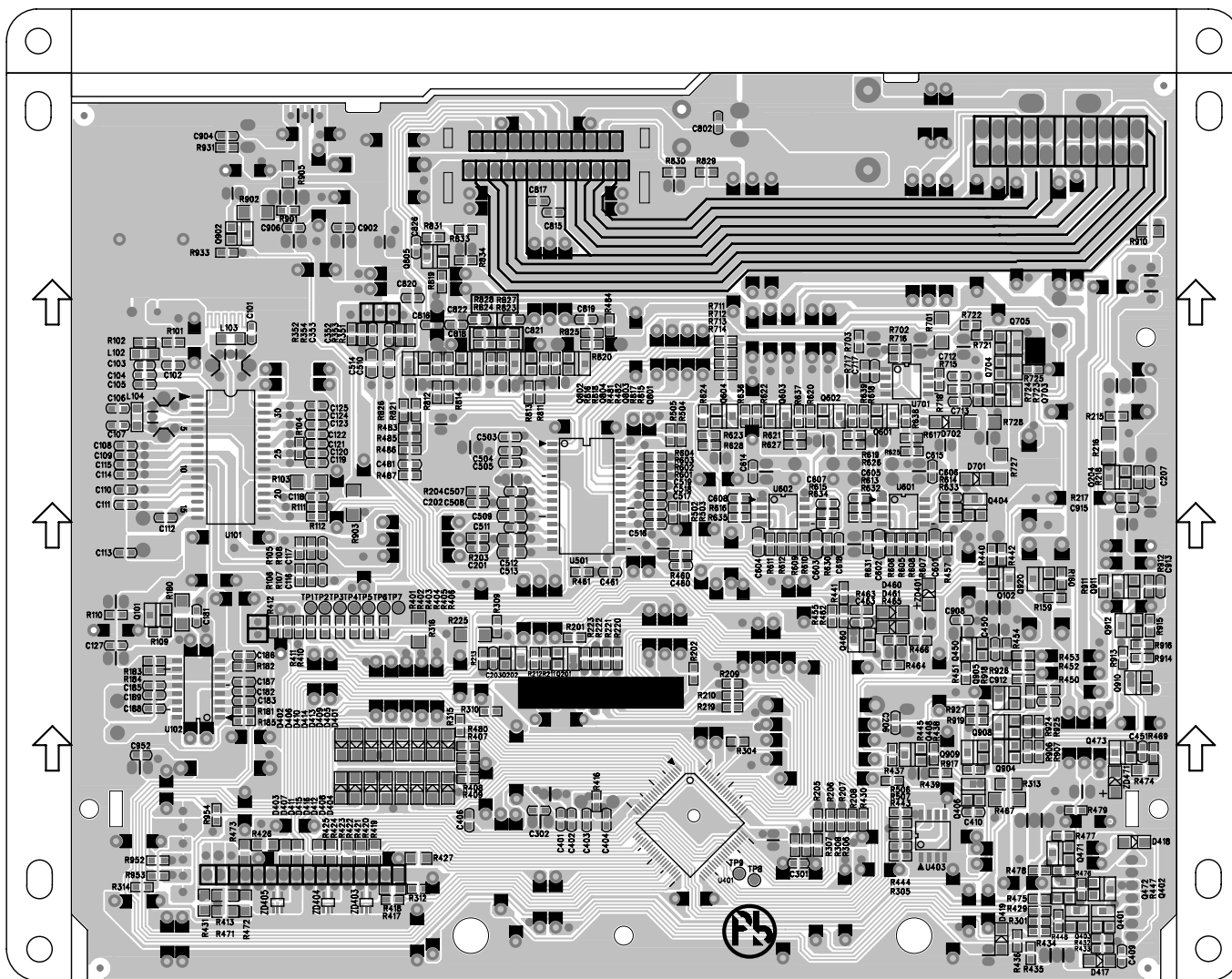

# SERVO BOARD - CIRCUIT DIAGRAM

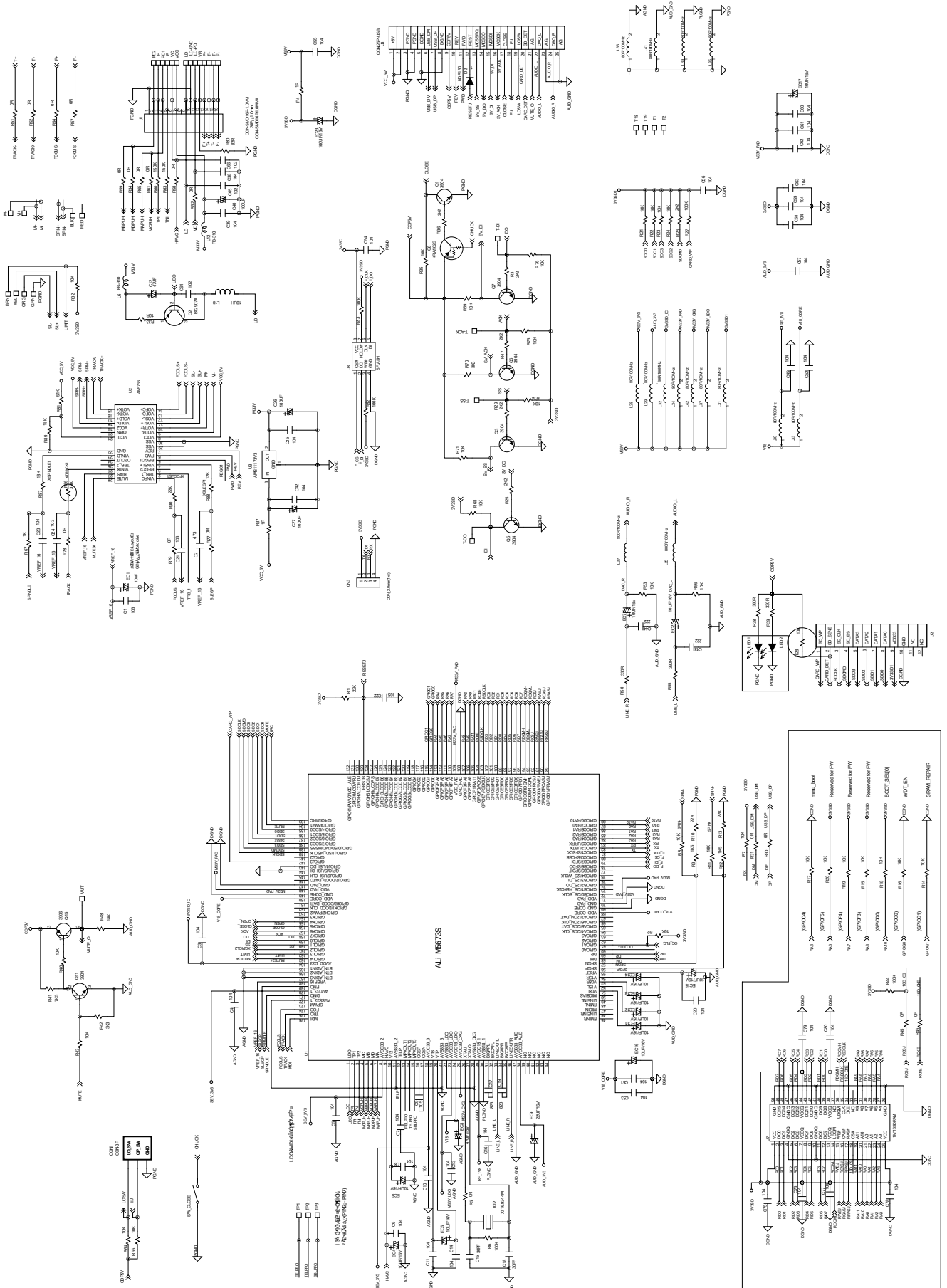

# SERVO BOARD - LAYOUT DIAGRAM TOP VIEW

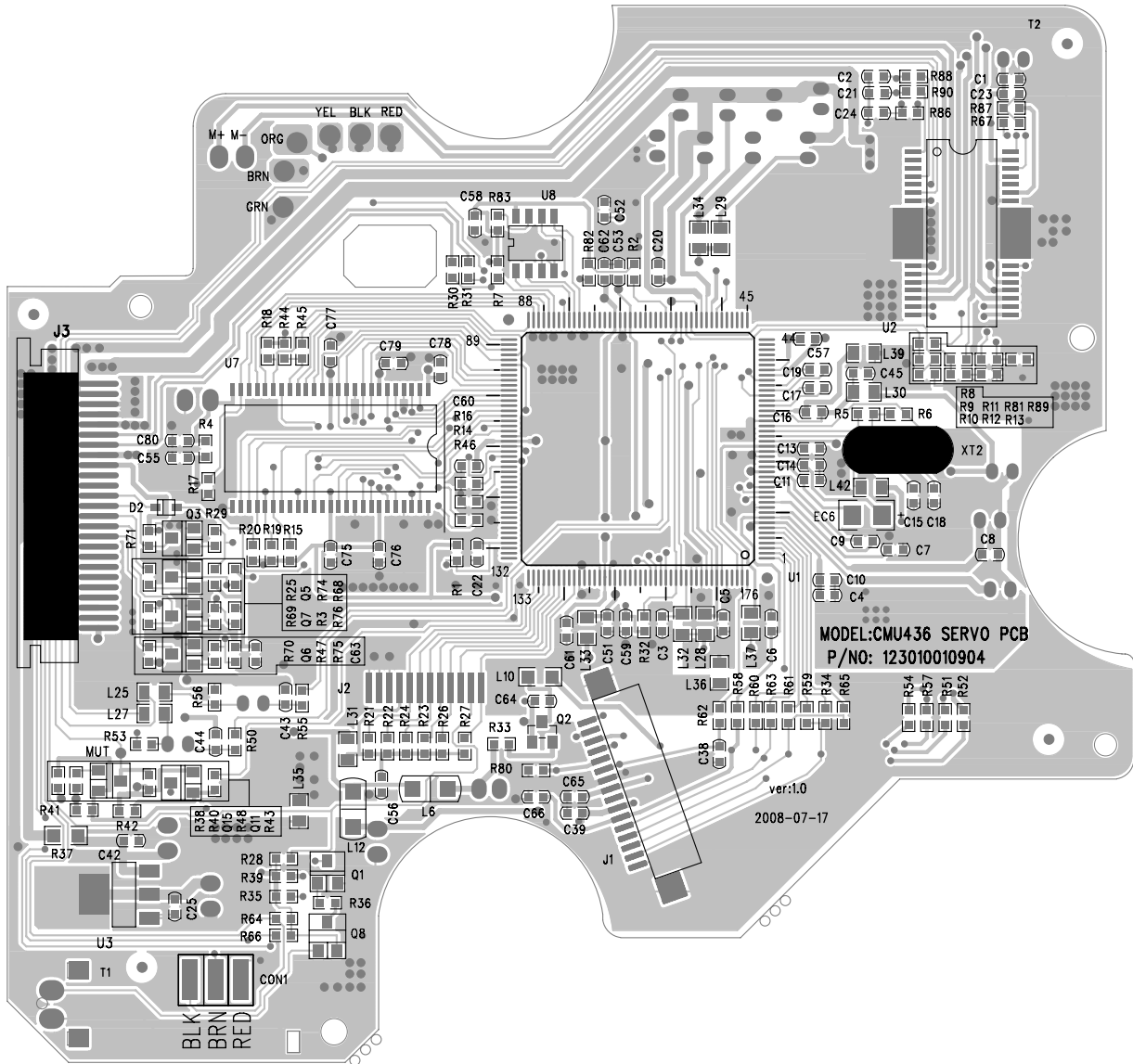



# SERVO BOARD - LAYOUT DIAGRAM BOTTOM VIEW

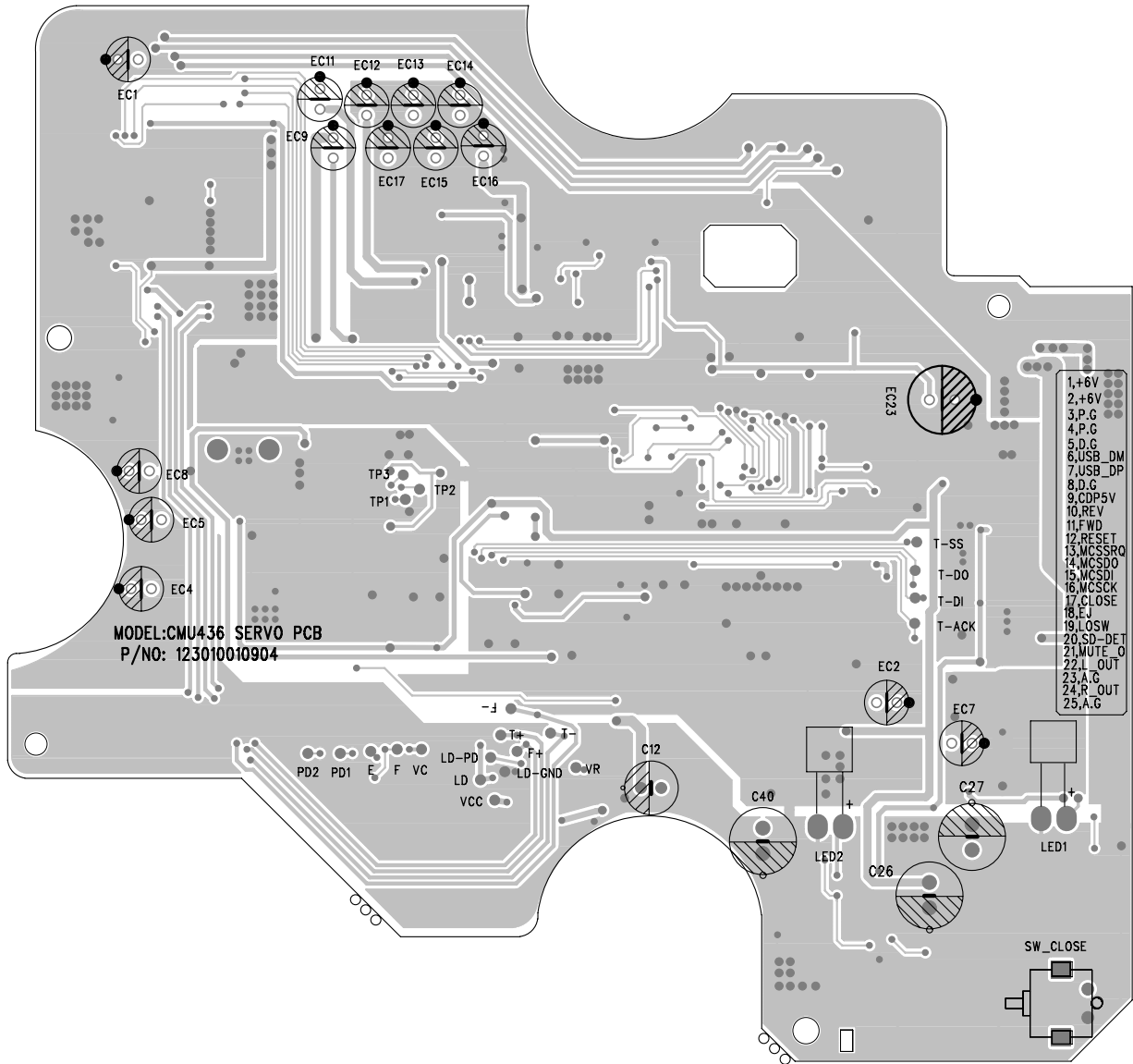

# KB BOARD - CIRCUIT DIAGRAM

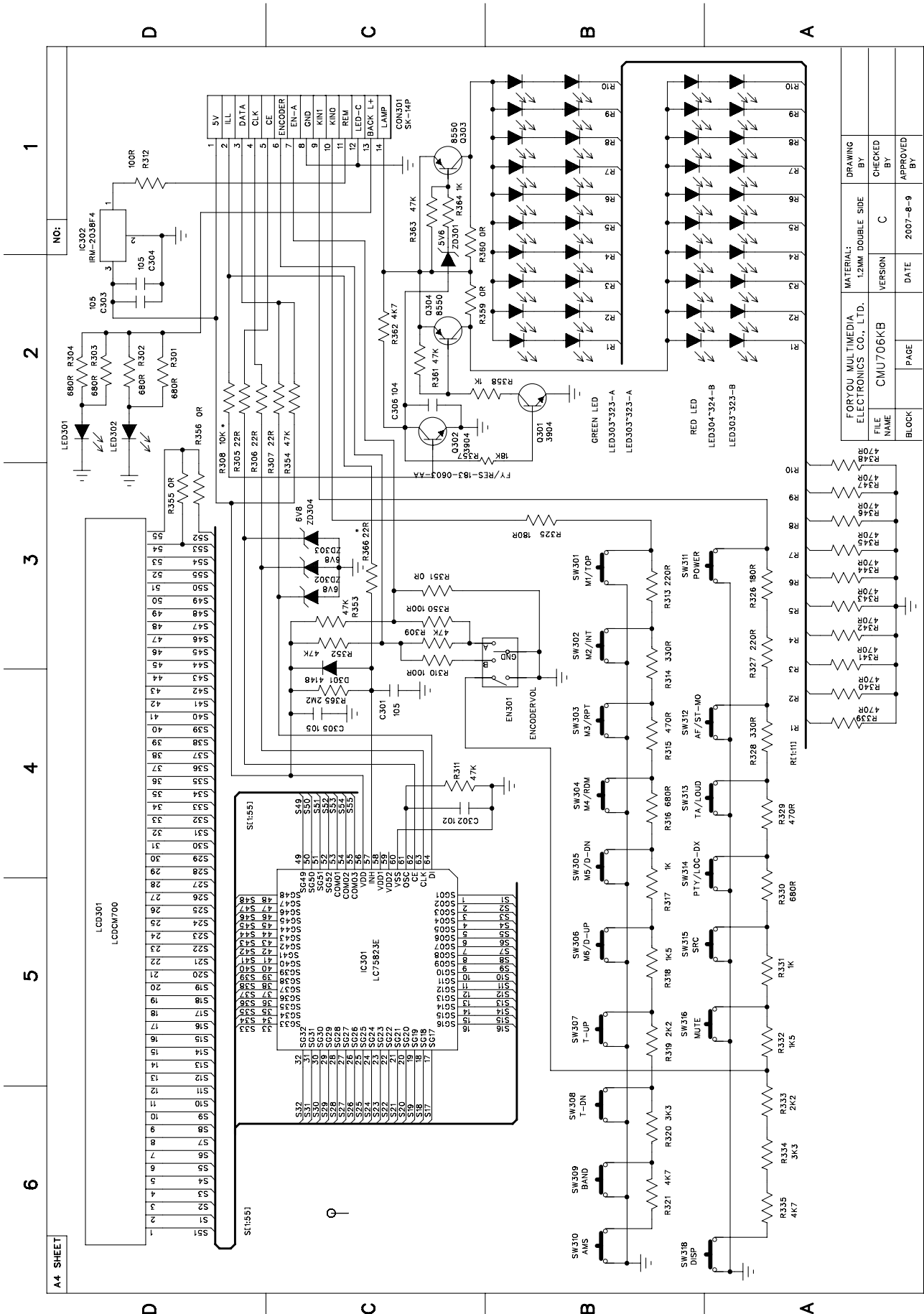

DRAWING BY		MATERIAL: L2MM DOUBLE SIDE	
CHECKED BY		VERSION C	
FILE NAME		CMU706KB	
BLOCK	PAGE	DATE	APPROVED BY
		2007-8-9	

OR.P0E01

# KB BOARD - LAYOUT DIAGRAM TOP VIEW

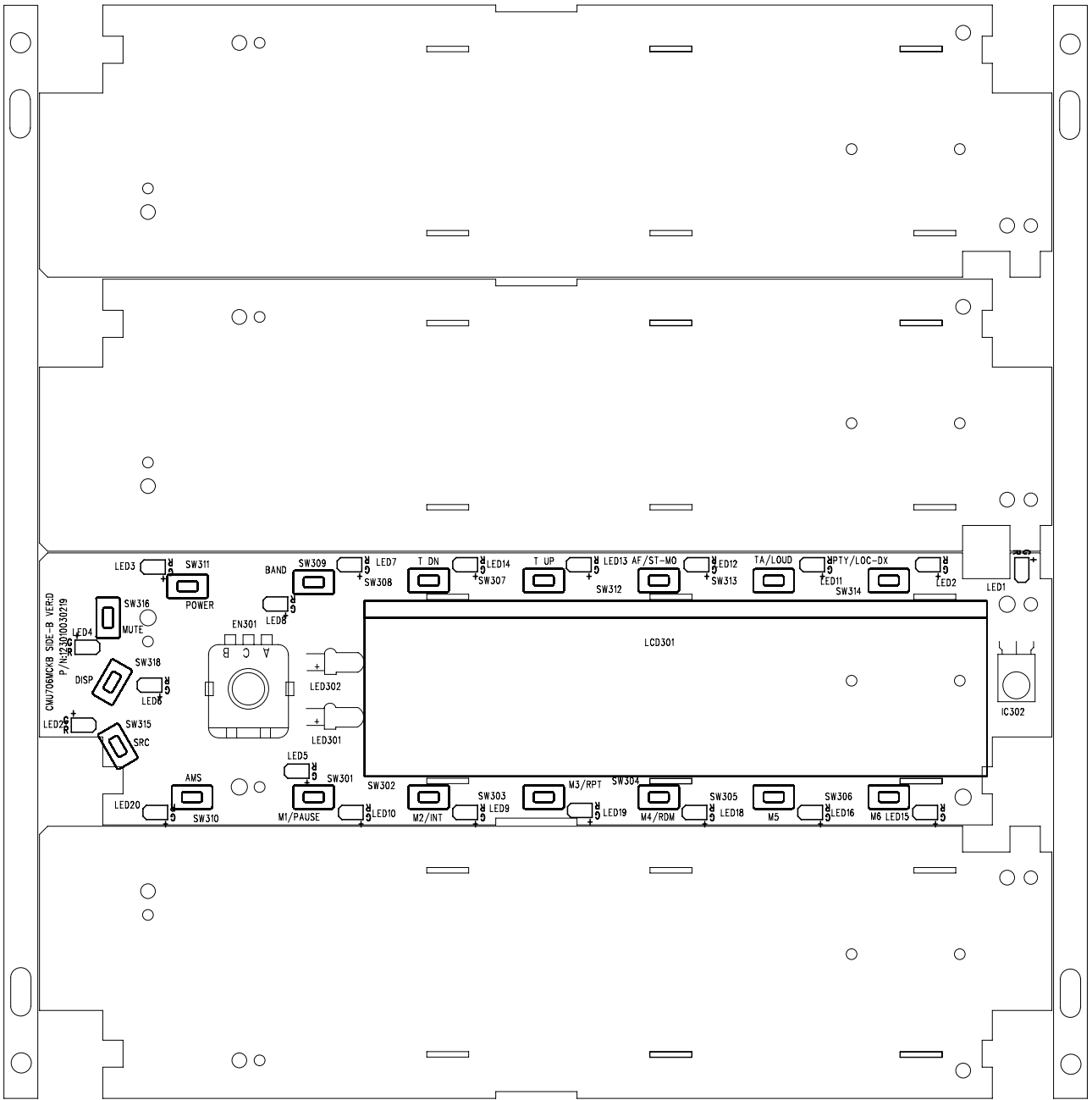

# KB BOARD - LAYOUT DIAGRAM BOTTOM VIEW

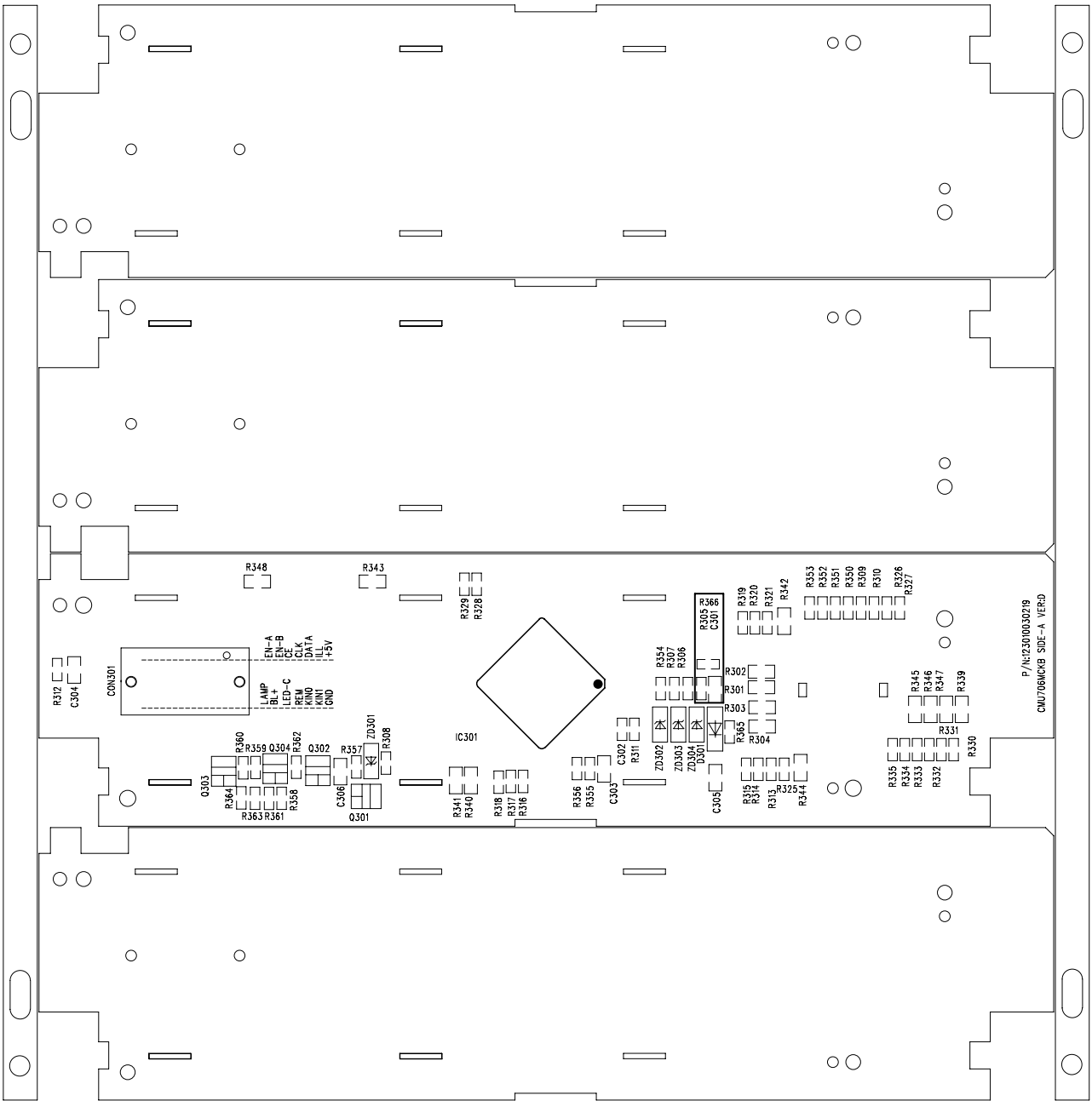

# FRONT BOARD - CLAYOUT DIAGRAM

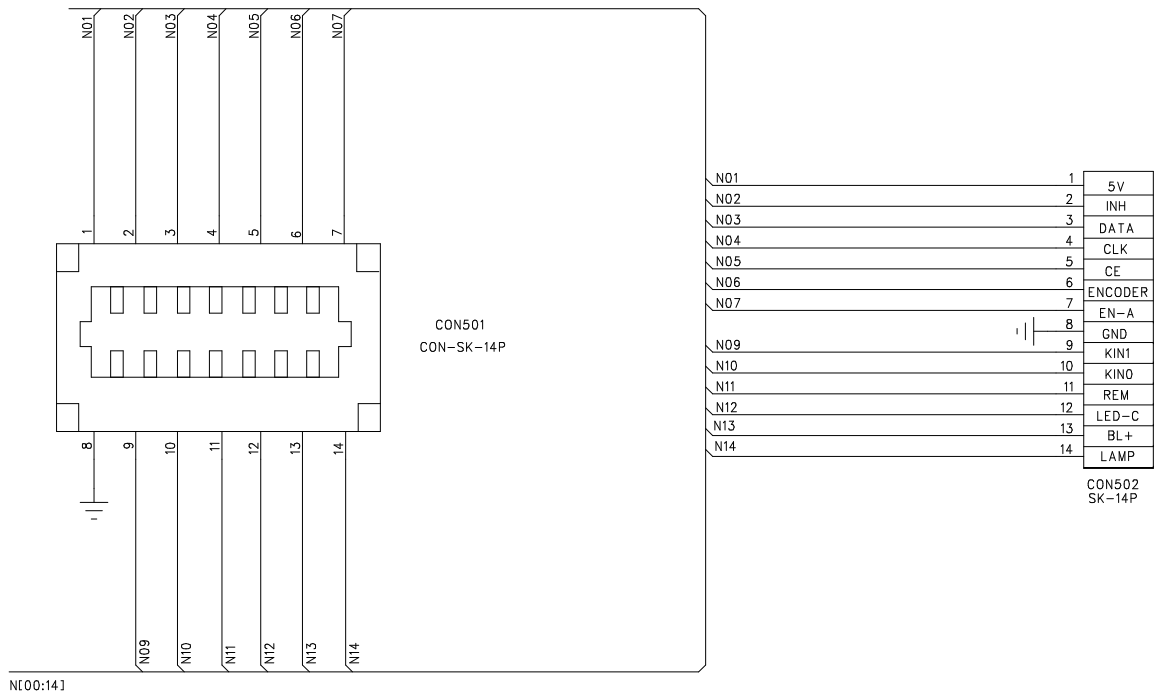

# FRONT BOARD - LAYOUT DIAGRAM TOP/BOTTOM VIEW

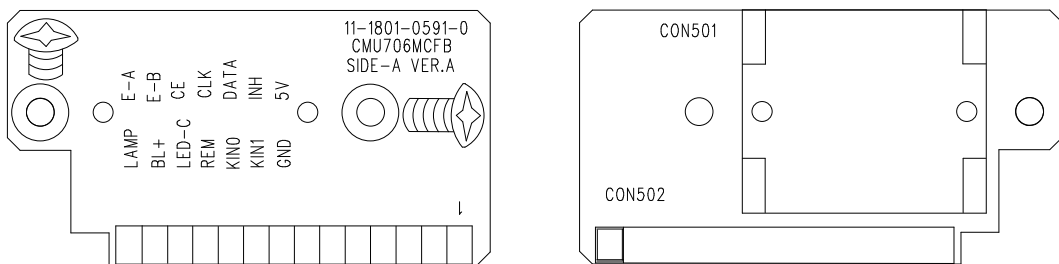

# CONNECTOR BOARD - CLAYOUT DIAGRAM

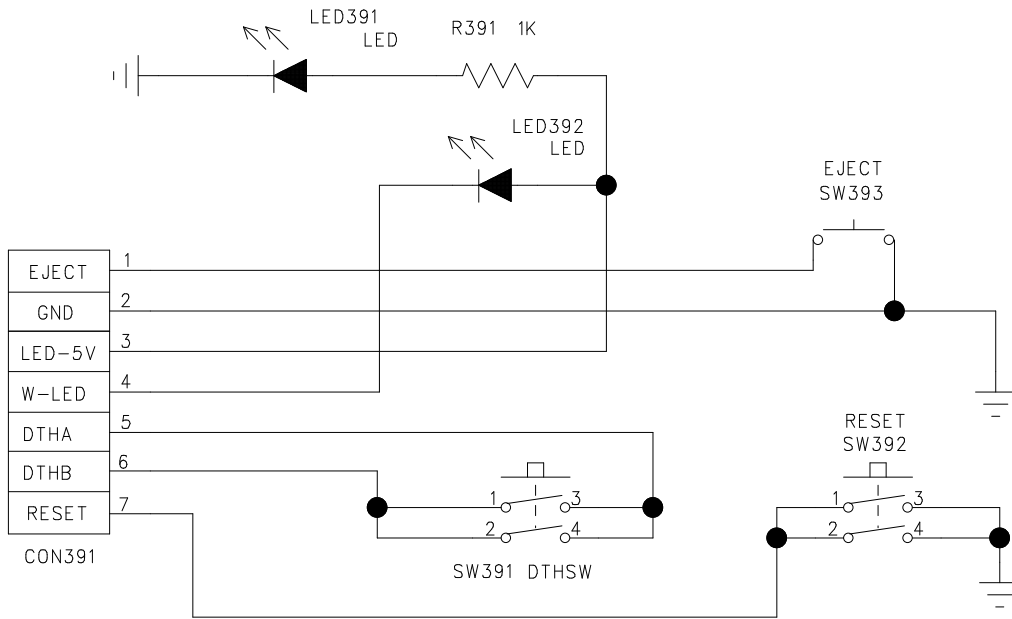

# CONNECTOR BOARD - LAYOUT DIAGRAM TOP/BOTTOM VIEW

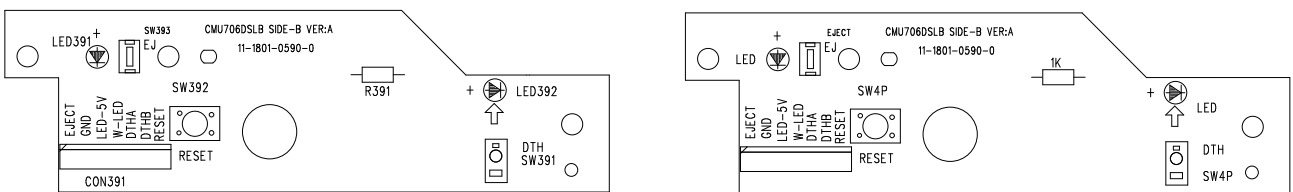

# USB BOARD - CLAYOUT DIAGRAM

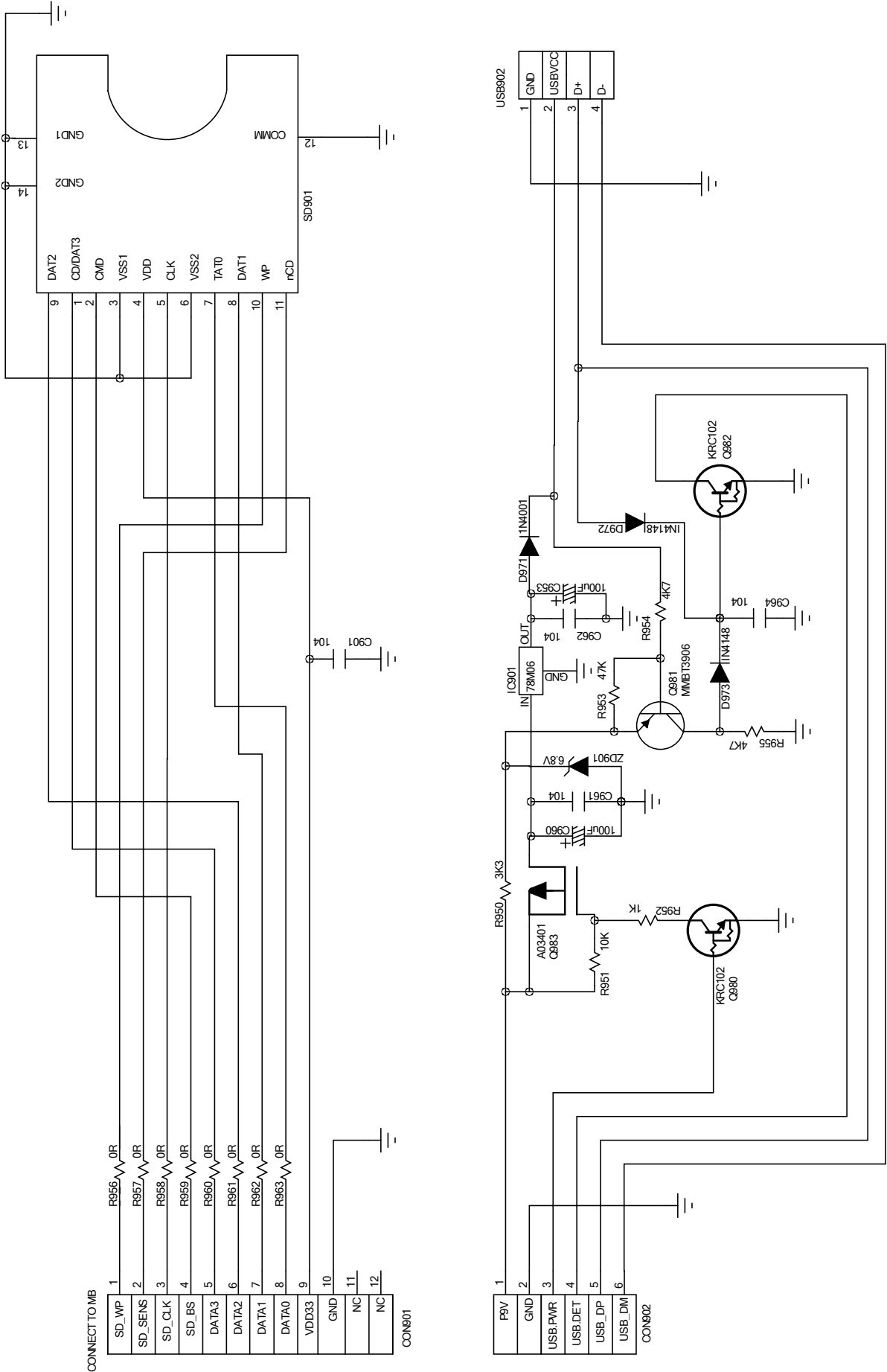

# USB BOARD - LAYOUT DIAGRAM TOP VIEW

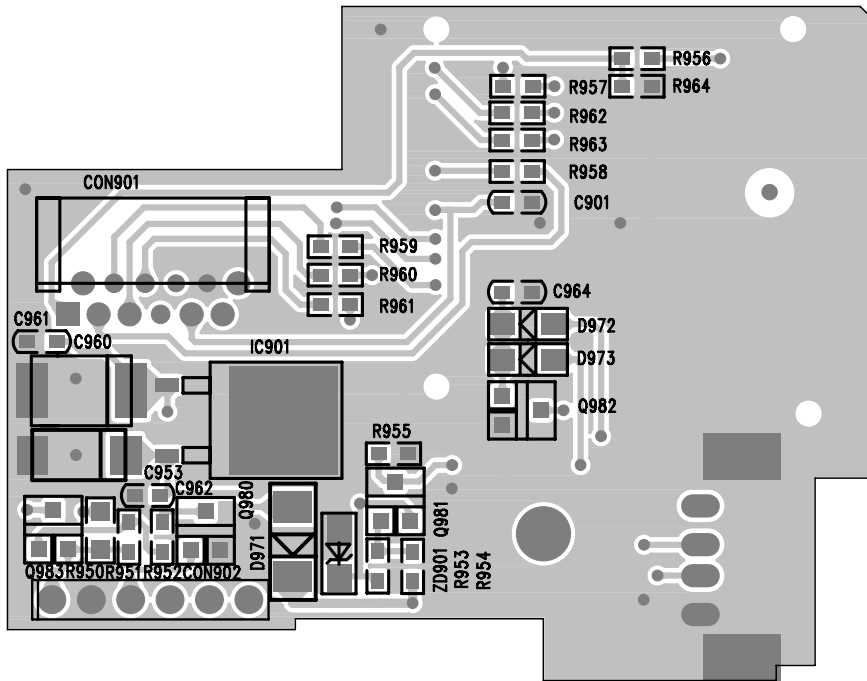

# USB BOARD - LAYOUT DIAGRAM BOTTOM VIEW

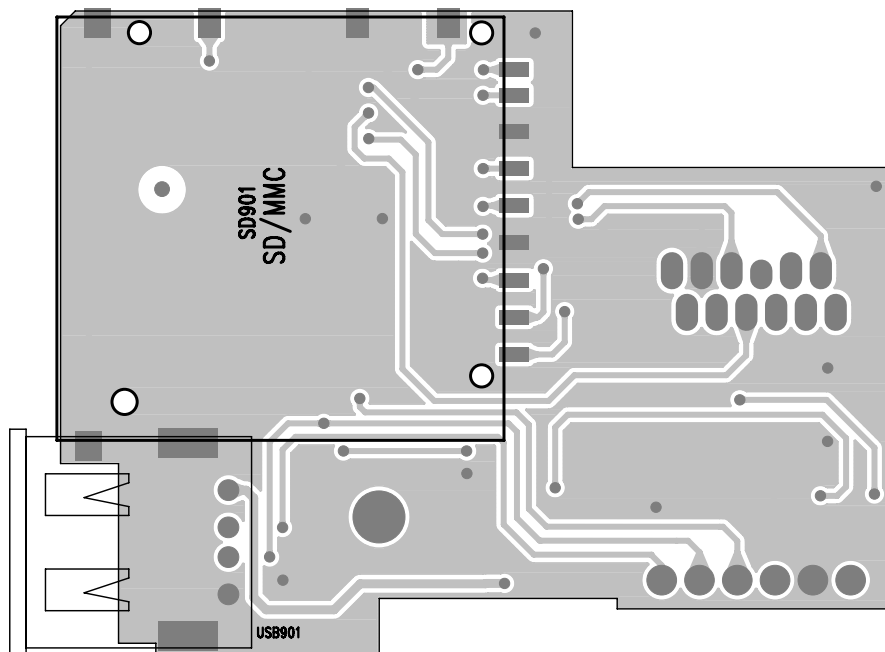



# EXPLODED VIEW - MAIN UNIT

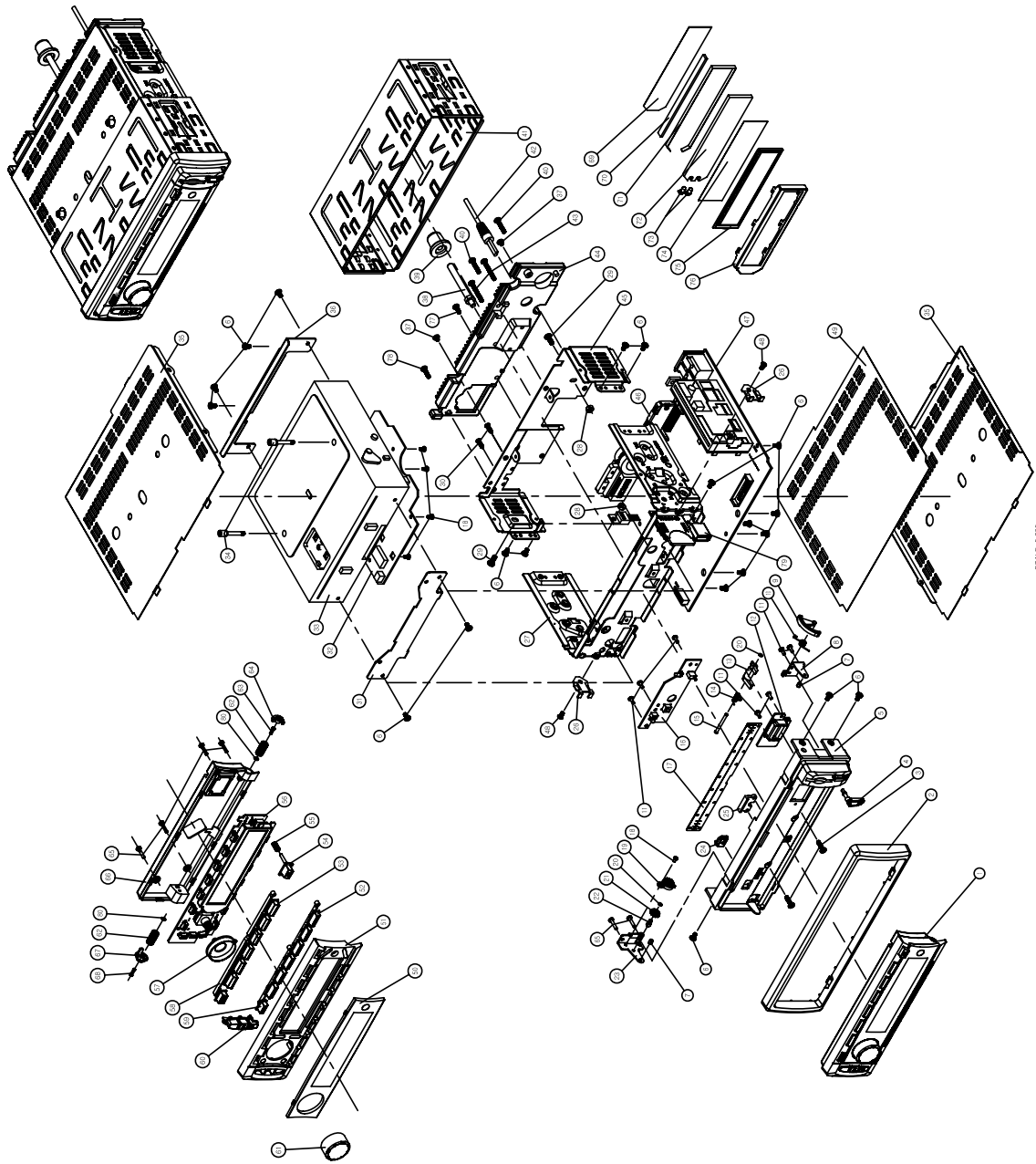

Part No.	Part Name	Quantity	Material	Part No.	Description
1	FRONT PANEL	1	ALUMINUM	1	FRONT PANEL
2	TOP COVER	1	ALUMINUM	2	TOP COVER
3	INTERNAL CHASSIS	1	ALUMINUM	3	INTERNAL CHASSIS
4	CONTROL PANEL	1	ALUMINUM	4	CONTROL PANEL
5	INTERNAL COMPONENTS	1	ALUMINUM	5	INTERNAL COMPONENTS
6	TERMINAL BLOCKS	1	ALUMINUM	6	TERMINAL BLOCKS
7	BACK PANEL	1	ALUMINUM	7	BACK PANEL
8	BOTTOM COVER	1	ALUMINUM	8	BOTTOM COVER
9	SCREW	1	STEEL	9	SCREW
10	SCREW	1	STEEL	10	SCREW
11	SCREW	1	STEEL	11	SCREW
12	SCREW	1	STEEL	12	SCREW
13	SCREW	1	STEEL	13	SCREW
14	SCREW	1	STEEL	14	SCREW
15	SCREW	1	STEEL	15	SCREW
16	SCREW	1	STEEL	16	SCREW
17	SCREW	1	STEEL	17	SCREW
18	SCREW	1	STEEL	18	SCREW
19	SCREW	1	STEEL	19	SCREW
20	SCREW	1	STEEL	20	SCREW
21	TERMINAL BLOCK	1	ALUMINUM	21	TERMINAL BLOCK
22	TERMINAL BLOCK	1	ALUMINUM	22	TERMINAL BLOCK
23	TERMINAL BLOCK	1	ALUMINUM	23	TERMINAL BLOCK
24	TERMINAL BLOCK	1	ALUMINUM	24	TERMINAL BLOCK
25	TERMINAL BLOCK	1	ALUMINUM	25	TERMINAL BLOCK
26	TERMINAL BLOCK	1	ALUMINUM	26	TERMINAL BLOCK
27	TERMINAL BLOCK	1	ALUMINUM	27	TERMINAL BLOCK
28	TERMINAL BLOCK	1	ALUMINUM	28	TERMINAL BLOCK
29	TERMINAL BLOCK	1	ALUMINUM	29	TERMINAL BLOCK
30	TERMINAL BLOCK	1	ALUMINUM	30	TERMINAL BLOCK
31	BACK PANEL	1	ALUMINUM	31	BACK PANEL
32	BOTTOM COVER	1	ALUMINUM	32	BOTTOM COVER
33	SCREW	1	STEEL	33	SCREW
34	SCREW	1	STEEL	34	SCREW
35	SCREW	1	STEEL	35	SCREW
36	SCREW	1	STEEL	36	SCREW
37	SCREW	1	STEEL	37	SCREW
38	SCREW	1	STEEL	38	SCREW
39	SCREW	1	STEEL	39	SCREW
40	SCREW	1	STEEL	40	SCREW
41	SCREW	1	STEEL	41	SCREW
42	SCREW	1	STEEL	42	SCREW
43	SCREW	1	STEEL	43	SCREW
44	SCREW	1	STEEL	44	SCREW
45	SCREW	1	STEEL	45	SCREW
46	SCREW	1	STEEL	46	SCREW
47	SCREW	1	STEEL	47	SCREW
48	SCREW	1	STEEL	48	SCREW
49	SCREW	1	STEEL	49	SCREW
50	SCREW	1	STEEL	50	SCREW
51	SCREW	1	STEEL	51	SCREW
52	SCREW	1	STEEL	52	SCREW
53	SCREW	1	STEEL	53	SCREW
54	SCREW	1	STEEL	54	SCREW
55	SCREW	1	STEEL	55	SCREW
56	SCREW	1	STEEL	56	SCREW
57	SCREW	1	STEEL	57	SCREW
58	SCREW	1	STEEL	58	SCREW
59	SCREW	1	STEEL	59	SCREW
60	SCREW	1	STEEL	60	SCREW
61	SCREW	1	STEEL	61	SCREW
62	SCREW	1	STEEL	62	SCREW
63	SCREW	1	STEEL	63	SCREW
64	SCREW	1	STEEL	64	SCREW
65	SCREW	1	STEEL	65	SCREW
66	SCREW	1	STEEL	66	SCREW
67	SCREW	1	STEEL	67	SCREW
68	SCREW	1	STEEL	68	SCREW
69	SCREW	1	STEEL	69	SCREW
70	SCREW	1	STEEL	70	SCREW
71	SCREW	1	STEEL	71	SCREW
72	SCREW	1	STEEL	72	SCREW
73	SCREW	1	STEEL	73	SCREW
74	SCREW	1	STEEL	74	SCREW
75	SCREW	1	STEEL	75	SCREW
76	SCREW	1	STEEL	76	SCREW
77	SCREW	1	STEEL	77	SCREW
78	SCREW	1	STEEL	78	SCREW
79	SCREW	1	STEEL	79	SCREW
80	SCREW	1	STEEL	80	SCREW
81	SCREW	1	STEEL	81	SCREW
82	SCREW	1	STEEL	82	SCREW
83	SCREW	1	STEEL	83	SCREW
84	SCREW	1	STEEL	84	SCREW
85	SCREW	1	STEEL	85	SCREW
86	SCREW	1	STEEL	86	SCREW
87	SCREW	1	STEEL	87	SCREW
88	SCREW	1	STEEL	88	SCREW

SCALE 0.800