

SCDS 103R/ 104R/ 105R

Shape and Dimensions

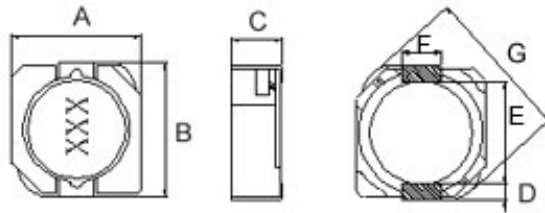

Dimensions in mm

TYPE	A	B	C	D	E	F	G
SCDS103R	10.3 ⁺⁰	10.5 ⁺⁰	3.1 ⁺⁰	1.2	7.7	3.0	13.5 ⁺⁰
SCDS104R	10.3 ⁺⁰	10.5 ⁺⁰	4 ⁺⁰	1.2	7.7	3.0	13.5 ⁺⁰
SCDS105R	10.3 ⁺⁰	10.5 ⁺⁰	5.1 ⁺⁰	1.2	7.7	3.0	13.5 ⁺⁰

Recommended Pattern

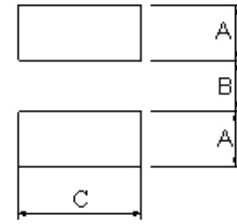

Dimension in mm

TYPE	A	B	C
SCDS103R	1.6	7.3	3.2
SCDS104R	1.6	7.3	3.2
SCDS105R	1.6	7.3	3.2

SCDS 124/125/127

Shape and Dimensions

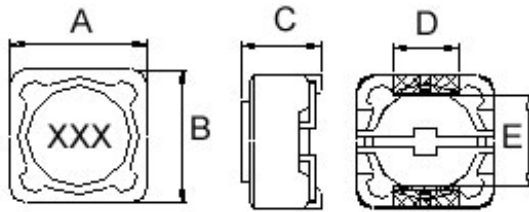

Dimensions in mm

TYPE	A	B	C	D	E
SCDS124	12.5 ⁺⁰	12.5 ⁺⁰	4.5 ⁺⁰	5	7.6
SCDS125	12.5 ⁺⁰	12.5 ⁺⁰	6 ⁺⁰	5	7.6
SCDS127	12.5 ⁺⁰	12.5 ⁺⁰	8 ⁺⁰	5	7.6

Recommended Pattern

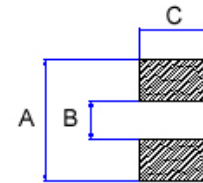

Dimensions in mm

TYPE	A	B	C
SCDS124	13	7	5.4
SCDS125	13	7	5.4
SCDS127	13	7	5.4

Standard Specifications

Stamp	Inductance (μH)	RDC (mΩ) Max									
		SCDS 62T	SCDS 64T	SCDS 73	SCDS 74	SCDS 103R	SCDS 104R	SCDS 105R	SCDS 124	SCDS 125	SCDS 127
R80	0.8							4.3			
1R2	1.2										7.0
1R5	1.5						8.1	5.8			
2R2	2.2							11			
2R4	2.4										11.5
2R5	2.5						10.5				
3R3	3.3	68						10.4			
3R5	3.5										13.5
3R8	3.8						13				
3R9	3.9								15		
4R7	4.7	80				30		12.3	18		15.8
5R2	5.2						22				
5R5	5.5	96									
6R1	6.1										17.6
6R8	6.8	100				35		18	23		
7R0	7.0						27				
7R6	7.6										20.0
8R2	8.2	100						20			
100	10	150	120	72	49	59	35	26	28	25	21.6
120	12	200	130	98	58			33	38	27	24.3
150	15	230	180	130	81	91	50	41	50	30	27.0
180	18	270	240	140	91			46	57	34	39.2
220	22	340	270	190	110		73	61	66	36	43.2
270	27	380	300	210	150			69	80	51	45.9
330	33	450	330	240	170	202	93	84	97	57	64.8
390	39	490	370	320	230			106	132	68	72.9
470	47	690	520	360	260		128	130	150	75	100
560	56	780	560	470	350			149	190	110	110
680	68	1070	630	520	380		213	201	220	120	140
820	82	1210	710	690	430			227	260	140	160
101	100	1390	1030	790	610			304	253	308	160
121	120	1900	1150	890	660				303	380	170
151	150	2180	1680	1270	880		506	370	530	230	280
181	180	2770	1870	1450	980			419	620	290	350
221	220	3120	2080	1650	1170			756	500	700	400
271	270	4380	2370	2310	1640				672	876	460
331	330	4940	2670	2620	1860		1.09	812	990	510	640
391	390		2940	2940	2850			953		690	700
471	470		3930	4180	3010			1289		770	980
561	560		5430	4670	3620			1430		860	1070
681	680		7320	5730	4630			1599		1200	1460
821	820		8240	6540	5200			1768		1340	1640
102	1000		9260	9440	6000			1989		1530	1820

Test Freq. (L): 103R/ 104R/ 105R/ 124 (100KHz/ 1V) , SCDS 127: 1.2~7.6μH (100KHz/ 1V) 10~1000μH (1KHz /1V)
 SCDS 62T: 3.3~8.2μH (7.96MHz/ 1V), 10~82μH (2.52MHz/ 1V), 100~330μH(1KHz/ 1V)
 SCDS 64T/ 73/ 74/ 125: (1KHz/ 1V)

Isat: Inductance drop = 35% typ.

Test Instrument: L: Agilent/ E4980 or HP4284A (over 1MHz), HP4285A (under 1MHz)

RDC: CH502BC

Rated Current: HP4284+42841A or WK3260B+WK3265B

Standard Specifications

Stamp	Inductance (μH)	Isat (A)									
		SCDS 62	SCDS 64	SCDS 73	SCDS 74	SCDS 103R	SCDS 104R	SCDS 105R	SCDS 124	SCDS 125	SCDS 127
R80	0.8							13.5			
1R2	1.2										9.80
1R5	1.5						10.0	10.5			
2R2	2.2							9.25			
2R4	2.4										8.00
2R5	2.5						7.5				
3R3	3.3	1.94						7.8			
3R5	3.5										7.50
3R8	3.8						6.0				
3R9	3.9								6.50		
4R7	4.7	1.63				4.65		6.40	5.70		6.80
5R2	5.2						5.5				
5R5	5.5	1.40									
6R1	6.1										6.60
6R8	6.8	1.33				3.84		5.40	4.90		
7R0	7.0						4.8				
7R6	7.6										5.90
8R2	8.2	1.14						4.85			
100	10	1.10	1.35	1.68	1.84	3.18	4.4	4.45	4.50	4.00	5.40
120	12	1.00	1.22	1.52	1.71			4.00	4.00	3.50	4.90
150	15	0.90	1.11	1.33	1.47	2.60	3.6	3.60	3.20	3.30	4.50
180	18	0.80	1.02	1.20	1.31			3.20	3.10	3.00	3.90
220	22	0.74	0.91	1.07	1.23		2.9	2.95	2.90	2.80	3.60
270	27	0.66	0.82	0.96	1.12			2.70	2.80	2.30	3.40
330	33	0.59	0.74	0.91	0.96	1.74	2.3	2.50	2.70	2.10	3.00
390	39	0.54	0.69	0.77	0.91			2.30	2.10	2.00	2.75
470	47	0.50	0.62	0.76	0.88		2.1	2.00	1.90	1.80	2.50
560	56	0.46	0.58	0.68	0.75			1.90	1.80	1.70	2.35
680	68	0.42	0.51	0.61	0.69		1.5	1.65	1.50	1.50	2.10
820	82	0.38	0.46	0.57	0.61			1.50	1.30	1.40	1.95
101	100	0.34	0.42	0.50	0.60		1.35	1.35	1.20	1.30	1.70
121	120	0.31	0.38	0.49	0.52			1.28	1.10	1.10	1.60
151	150	0.28	0.35	0.43	0.46		1.15	1.12	0.95	1.00	1.42
181	180	0.26	0.32	0.39	0.42			1.04	0.85	0.90	1.30
221	220	0.23	0.29	0.35	0.36		0.92	0.94	0.80	0.80	1.16
271	270	0.22	0.26	0.32	0.34			0.84	0.60	0.75	1.06
331	330	0.19	0.23	0.28	0.32		0.70	0.75	0.50	0.68	0.95
391	390		0.22	0.26	0.29			0.70		0.65	0.88
471	470		0.20	0.24	0.26			0.60		0.58	0.79
561	560		0.18	0.22	0.23			0.54		0.54	0.73
681	680		0.17	0.19	0.22			0.52		0.48	0.67
821	820		0.15	0.18	0.20			0.50		0.43	0.60
102	1000		0.14	0.16	0.18			0.48		0.40	0.55

Tolerance Of Inductors

- SCDS 62T 3.3 ~ 330uH ± 20%
- SCDS 64T 10 ~ 1000uH ± 20%
- SCDS 73 10 ~ 1000uH ± 20%
- SCDS 74 10 ~ 1000uH ± 20%
- SCDS 103R 4.7~33uH ± 30%
- Tolerance : M = ±20%, T = ±30%, N = ⁺⁴⁰/₋₂₀%
- SCDS 104R 1.5 ~ 330uH ± 30%
- SCDS 105R 0.8 ~ 1000uH ± 30%
- SCDS 124 3.9 ~ 330uH ±20%
- SCDS 125 10 ~ 1000uH ± 20%
- SCDS 127 1.2 ~ 7.6uH ⁺⁴⁰/₋₂₀%
- SCDS 127 10 ~ 1000uH ± 20%

Curves of SCDS Series

Test Instruments : HP4294 Impedance / Material Analyzer

SCDS62

INDUCTANCE vs. FREQUENCY CHARACTERISTICS

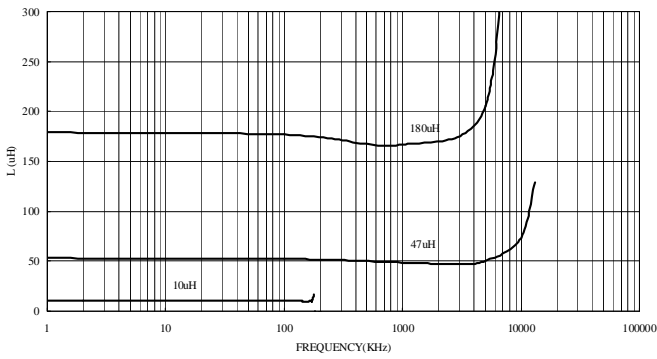

Inductance vs. DC Current

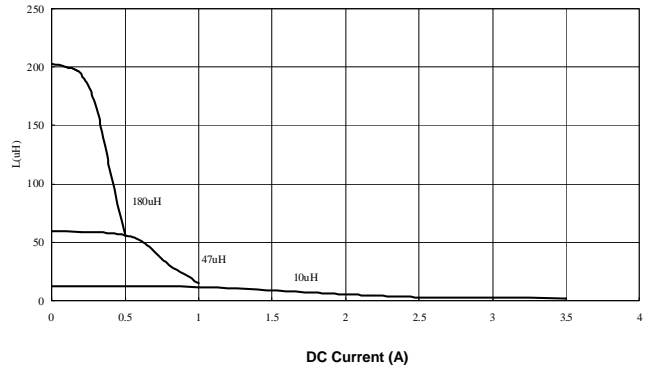

SCDS64

INDUCTANCE vs. FREQUENCY CHARACTERISTICS

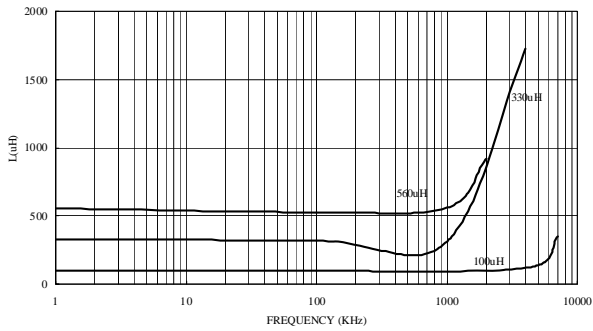

Inductance vs. DC Current

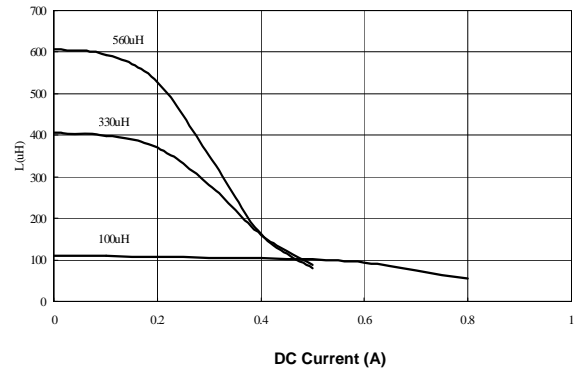

SCDS73

INDUCTANCE vs. FREQUENCY CHARACTERISTICS

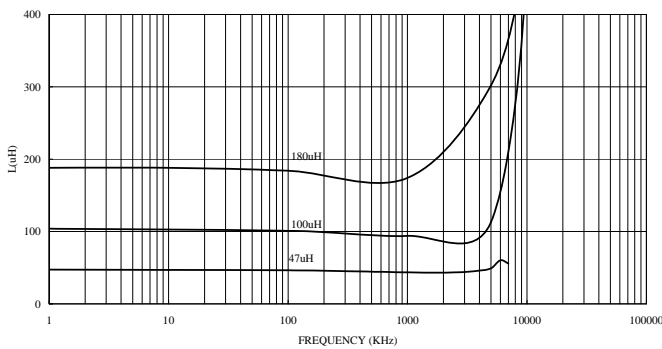

Inductance vs. DC Current

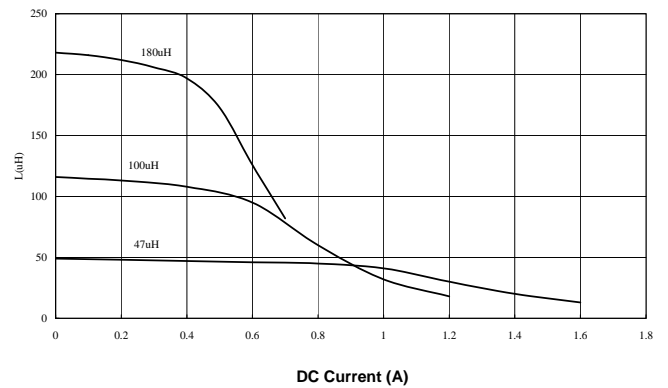

Test Instruments : HP4294 Impedance / Material Analyzer

SCDS74

INDUCTANCE vs. FREQUENCY CHARACTERISTICS

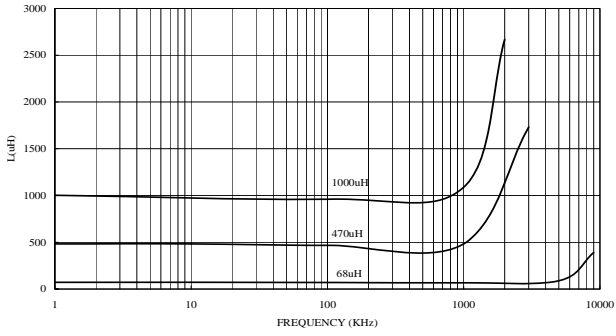

Inductance vs. DC Current

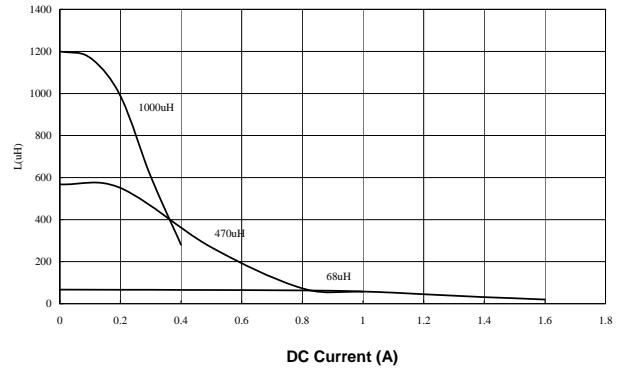

SCDS104R

SCDS104R-220M-N

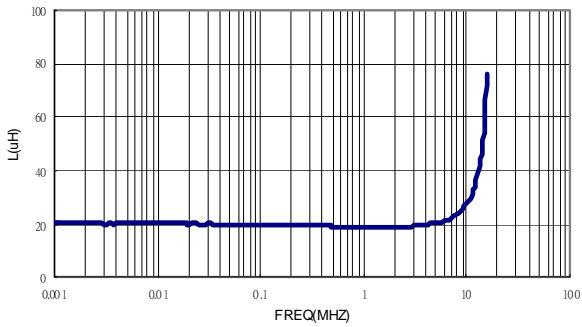

SCDS104R-220M-N

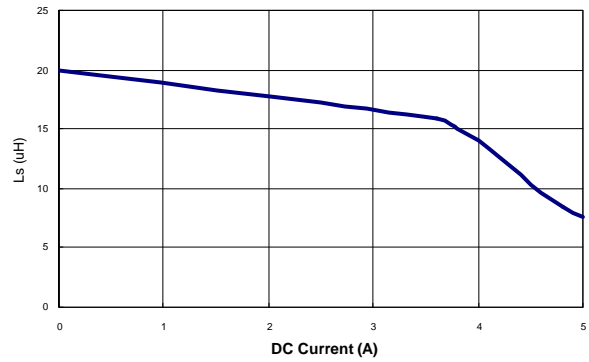

SCDS124

INDUCTANCE vs. FREQUENCY CHARACTERISTICS

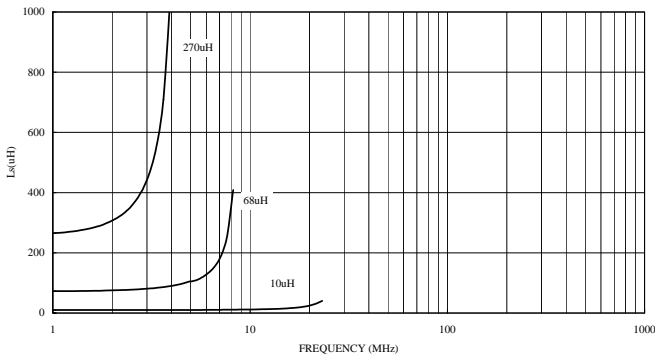

Inductance vs. DC Current

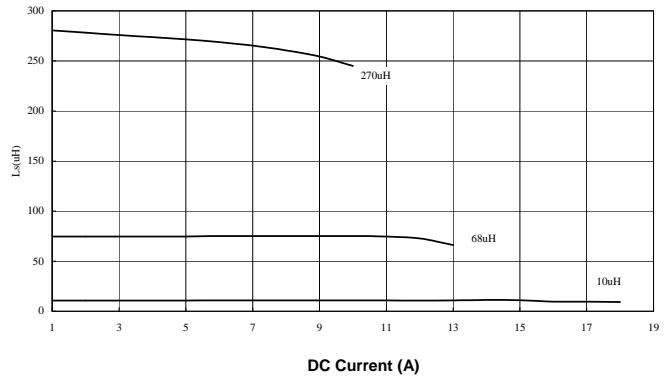

Test Instruments : HP4294 Impedance / Material Analyzer

SCDS125

INDUCTANCE vs. FREQUENCY CHARACTERISTICS

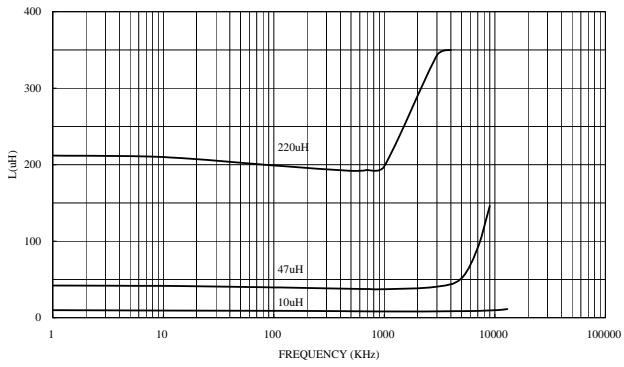

Inductance vs. DC Current

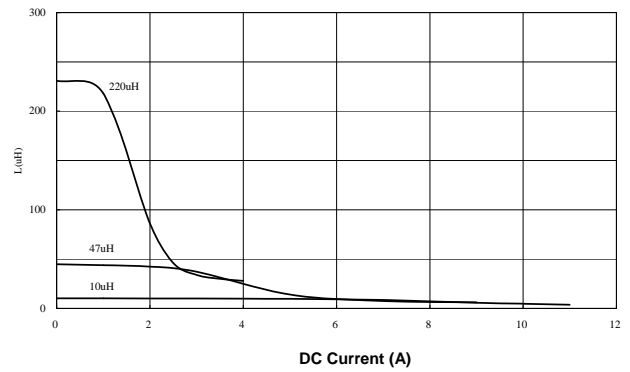

SCDS127

INDUCTANCE vs. FREQUENCY CHARACTERISTICS

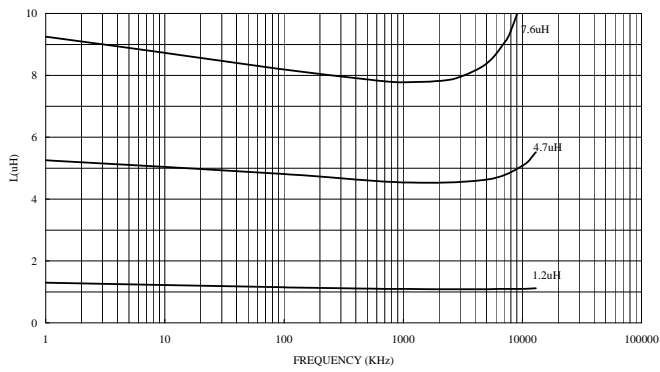

Inductance vs. DC Current

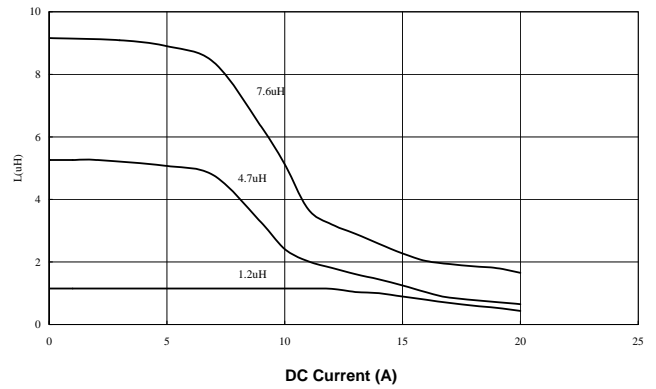

Packaging Specifications

Tape Dimensions

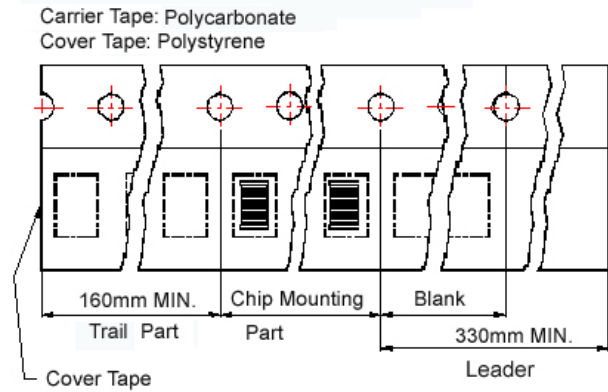
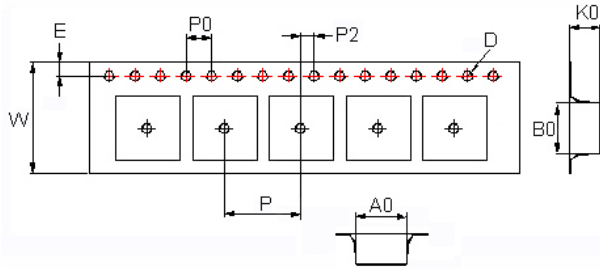

Reel Dimensions

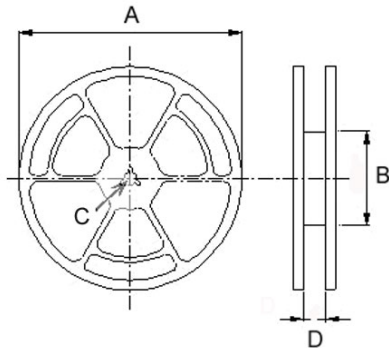

Dimensions in mm

TYPE	Tape Dimensions									Reel Dimensions				Quantity
	A0	B0	K0	D	E	W	P	P0	P2	A	B	C	D	PCS / REEL
SCDS 62	6.5	6.2	3.4	1.55	1.75	16	12	4	2	330	100	13	17.4	1500
SCDS 64	6.5	6.2	4.95	1.55	1.75	16	12	4	2	330	100	13	17.4	1000
SCDS 73	7.6	7.6	3.6	1.55	1.75	16	12	4	2	330	100	13	17.4	1600
SCDS 74	7.6	7.6	5.0	1.55	1.75	16	12	4	2	330	100	13	17.4	1000
SCDS 103R	10.6	10.75	4.2	1.55	1.75	24	16	4	2	300	100	13	24.4	1000
SCDS 104R	10.6	10.75	4.2	1.5	1.75	24	16	4	2	330	100	13	24.4	1000
SCDS 105R	10.6	10.6	5.0	1.5	1.75	24	16	4	2	330	100	13	24.4	500
SCDS 124	13.0	12.8	5.1	1.55	1.75	24	16	4	2	330	100	13	24.4	500
SCDS 125	12.6	12.6	6.7	1.55	1.75	24	16	4	2	330	100	13	24.4	600
SCDS 127	12.6	12.6	8.7	1.55	1.75	24	16	4	2	330	100	13	24.4	500