

SCK-SERIES Part Number Code

[A]

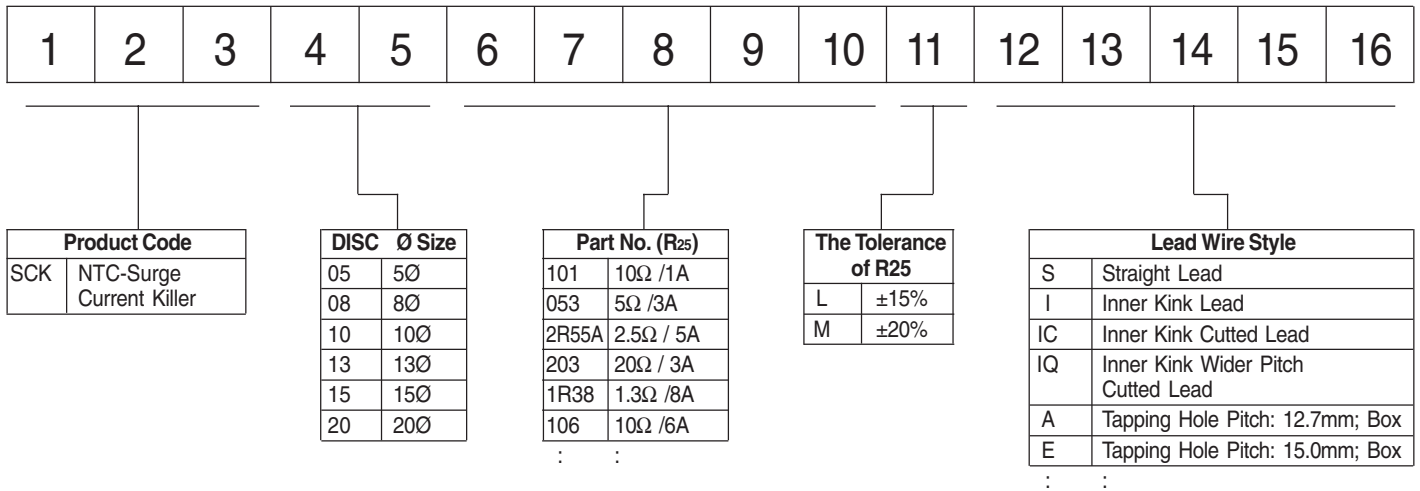

[B]

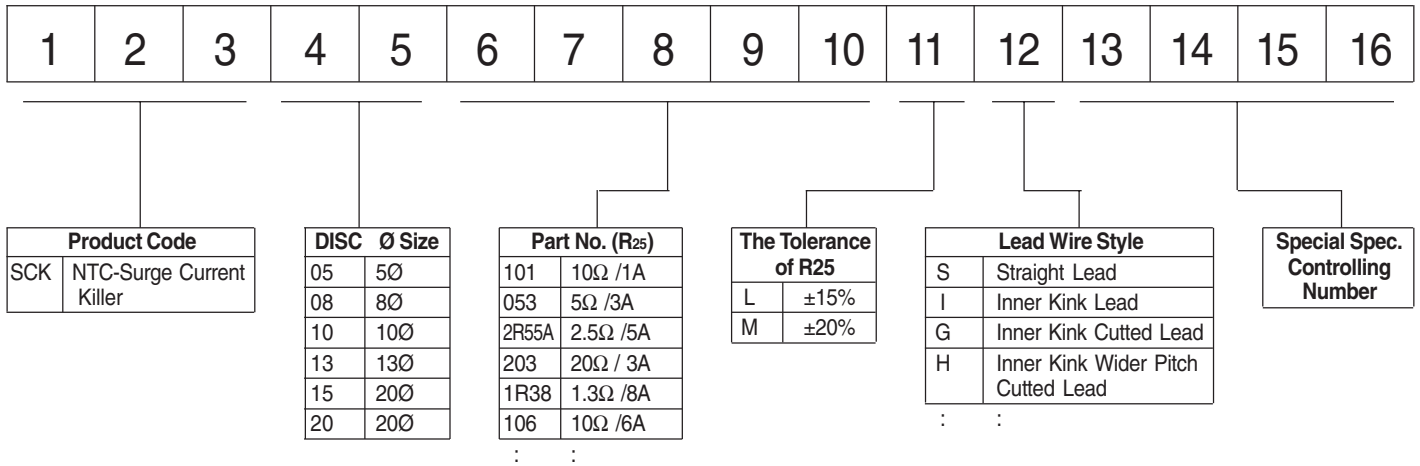

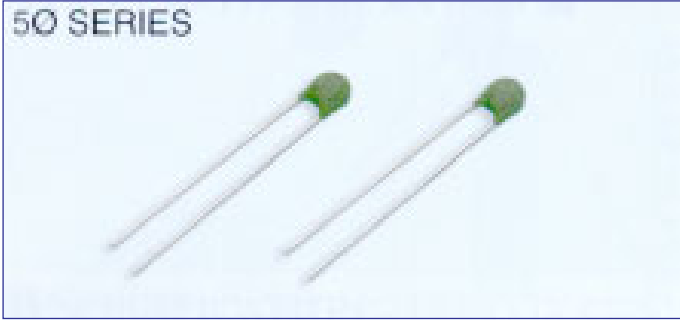

POWER DERATING CURVE

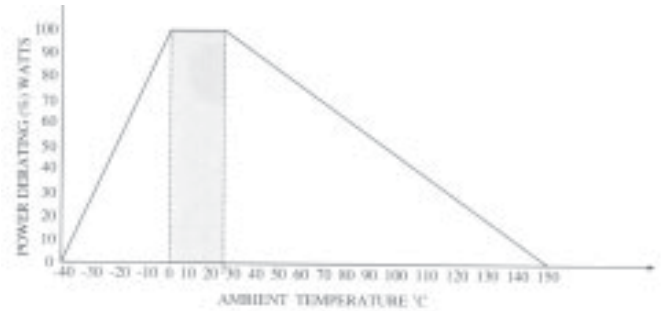

SPECIFICATION

Part No	Zero Power Resistance at 25°C (Ω)	Max. Steady State Current at 25°C (A)	Approx. Resistance at Max. Current at 25°C (mΩ)	Thermal Dissipation Constant (mW/°C)	Thermal Time Constant (Sec.)	Operating Temperature (°C)
SCK-052	5	2	429	14	17	-40~+150
SCK-101	10	1	1126	15	17	-40~+150
SCK-20X3	20	0.3	5560	14	22	-40~+150

R-T CHARACTERISTIC CURVE

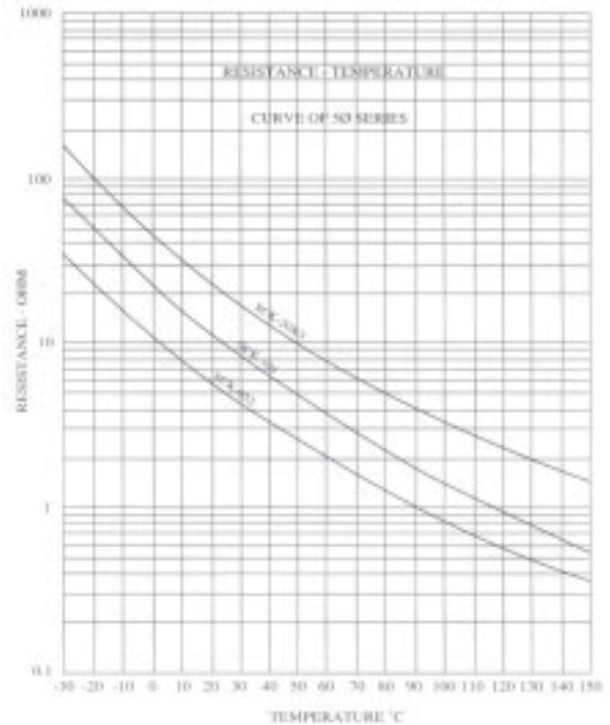

DIMENSION

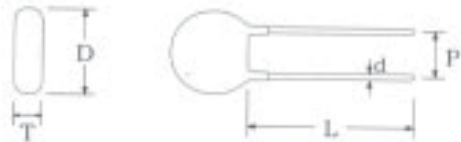

Disc Ø	D max.	L min.	d. nor.	P. nor.	T. max.
5	6.5	31	0.8±0.02	4±0.6	5

Unit. mm

V-I CHARACTERISTIC CURVE

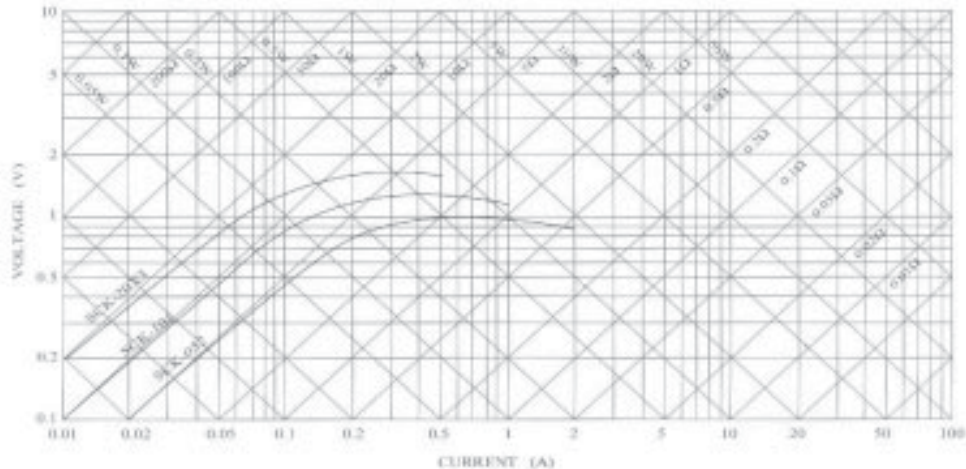

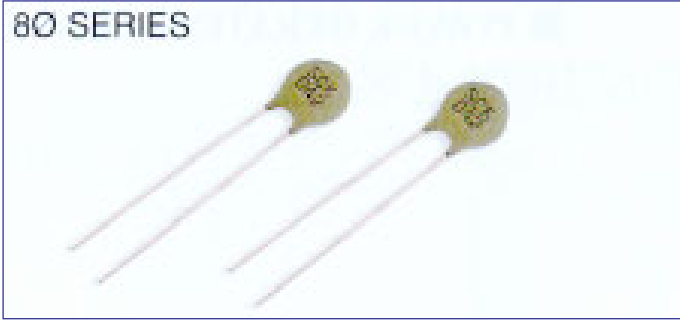

POWER DERATING CURVE

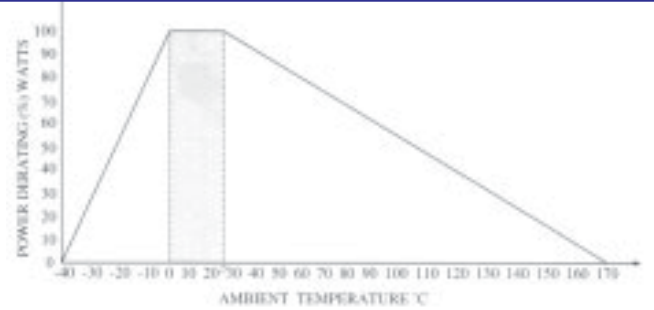

SPECIFICATION

Part No	Zero Power Resistance at 25°C (Ω)	Max. Steady State Current at 25°C (A)	Approx. Resistance at Max. Current at 25°C (mΩ)	Thermal Dissipation Constant (mW/°C)	Thermal Time Constant (Sec.)	Operating Temperature (°C)
SCK-042	4	2	441	17	31	-40~+170
SCK-053	5	3	261	17	36	-40~+170
SCK-063	6	3	283	17	38	-40~+170
SCK-082	8	2	520	16	36	-40~+170
SCK-102	10	2	542	17	38	-40~+170
SCK-152	15	2	548	15	38	-40~+170
SCK-201	20	1	1544	17	41	-40~+170

R-T CHARACTERISTIC CURVE

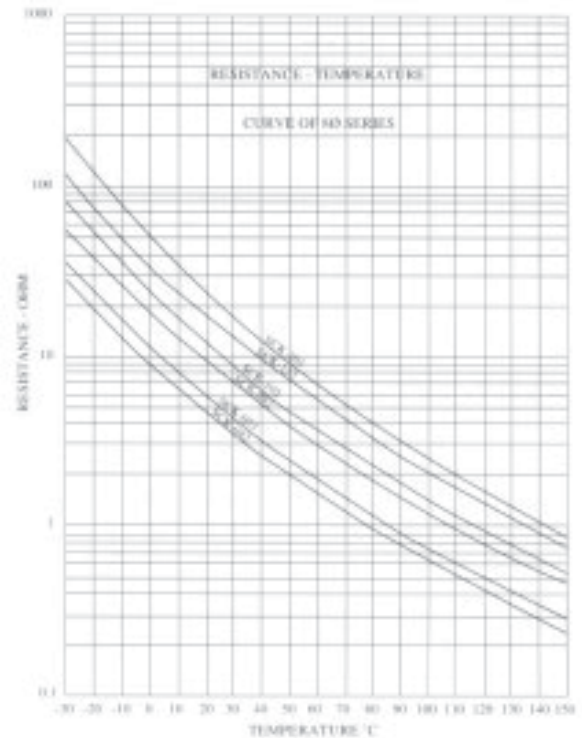

DIMENSION

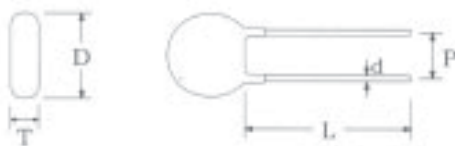

Unit. mm

Disc Ø	D max.	L. min.	d. nor.	P. nor.	T. max.
8	9.5	31	0.8±0.02	5±0.8	5

V-I CHARACTERISTIC CURVE

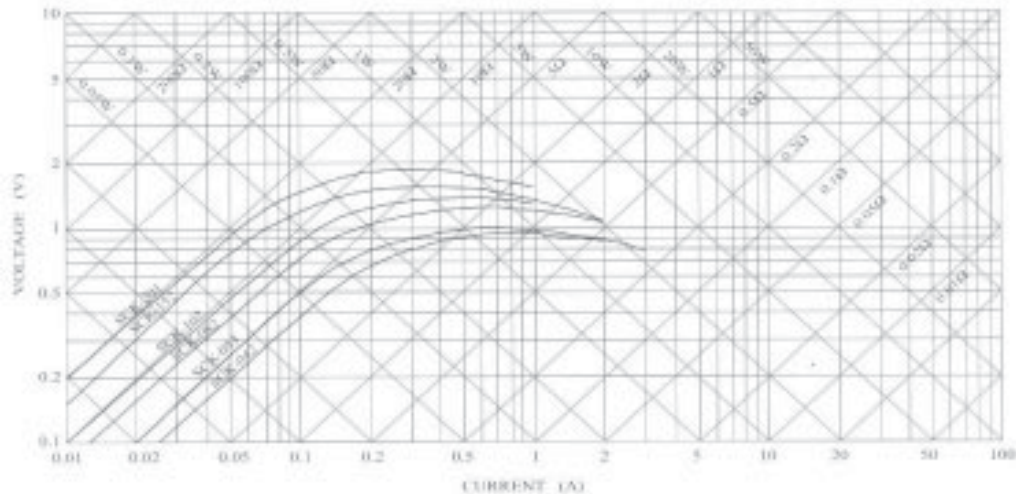



SPECIFICATION

Part No	Zero Power Resistance at 25°C (Ω)	Max. Steady State Current at 25°C (A)	Approx. Resistance at Max. Current at 25°C (mΩ)	Thermal Dissipation Constant (mW/°C)	Thermal Time Constant (Sec.)	Operating Temperature (°C)
SCK-015	1	5	91	17	33	-40~+170
SCK-1R55	1.5	5	101	17	34	-40~+170
SCK-2R55A	2.5	5	120	18	46	-40~+170
SCK-034	3	4	156	18	45	-40~+170
SCK-035	3	5	119	18	45	-40~+170
SCK-044	4	4	161	16	40	-40~+170
SCK-054	5	4	180	17	33	-40~+170
SCK-083	8	3	278	17	43	-40~+170
SCK-103	10	3	297	17	46	-40~+170
SCK-122	12	2	512	18	50	-40~+170
SCK-123	12	3	301	18	50	-40~+170
SCK-133	13	3	356	18	49	-40~+170
SCK-152X	15	2.5	442	17	51	-40~+170
SCK-162	16	2	604	18	55	-40~+170
SCK-162X	16	2.5	442	16	45	-40~+170
SCK-202	20	2	646	17	54	-40~+170
SCK-252	25	2	674	17	52	-40~+170
SCK-302	30	2	700	17	50	-40~+170
SCK-472	47	2	720	18	49	-40~+170
SCK-501X	50	1.5	1170	18	48	-40~+170
SCK-502	50	2	813	18	48	-40~+170
SCK-801	80	1	2236	17	53	-40~+170
SCK-1201	120	1	2406	19	54	-40~+170

DIMENSION

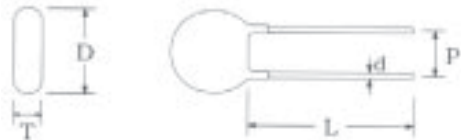

Disc Ø	D max.	L min.	d. nor.	P. nor.	T. max.
10	11.5	31	0.8±0.02	5±0.8	5

V-I CHARACTERISTIC CURVE

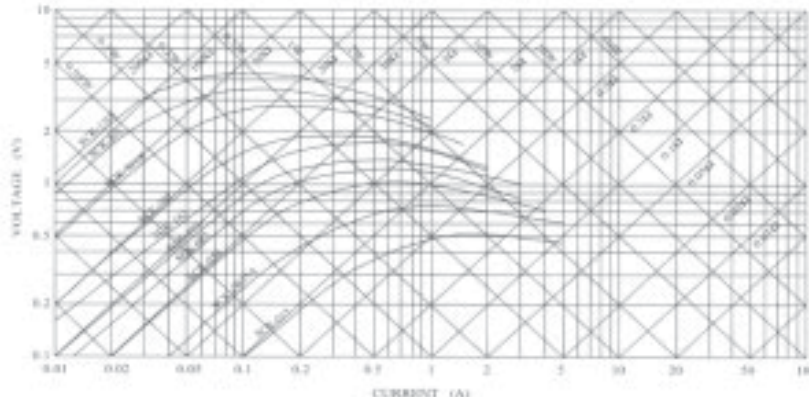

POWER DERATING CURVE

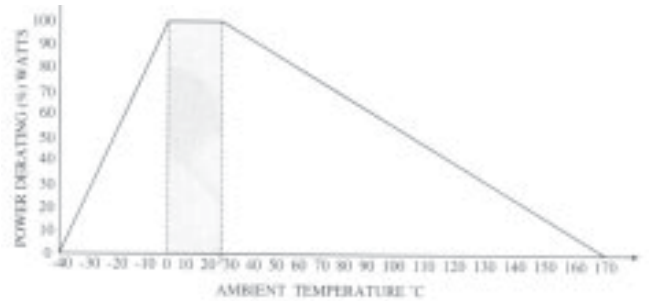

R-T CHARACTERISTIC CURVE

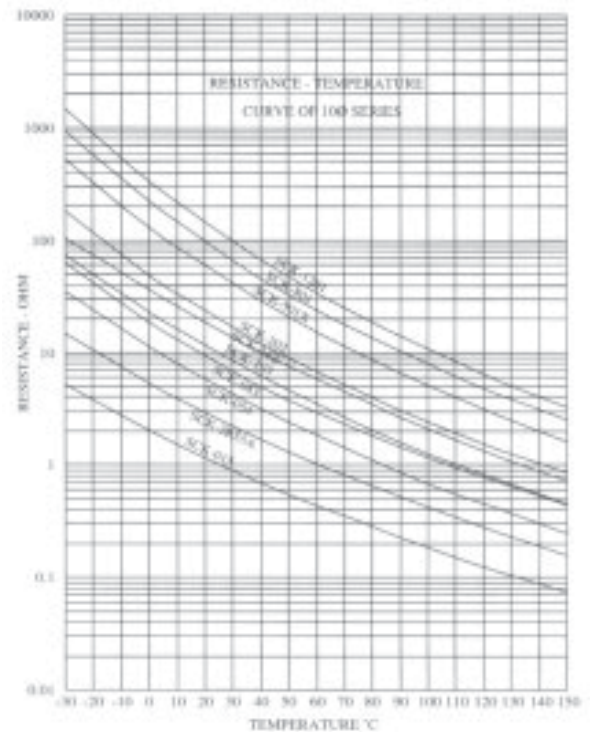

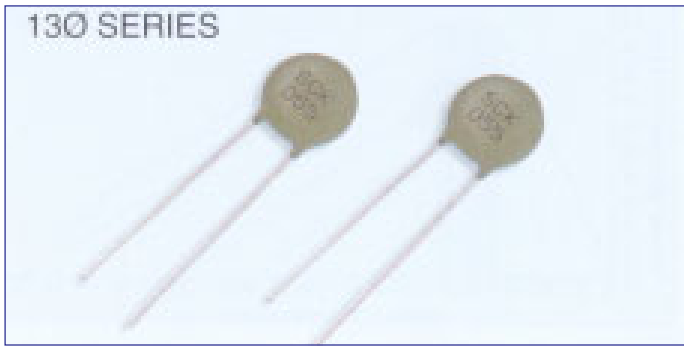

POWER DERATING CURVE

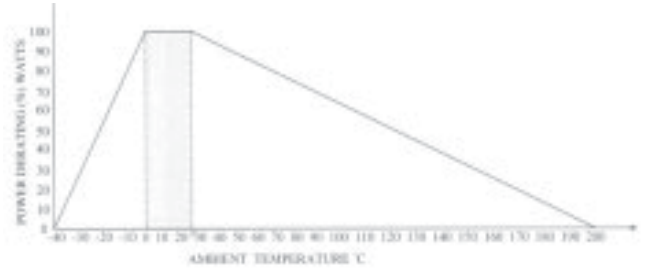

SPECIFICATION

Part No	Zero Power Resistance at 25°C (Ω)	Max. Steady State Current at 25°C (A)	Approx. Resistance at Max. Current at 25°C (mΩ)	Thermal Dissipation Constant (mW/°C)	Thermal Time Constant (Sec.)	Operating Temperature (°C)
SCK-1R37	1.3	7	70	17	49	-40~+200
SCK-2R55	2.5	5	117	17	61	-40~+200
SCK-2R56	2.5	6	94	17	48	-40~+200
SCK-055	5	5	166	18	75	-40~+200
SCK-084	8	4	206	17	65	-40~+200
SCK-104	10	4	217	17	66	-40~+200
SCK-124	12	4	217	17	66	-40~+200
SCK-153	15	3	343	18	66	-40~+200
SCK-203	20	3	410	20	76	-40~+200

R-T CHARACTERISTIC CURVE

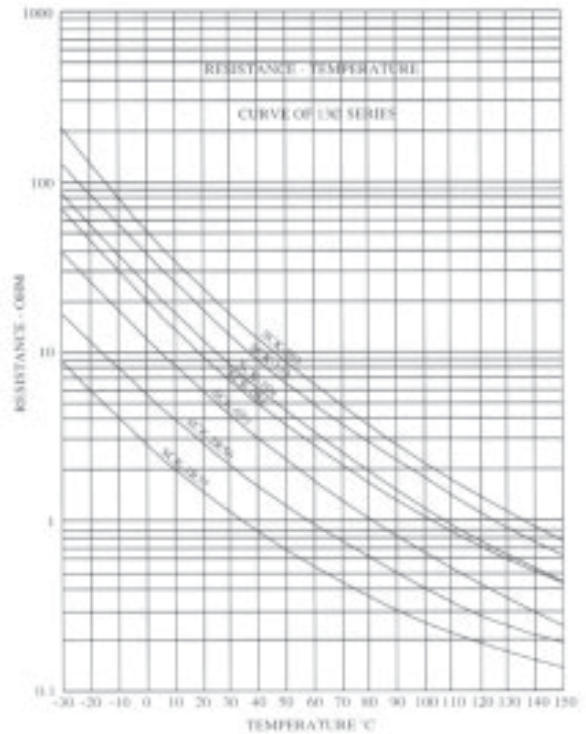

DIMENSION

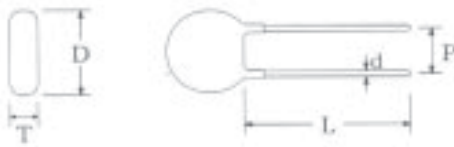

Unit. mm

Disc Ø	D max.	L. min.	d. nor.	P. nor.	T. max.
13	14.5	30	0.8±0.02	7.5±1.1	6

V-I CHARACTERISTIC CURVE

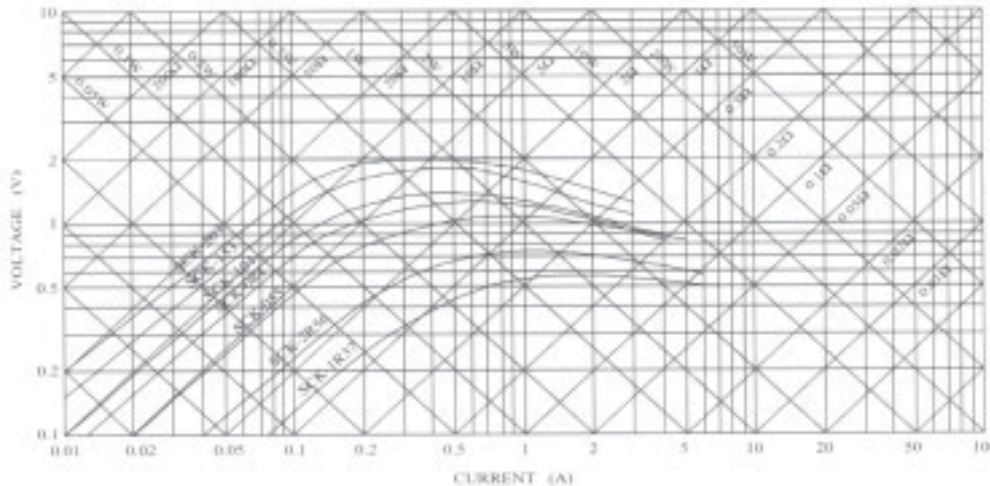

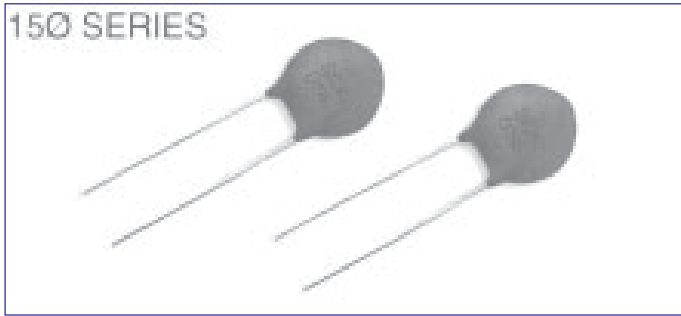

SPECIFICATION

Part No	Zero Power Resistance at 25°C (Ω)	Max. Steady State Current at 25°C (A)	Approx. Resistance at Max. Current at 25°C (mΩ)	Thermal Dissipation Constant (mW/°C)	Thermal Time Constant (Sec.)	Operating Temperature (°C)
SCK-1R38	1.3	8	64	21	59	-40~+200
SCK-1R58	1.5	8	62	21	66	-40~+200
SCK-2R58	2.5	8	75	20	63	-40~+200
SCK-037	3	7	91	21	73	-40~+200
SCK-046	4	6	117	20	62	-40~+200
SCK-048	4	8	87	27	76	-40~+200
SCK-056	5	6	121	20	66	-40~+200
SCK-057	5	7	98	20	65	-40~+200
SCK-065	6	5	159	20	74	-40~+200
SCK-075	7	5	161	20	79	-40~+200
SCK-078	7	8	108	28	57	-40~+200
SCK-086	8	6	130	20	68	-40~+200
SCK-105	10	5	178	20	79	-40~+200
SCK-125	12	5	185	19	59	-40~+200
SCK-152	15	2	704	21	77	-40~+200
SCK-154	15	4	261	19	79	-40~+200
SCK-164	16	4	261	19	79	-40~+200
SCK-204	20	4	283	18	90	-40~+200
SCK-224	22	4	308	20	80	-40~+200
SCK-253	25	3	425	21	76	-40~+200
SCK-403	40	3	511	22	83	-40~+200
SCK-404	40	4	360	22	86	-40~+200
SCK-473	47	3	501	20	77	-40~+200
SCK-802X	80	2.5	693	19	71	-40~+200
SCK-1202	120	2	1010	19	65	-40~+200

DIMENSION

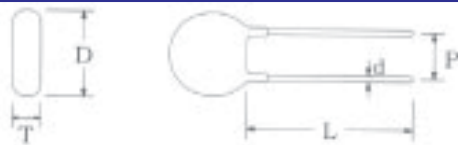

Disc Ø	D max.	L min.	d. nor.	P. nor.	T. max.
15	16.5	29	1.0±0.02	8±1.2	6

V-I CHARACTERISTIC CURVE

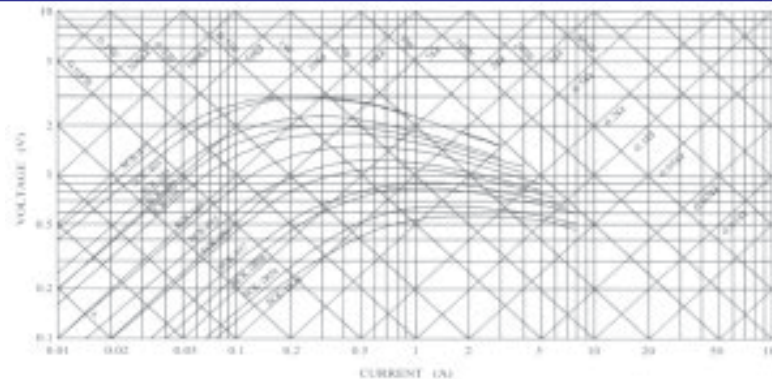

POWER DERATING CURVE

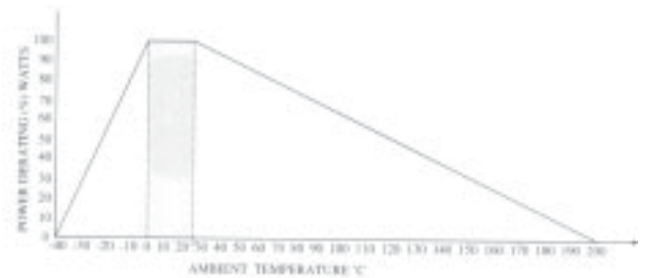

R-T CHARACTERISTIC CURVE

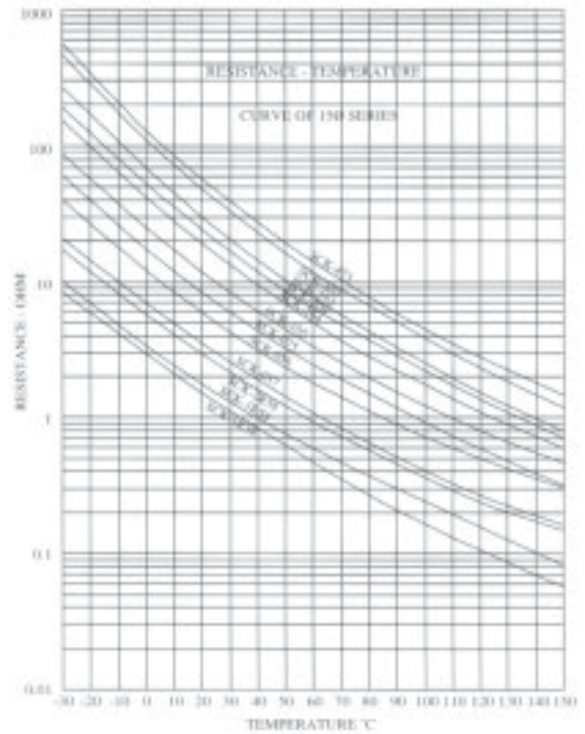

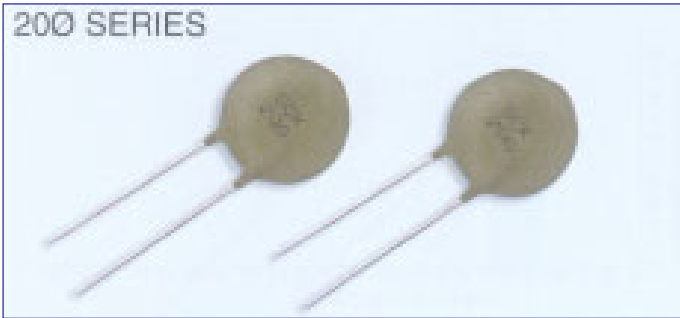

SPECIFICATION

Part No	Zero Power Resistance at 25°C (Ω)	Max. Steady State Current at 25°C (A)	Approx. Resistance at Max. Current at 25°C (mΩ)	Thermal Dissipation Constant (mW/°C)	Thermal Time Constant (Sec.)	Operating Temperature (°C)
SCK-0R78	0.7	8	59	28	96	-40~+200
SCK-0R715	0.7	15	35	29	122	-40~+200
SCK-0120	1	20	20	25	73	-40~+200
SCK-0212	2	12	49	29	101	-40~+200
SCK-2R512	2.5	12	60	29	104	-40~+200
SCK-2R515	2.5	15	46	29	103	-40~+200
SCK-0310	3	10	63	28	100	-40~+200
SCK-058	5	8	93	28	101	-40~+200
SCK-0510	5	10	82	29	123	-40~+200
SCK-0512	5	12	66	29	124	-40~+200
SCK-106	10	6	173	32	100	-40~+200
SCK-108	10	8	122	29	119	-40~+200
SCK-128	12	8	106	24	130	-40~+200
SCK-138	13	8	106	24	130	-40~+200
SCK-206	20	6	190	28	107	-40~+200

DIMENSION

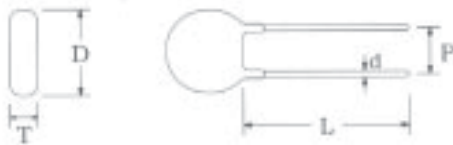

Unit. mm

Disc Ø	D max.	L. min.	d. nor.	P. nor.	T. max.
20	21.5	26	1.0±0.02	8±1.2	6

V-I CHARACTERISTIC CURVE

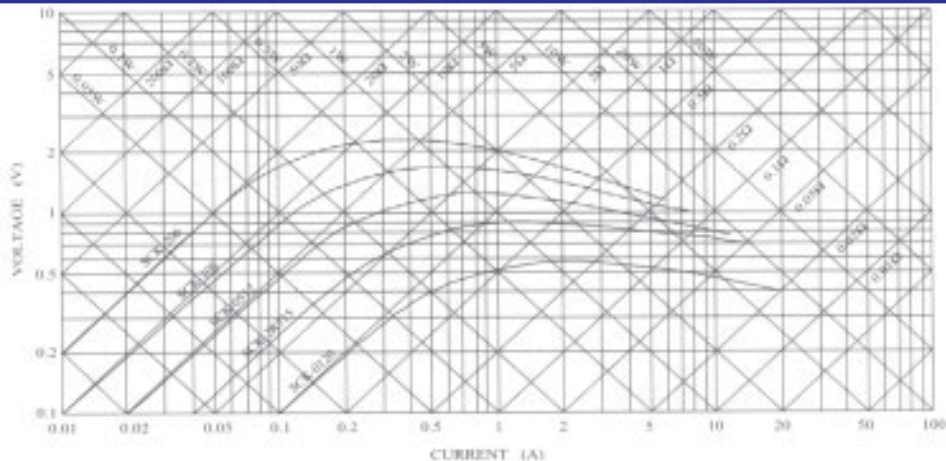

POWER DERATING CURVE

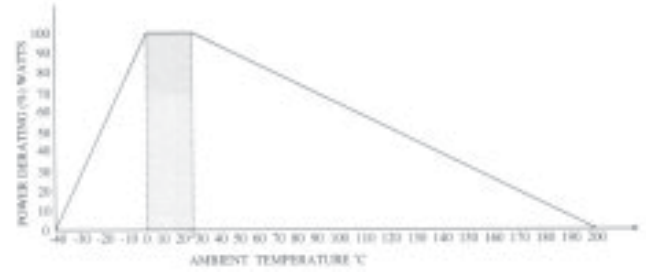

R-T CHARACTERISTIC CURVE

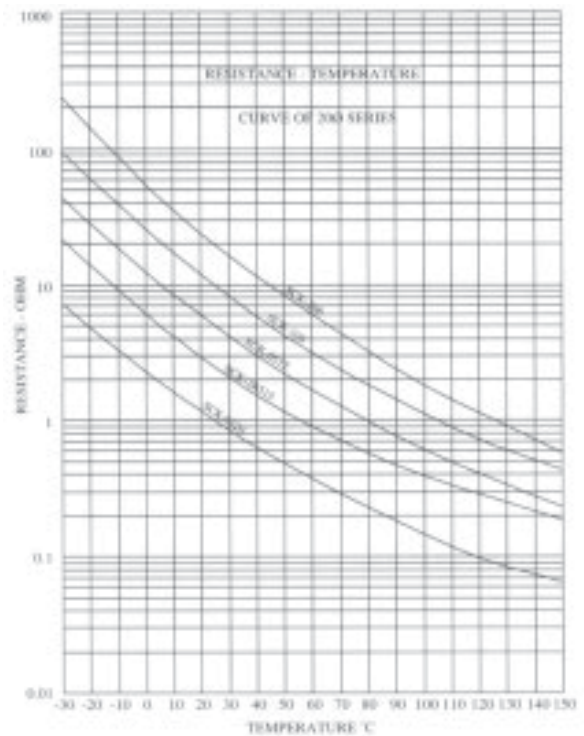

TTC-SERIES Part Number Code

[A]

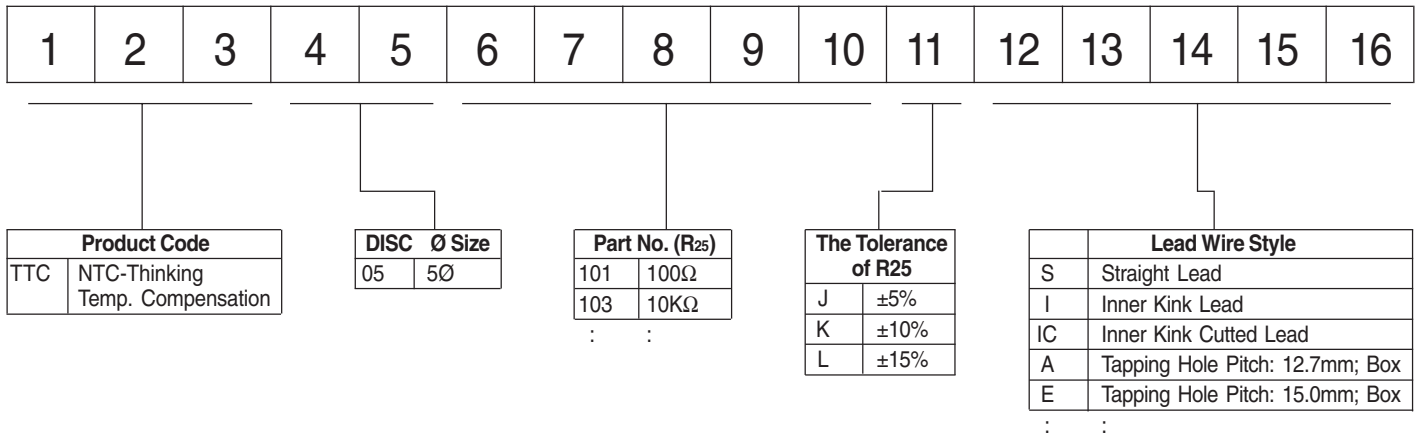

[B]

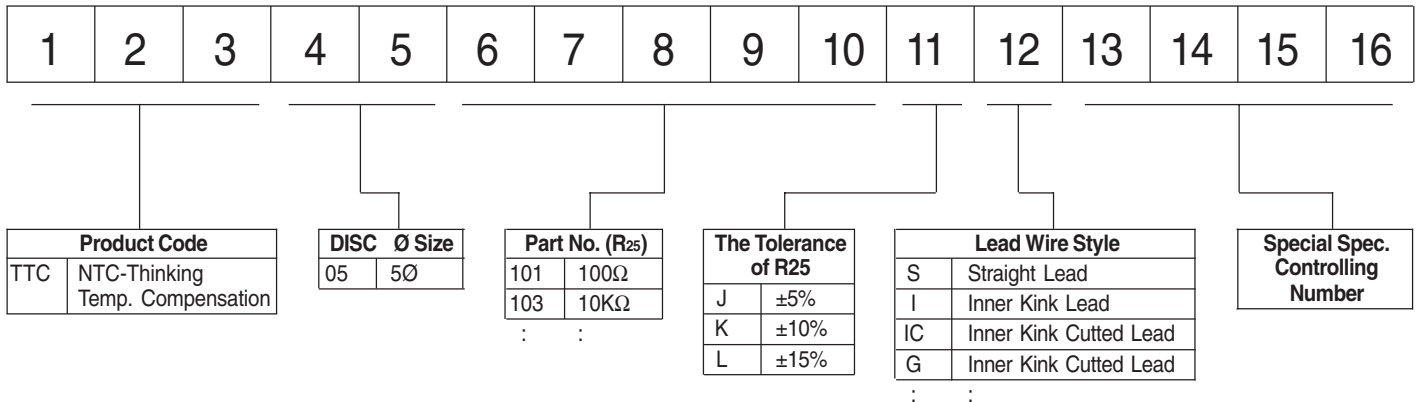



DIMENSION



Unit. mm

Disc Ø	D max.	L. min.	d. nor.	P. nor.	T. max.
5	6.5	31	0.5±0.02	3.5±0.5	5



Unit. mm

Disc Ø	D max.	L. min.	d. nor.	P. nor.	T. max.
5	6.5	31	0.5±0.02	5.0±0.8	5

SPECIFICATION

Part No	Zero Power Resistance at 25°C (Ω)	B-Value R25/R50 (K)	Max. Permissible Current at 25°C (mA)	Thermal Dissipation Constant (mW/°C)	Thermal Time Constant (Sec.)	Operating Temperature (°C)
TTC-005	5	2400	610	9	16	-30~+125
TTC-010	10	2800	500	9	22	-30~+125
TTC-015	15	2800	390	8	19	-30~+125
TTC-020	20	2800	350	9	25	-30~+125
TTC-025	25	2900	300	8	19	-30~+125
TTC-045	45	3100	270	9	23	-30~+125
TTC-050	50	3100	250	9	19	-30~+125
TTC-060	60	3100	220	9	21	-30~+125
TTC-085	85	3200	180	9	22	-30~+125
TTC-090	90	3200	180	9	18	-30~+125
TTC-101	100	3200	170	9	19	-30~+125
TTC-121	120	3300	145	8	20	-30~+125
TTC-151	150	3300	140	9	19	-30~+125
TTC-201	200	3500	130	9	17	-30~+125
TTC-221	220	3500	125	9	20	-30~+125
TTC-251	250	3500	120	9	21	-30~+125
TTC-301	300	3800	115	9	22	-30~+125
TTC-471	470	3500	95	9	28	-30~+125
TTC-501	500	3700	95	9	22	-30~+125
TTC-681	680	3800	75	8	18	-30~+125
TTC-701	700	3800	75	9	17	-30~+125

R-T CHARACTERISTIC CURVE

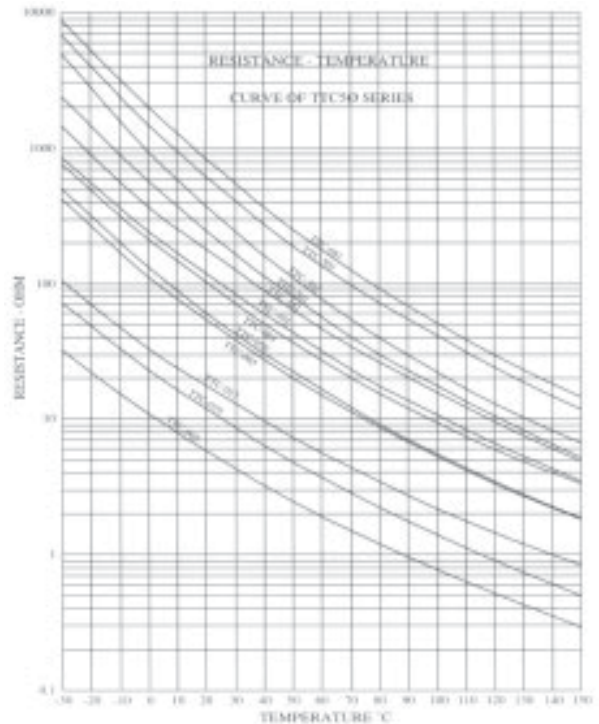

V-I CHARACTERISTIC CURVE

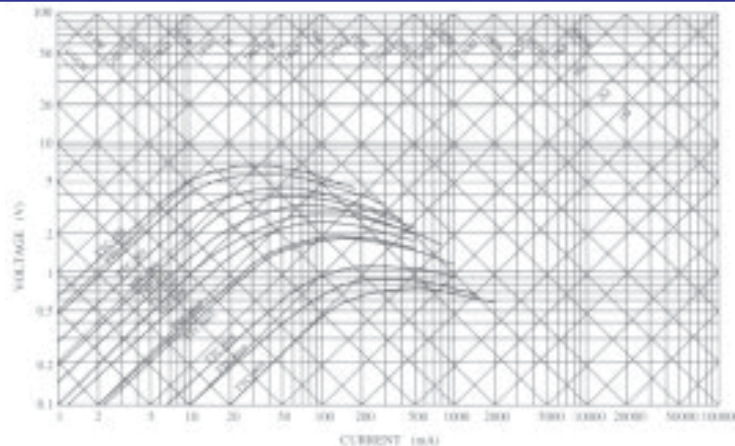

SPECIFICATION

Part No	Zero Power Resistance at 25°C (Ω)	B-Value R25/R50 (K)	Max. Permissible Current at 25°C (mA)	Thermal Dissipation Constant (mW/°C)	Thermal Time Constant (Sec.)	Operating Temperature (°C)
TTC-102	1	3800	70	9	22	-30~+125
TTC-152	1.5	3950	55	8	22	-30~+125
TTC-202	2	4000	50	9	21	-30~+125
TTC-222	2.2	4000	50	9	21	-30~+125
TTC-252	2.5	4000	50	9	21	-30~+125
TTC-302	3	4000	40	9	20	-30~+125
TTC-332	3.3	4000	35	9	19	-30~+125
TTC-402	4	4000	35	8	20	-30~+125
TTC-472	4.7	4050	30	8	21	-30~+125
TTC-502	5	3950	30	9	21	-30~+125
TTC-602	6	4050	30	8	22	-30~+125
TTC-682	6.8	4050	25	9	20	-30~+125
TTC-802	8	4050	25	8	23	-30~+125
TTC-103	10	4050	20	8	21	-30~+125
TTC-123	12	4050	20	8	18	-30~+125
TTC-153	15	4150	20	9	22	-30~+125
TTC-203	20	4250	20	9	23	-30~+125
TTC-303	30	4250	15	8	26	-30~+125
TTC-473	47	4300	10	9	20	-30~+125
TTC-503	50	4300	10	9	17	-30~+125
TTC-104	100	4400	10	8	24	-30~+125
TTC-154	150	4500	5	8	17	-30~+125
TTC-204	200	4600	5	9	15	-30~+125
TTC-224	220	4600	5	9	17	-30~+125

R-T CHARACTERISTIC CURVE

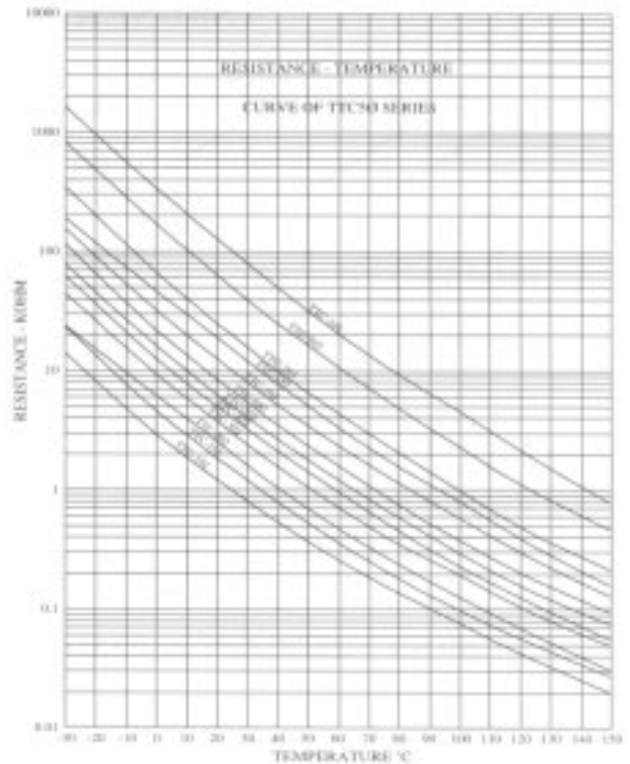

V-I CHARACTERISTIC CURVE

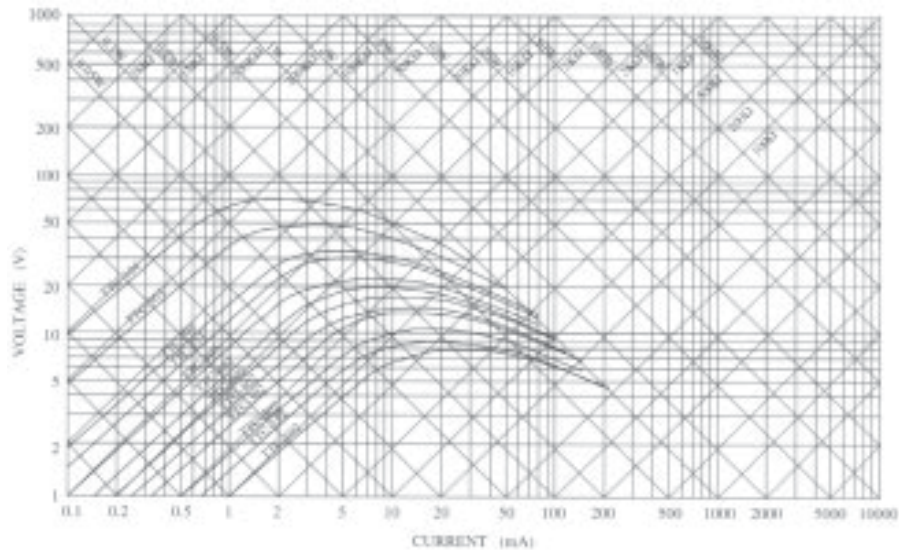

*REMARK: Tolerance of resistance: ±5%, ±10%, ±15%

TSM-SERIES Part Number Code

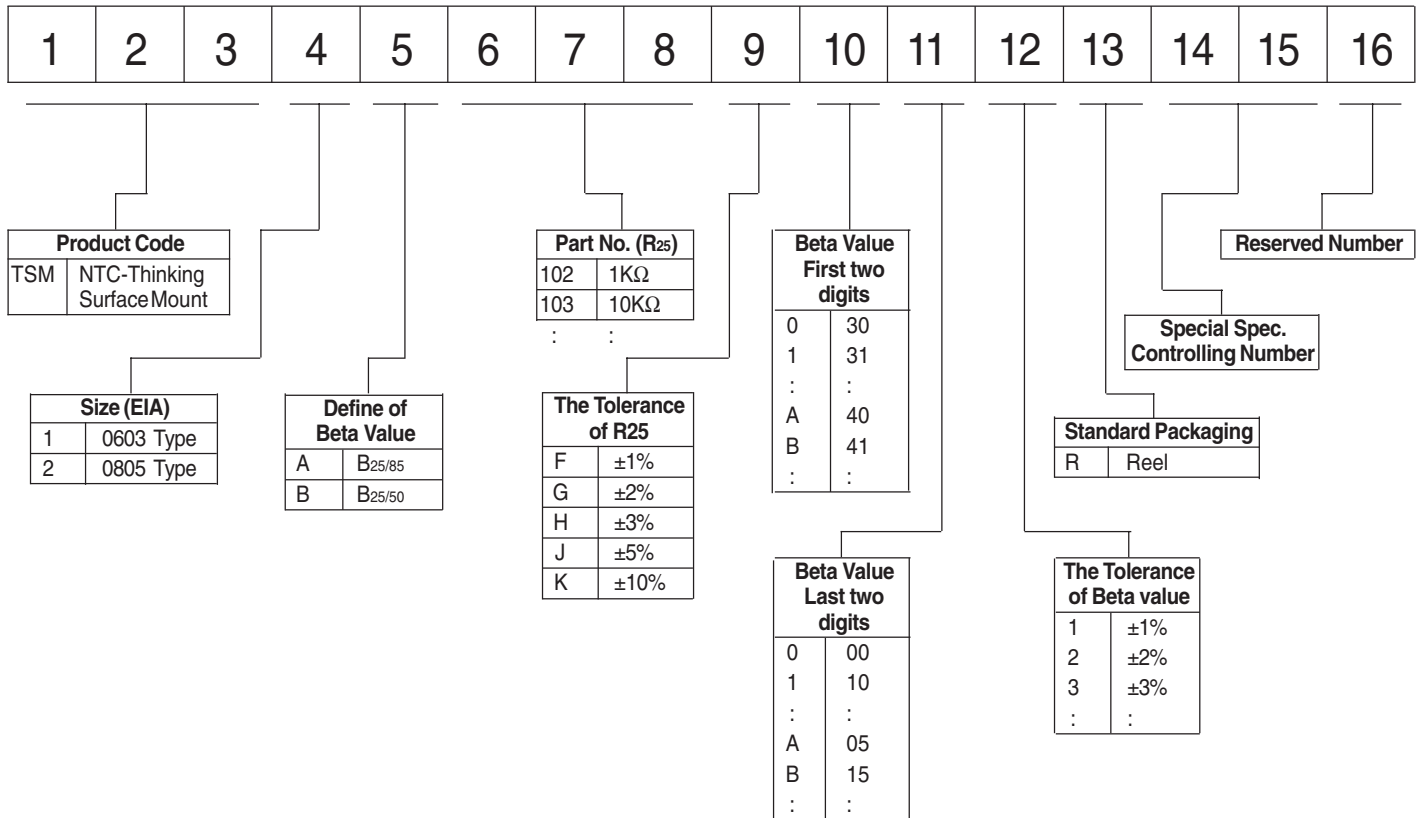

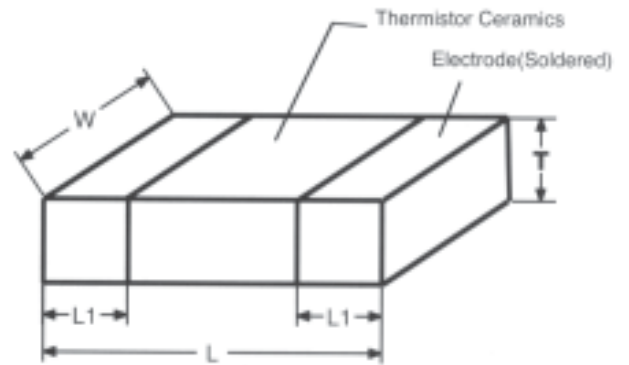

DIMENSION

Unit.: mm

Part. No	Size	L	W	T	L1
TSM1	0603	1.60±0.15	0.80±0.15	0.95max	0.10min
TSM2	0805	2.00±0.20	1.25±0.20	1.20max	0.20min

SPECIFICATION

Part No	Zero Power Resistance at 25°C (KΩ)	Tolerance of Resistance (±%)	B Value (K)	Tolerance of B Value (±%)	
TSM1A-103	10	1 - 2 - 3 - 5 - 10	25/85	3435	1 - 2 - 3
TSM1A-473	47	1 - 2 - 3 - 5 - 10	25/85	3950	1 - 2 - 3
TSM1A-503	50	1 - 2 - 3 - 5 - 10	25/85	3950	1 - 2 - 3
TSM1A-683	68	1 - 2 - 3 - 5 - 10	25/85	4000	1 - 2 - 3
TSM1A-104	100	1 - 2 - 3 - 5 - 10	25/85	4020	1 - 2 - 3
TSM1A-204	200	1 - 2 - 3 - 5 - 10	25/85	3975	1 - 2 - 3
TSM1A-224	220	1 - 2 - 3 - 5 - 10	25/85	3975	1 - 2 - 3
TSM2A-472	4.7	1 - 2 - 3 - 5 - 10	25/85	3435	1 - 2 - 3
TSM2A-502	5.0	1 - 2 - 3 - 5 - 10	25/85	3435	1 - 2 - 3
TSM2A-103	10	1 - 2 - 3 - 5 - 10	25/85	3435	1 - 2 - 3
TSM2A-473	47	1 - 2 - 3 - 5 - 10	25/85	4000	1 - 2 - 3
TSM2A-503	50	1 - 2 - 3 - 5 - 10	25/85	4000	1 - 2 - 3
TSM2A-683	68	1 - 2 - 3 - 5 - 10	25/85	4020	1 - 2 - 3
TSM2A-104	100	1 - 2 - 3 - 5 - 10	25/85	3975	1 - 2 - 3

R-T CHARACTERISTIC CURVE

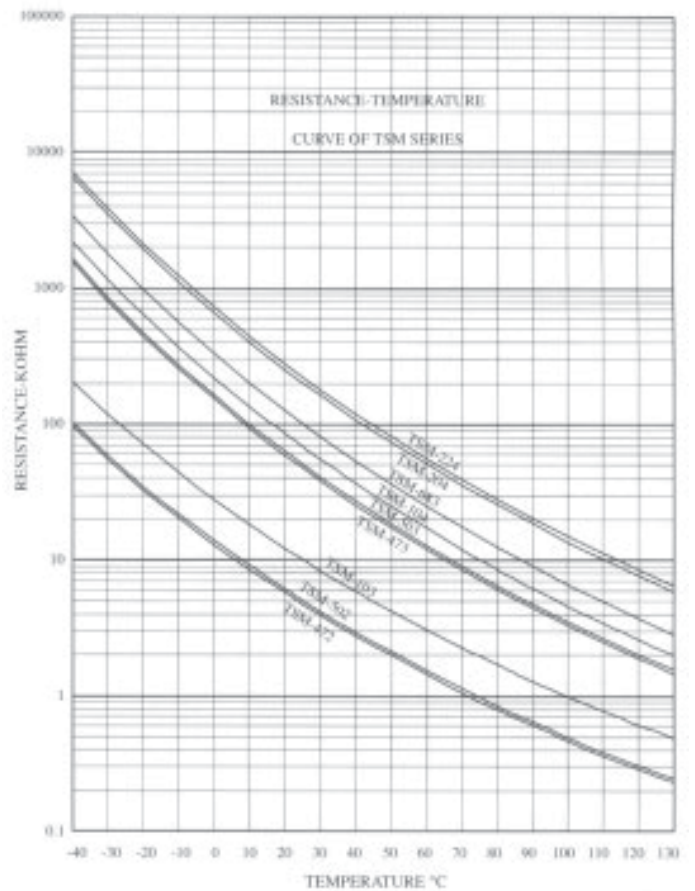

Thermal Dissipation Constant TSM1 ≥ 0.9mW/°C
TSM2 ≥ 1.0mW/°C

Thermal Time Constant TSM1 ≤ 5.0 Sec
TSM2 ≤ 7.5 Sec

Operating Temperature Range at Zero Power -40 ~ +125°C

TTC03-SERIES Part Number Code

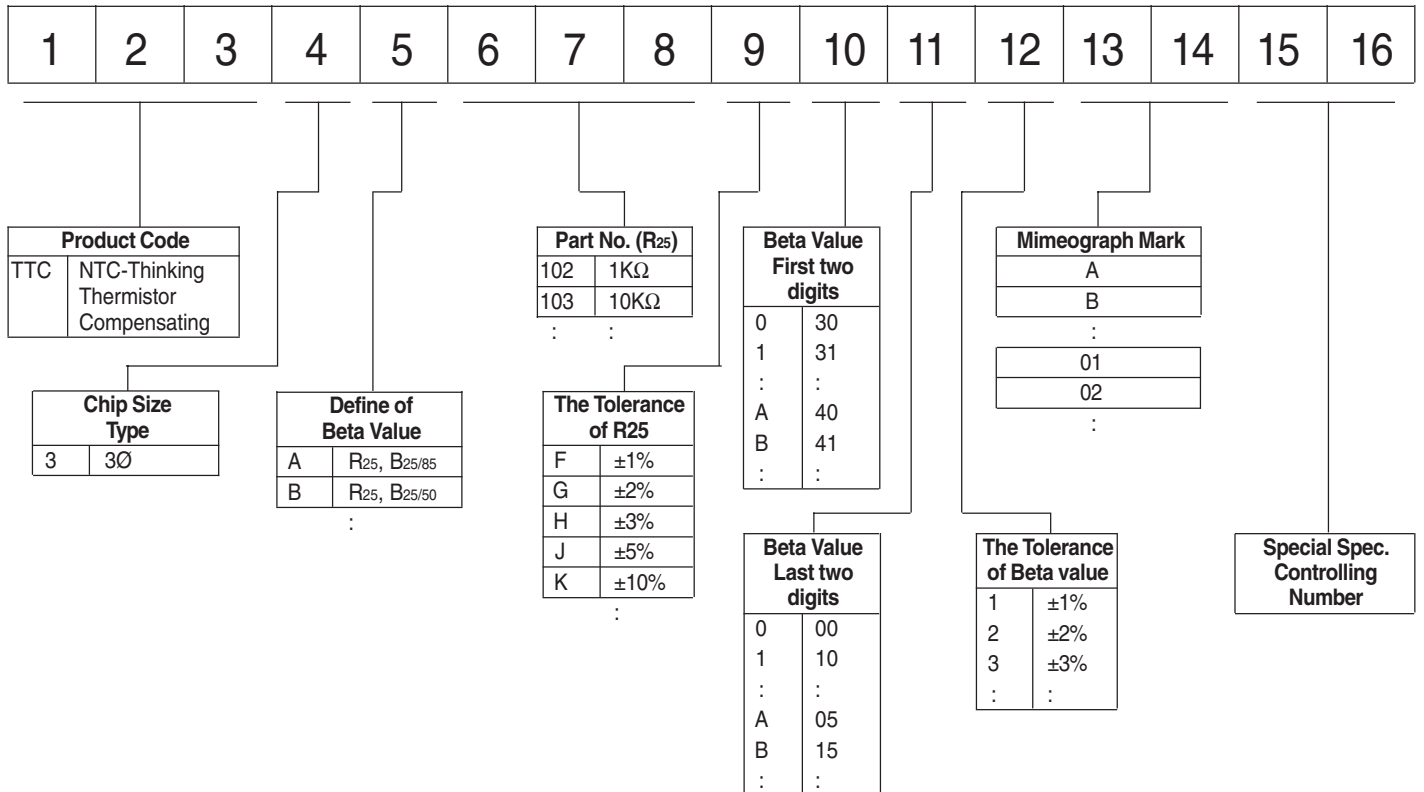

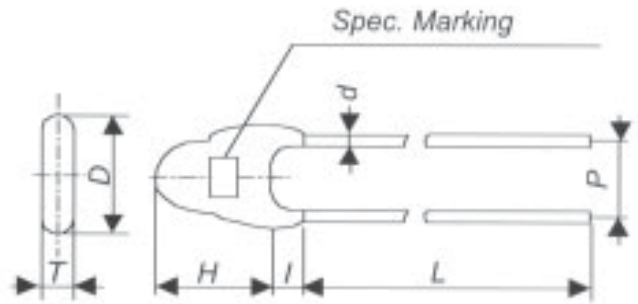

SPECIFICATION

Part No	Zero Power Resistance at 25°C (KΩ)	Tolerance of Resistance (±%)	B Value (K)	Tolerance of B Value (±%)	
TTC3A901-9D2	0.9	1 - 2 - 3 - 5 - 10	25/85	3935	2.0
TTC3A102-9D2	1	1 - 2 - 3 - 5 - 10	25/85	3935	2.0
TTC3A202-9LA	2	1 - 2 - 3 - 5 - 10	25/85	3977	1.5
TTC3A222-9LA	2.2	1 - 2 - 3 - 5 - 10	25/85	3977	1.5
TTC3A272-9LA	2.7	1 - 2 - 3 - 5 - 10	25/85	3977	1.5
TTC3A302-9LA	3	1 - 2 - 3 - 5 - 10	25/85	3977	1.5
TTC3A332-9LA	3.3	1 - 2 - 3 - 5 - 10	25/85	3977	1.5
TTC3A472-9LA	4.7	1 - 2 - 3 - 5 - 10	25/85	3977	1.5
TTC3A502-9LA	5	1 - 2 - 3 - 5 - 10	25/85	3977	1.5
TTC3A682-9LA	6.8	1 - 2 - 3 - 5 - 10	25/85	3977	1.5
TTC3A103-4D2	10	1 - 2 - 3 - 5 - 10	25/85	3435	2.0
TTC3A103-743	10	1 - 2 - 3 - 5 - 10	25/85	3740	3.0
TTC3A103-9LA	10	1 - 2 - 3 - 5 - 10	25/85	3977	1.5
TTC3B103-B02	10	1 - 2 - 3 - 5 - 10	25/50	4100	2.0
TTC3A123-743	12	1 - 2 - 3 - 5 - 10	25/85	3740	3.0
TTC3A153-743	15	1 - 2 - 3 - 5 - 10	25/85	3740	3.0
TTC3A203-743	20	1 - 2 - 3 - 5 - 10	25/85	3740	3.0
TTC3A223-743	22	1 - 2 - 3 - 5 - 10	25/85	3740	3.0
TTC3A333-A9A	33	1 - 2 - 3 - 5 - 10	25/85	4090	1.5
TTC3A473-A9A	47	1 - 2 - 3 - 5 - 10	25/85	4090	1.5
TTC3A683-B92	68	1 - 2 - 3 - 5 - 10	25/85	4190	2.0
TTC3A104-B92	100	1 - 2 - 3 - 5 - 10	25/85	4190	2.0
TTC3A154-D7B	150	1 - 2 - 3 - 5 - 10	25/85	4370	2.5
TTC3A224-D7B	220	1 - 2 - 3 - 5 - 10	25/85	4370	2.5
TTC3A334-F73	330	1 - 2 - 3 - 5 - 10	25/85	4570	3.0
TTC3A474-F73	470	1 - 2 - 3 - 5 - 10	25/85	4570	3.0
TTC3B474-J05	470	1 - 2 - 3 - 5 - 10	25/50	5200	5.0

DIMENSION

Unit.: mm

Dmax	Tmax	Hmax	Imax	Lmin	Pnol.	dnol
4	3	5	3	30	2.54±1.0	0.5±0.02

R-T CHARACTERISTIC CURVE

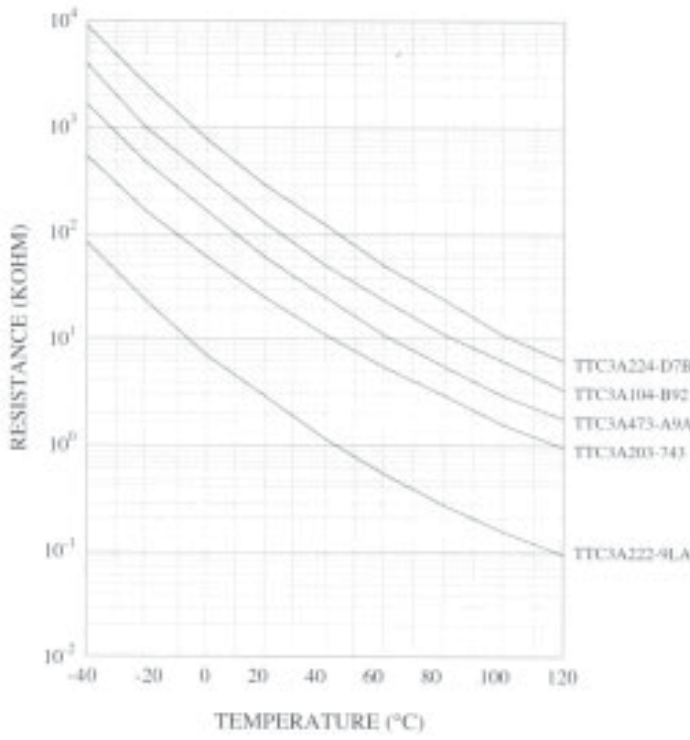

Thermal Dissipation Constant	≥ 5mW/°C
Thermal Time Constant	≤ 11 Sec
Maximum Dissipation	250mW
Operating Temperature Range at Zero Power	-40 to 125°C
at Maximum Power	0 to 55°C

TCF-SERIES Part Number Code

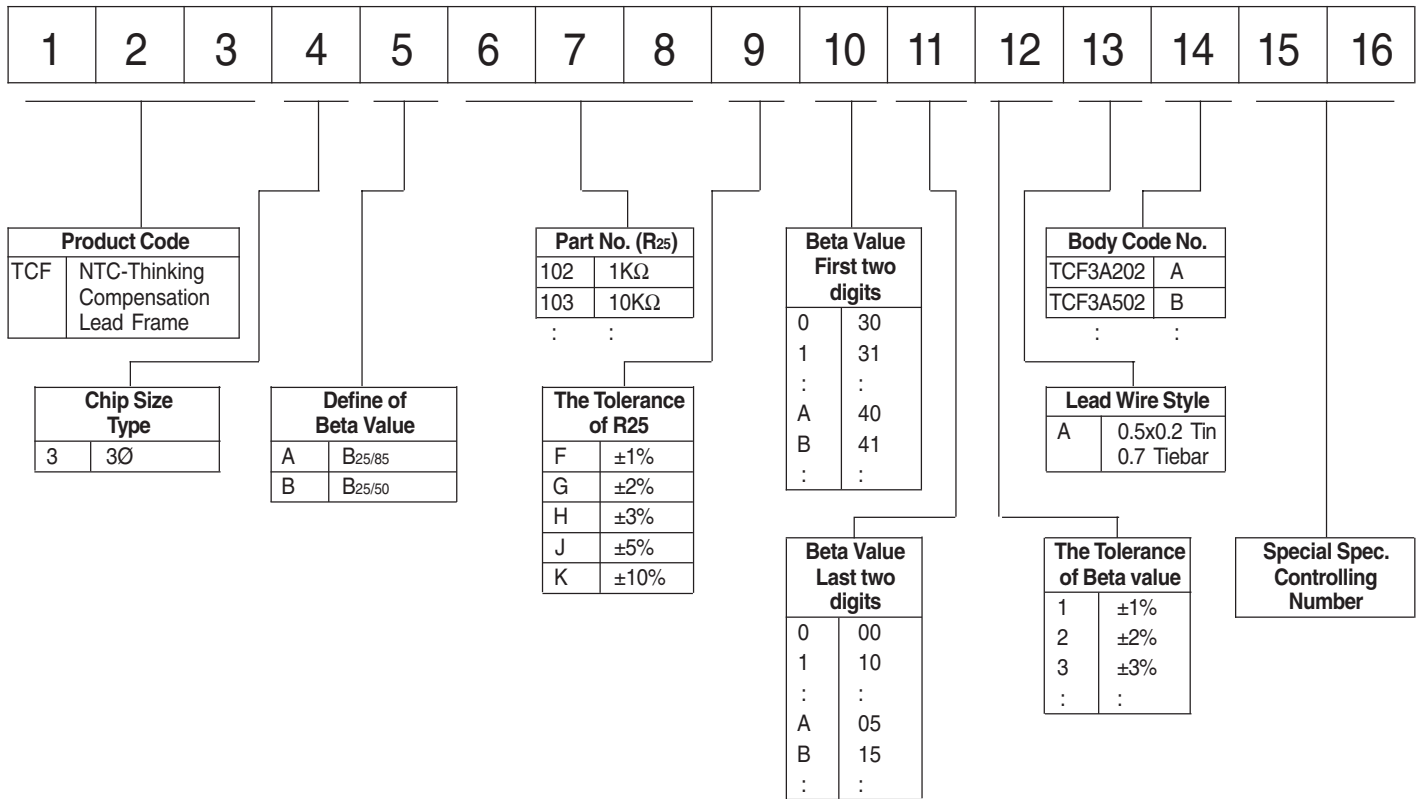

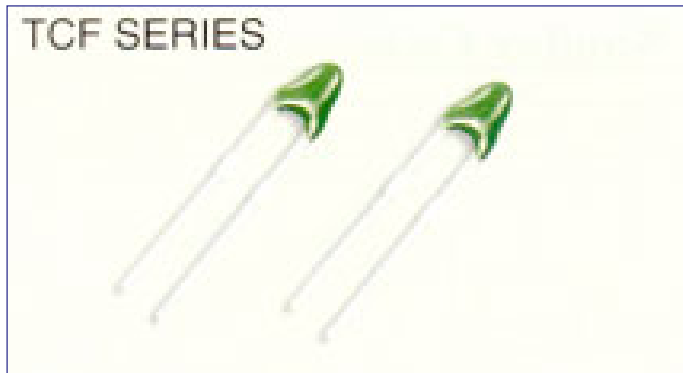

DIMENSION

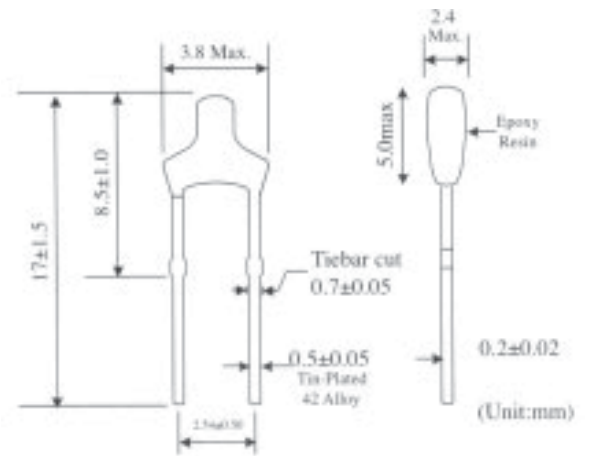

SPECIFICATION

Part No	Zero Power Resistance at 25°C (KΩ)	Tolerance of at 25°C (±%)	B Value (K)	Tolerance of B Value (±%)	Code of Part No
TCF-202	2	1 - 2 - 3 - 5 - 10	25/85	3182	1 - 2 - 3 - 5 A
TCF-502	5	1 - 2 - 3 - 5 - 10	25/85	3324	1 - 2 - 3 - 5 B
TCF-103	10	1 - 2 - 3 - 5 - 10	25/85	3435	1 - 2 - 3 - 5
TCF-123	12	1 - 2 - 3 - 5 - 10	25/85	3470	1 - 2 - 3 - 5 E
TCF-203	20	1 - 2 - 3 - 5 - 10	25/85	4013	1 - 2 - 3 - 5 F
TCF-303	30	1 - 2 - 3 - 5 - 10	25/85	4090	1 - 2 - 3 - 5 G
TCF-333	33	1 - 2 - 3 - 5 - 10	25/85	4090	1 - 2 - 3 - 5 H
TCF-473	47	1 - 2 - 3 - 5 - 10	25/85	4090	1 - 2 - 3 - 5 I
TCF-503	50	1 - 2 - 3 - 5 - 10	25/85	4060	1 - 2 - 3 - 5 J
TCF-104	100	1 - 2 - 3 - 5 - 10	25/85	4190	1 - 2 - 3 - 5 K

R-T CHARACTERISTIC CURVE

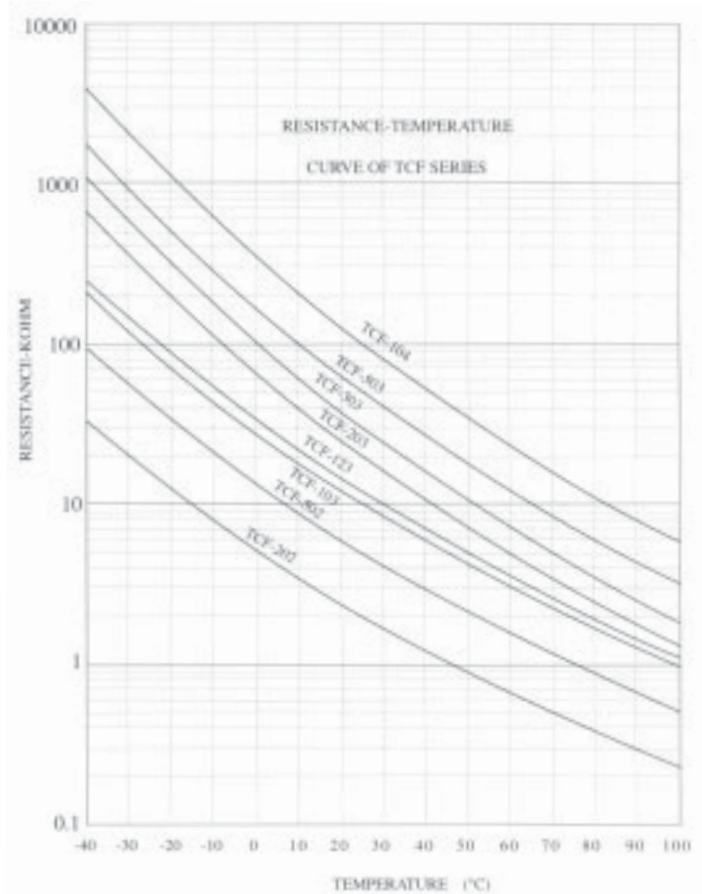

Thermal Dissipation Constant	2 mW/°C
Thermal Time Constant	12 Sec
Operating Temperature Range at Zero Power	-40 ~ +100°C

DHT-SERIES Part Number Code

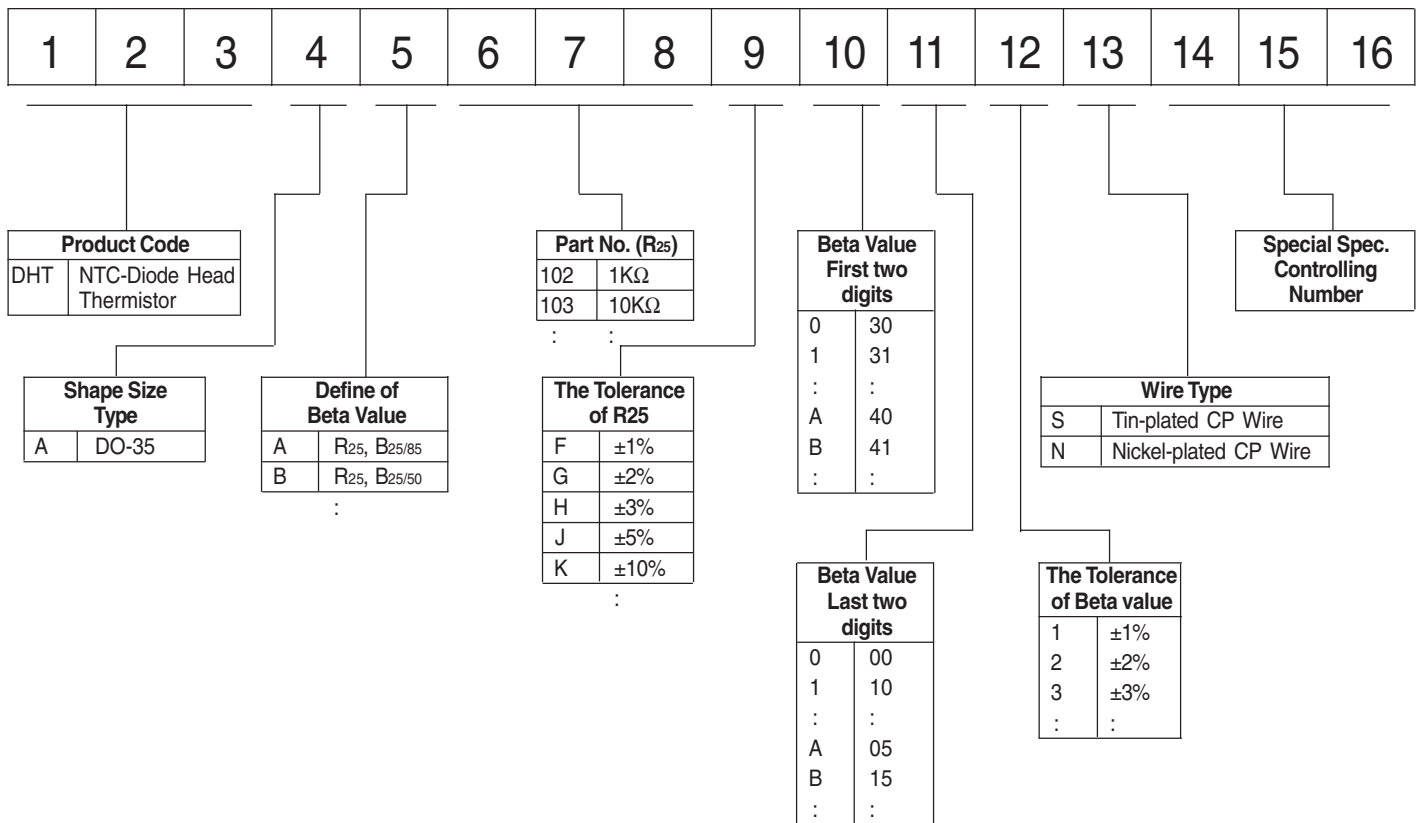

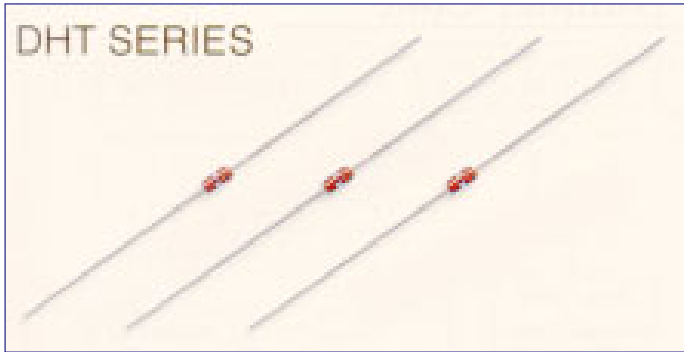

DIMENSION

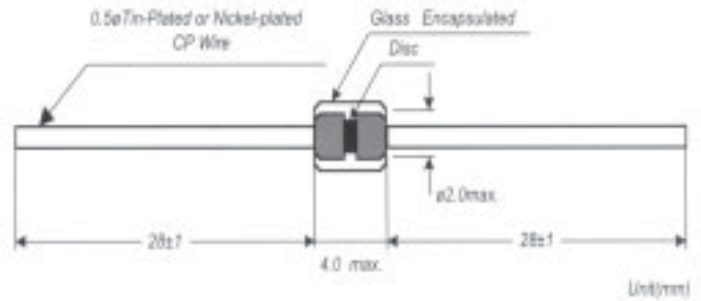

SPECIFICATION

Part No	Zero Power Resistance at 25°C (KΩ)	Tolerance of Resistance (±%)	B Value (K)	Tolerance of B Value (±%)	
DHTAB502-552	5	1 - 2 - 3 - 5 - 10	25/50	3550	2.0
DHTAB103-552	10	1 - 2 - 3 - 5 - 10	25/50	3550	2.0
DHTAB103-952	10	1 - 2 - 3 - 5 - 10	25/50	3950	2.0
DHTAA103-4D2	10	1 - 2 - 3 - 5 - 10	25/85	3435	2.0
DHTAA103-272	10	1 - 2 - 3 - 5 - 10	25/85	3270	2.0
DHTAA103-702	10	1 - 2 - 3 - 5 - 10	25/85	3700	2.0
DHTAB103-472	10	1 - 2 - 3 - 5 - 10	25/50	3470	2.0
DHTAA103-9L2	10	1 - 2 - 3 - 5 - 10	25/85	3977	2.0
DHTAB203-952	20	1 - 2 - 3 - 5 - 10	25/50	3950	2.0
DHTAB473-952	47	1 - 2 - 3 - 5 - 10	25/50	3950	2.0
DHTAB503-952	50	1 - 2 - 3 - 5 - 10	25/50	3950	2.0
DHTAB104-952	100	1 - 2 - 3 - 5 - 10	25/50	3950	2.0
DHTAB104-A02	100	1 - 2 - 3 - 5 - 10	25/50	4000	2.0
DHTAA104-9L2	100	1 - 2 - 3 - 5 - 10	25/85	3977	2.0
DHTAA104-D02	100	1 - 2 - 3 - 5 - 10	25/85	4300	2.0
DHTAB303-952	30	1 - 2 - 3 - 5 - 10	25/50	3950	2.0

R-T CHARACTERISTIC CURVE

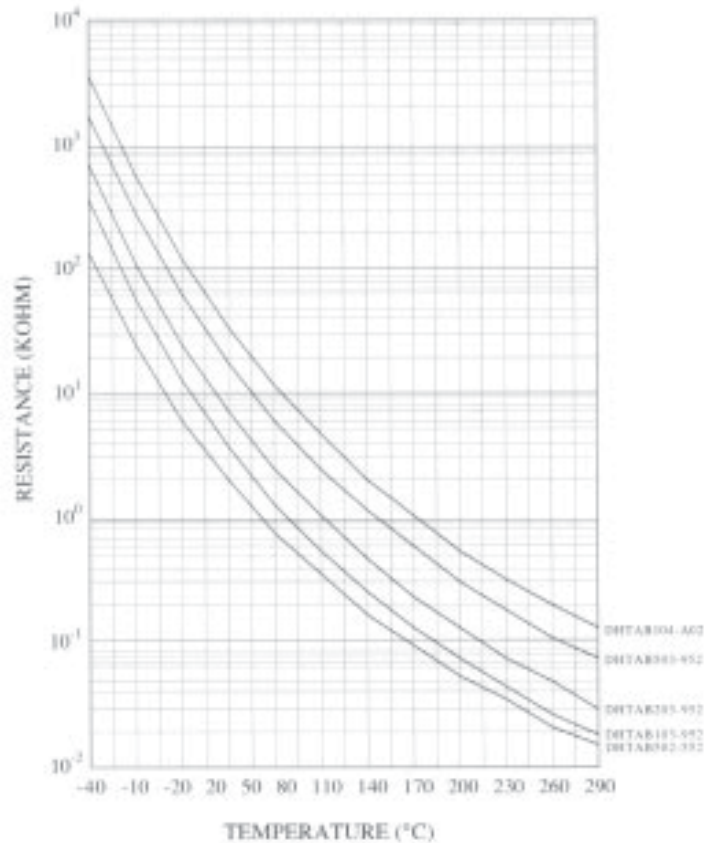

Thermal Dissipation Constant		> 2mW/°C
Thermal Time Constant		< 10sec
Operating Temperature Range at Zero Power	0.5ø Tin-plated CP wire	-40 to +200°C
Operating Temperature Range at Zero Power	0.5ø Nickel-plated CP wire	-40 to +300°C

TTF-SERIES Part Number Code

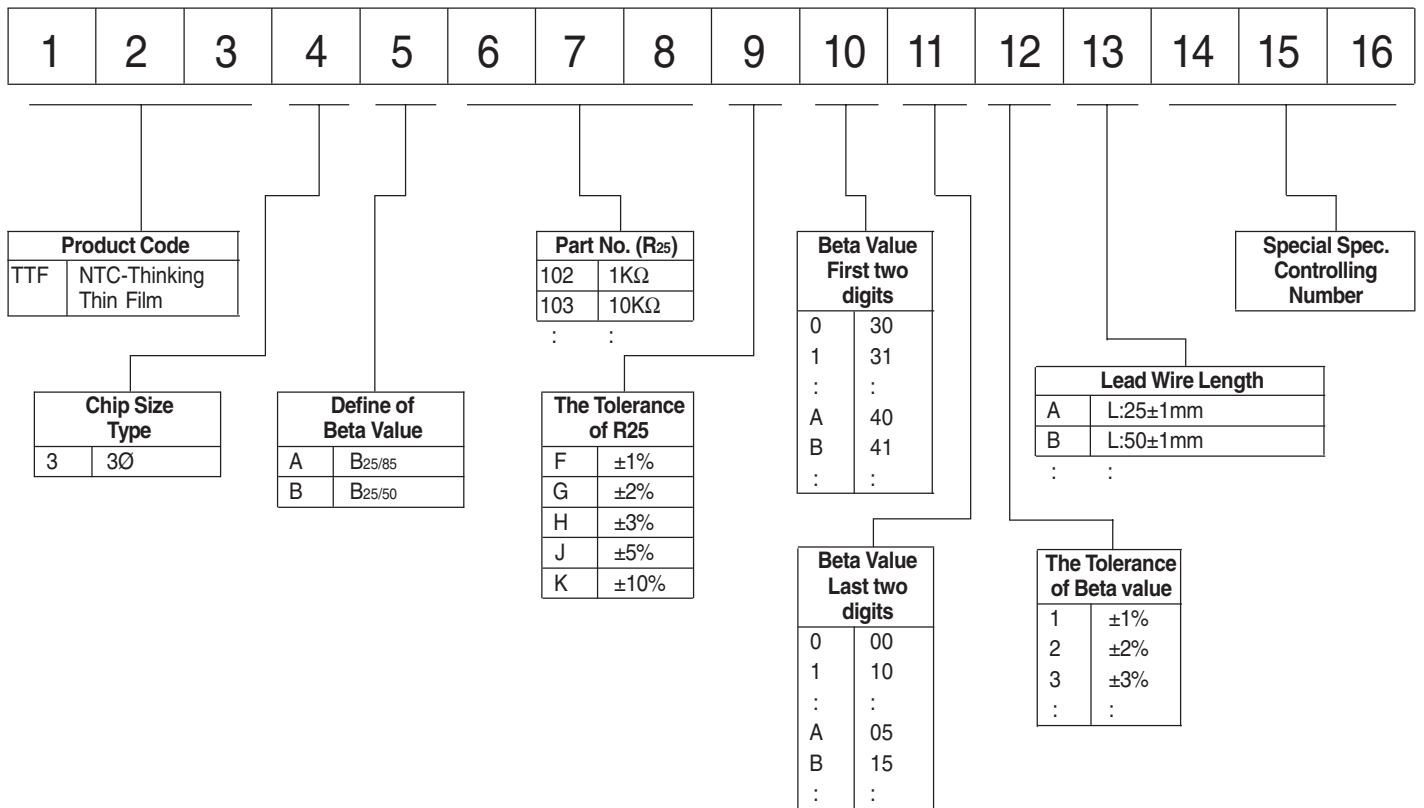



DIMENSION

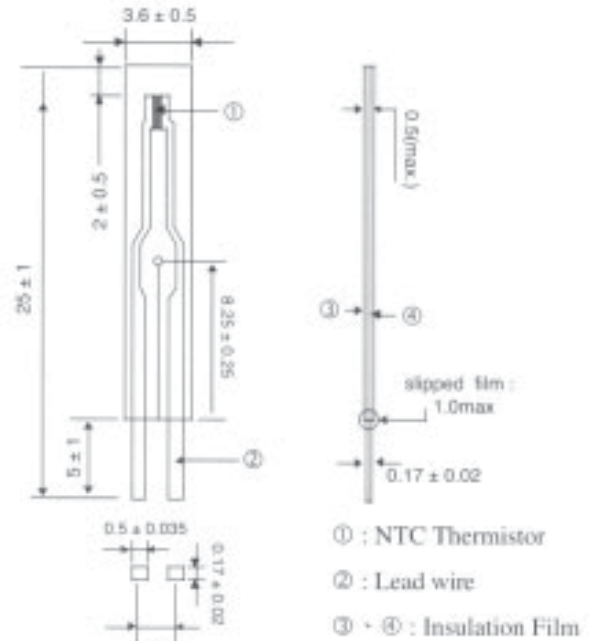

SPECIFICATION

Part No	Zero Power Resistance at 25°C (KΩ)	Tolerance of Resistance (±%)	B Value (K)	Tolerance of B Value (±%)
TTF-103	10	1 - 2 - 3 - 5 - 10	25/85 3435	1 - 2 - 3

Thermal Dissipation Constant (nor.)	0.7 mW/°C
Thermal Time Constant (nor.)	5 Sec
Operating Temperature Range at Zero Power	-40 ~ +100°C

R-T CHARACTERISTIC CURVE

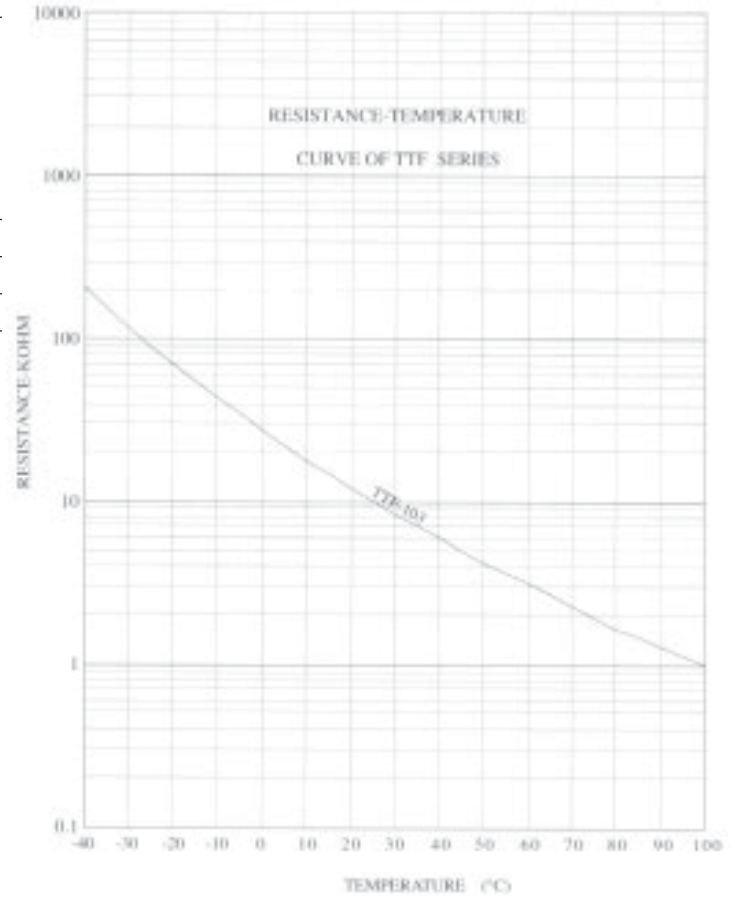



TTS-SERIES Part Number Code

1	2	3	4	5	6	7	8	9	10	11	12	13	14	15	16
---	---	---	---	---	---	---	---	---	----	----	----	----	----	----	----

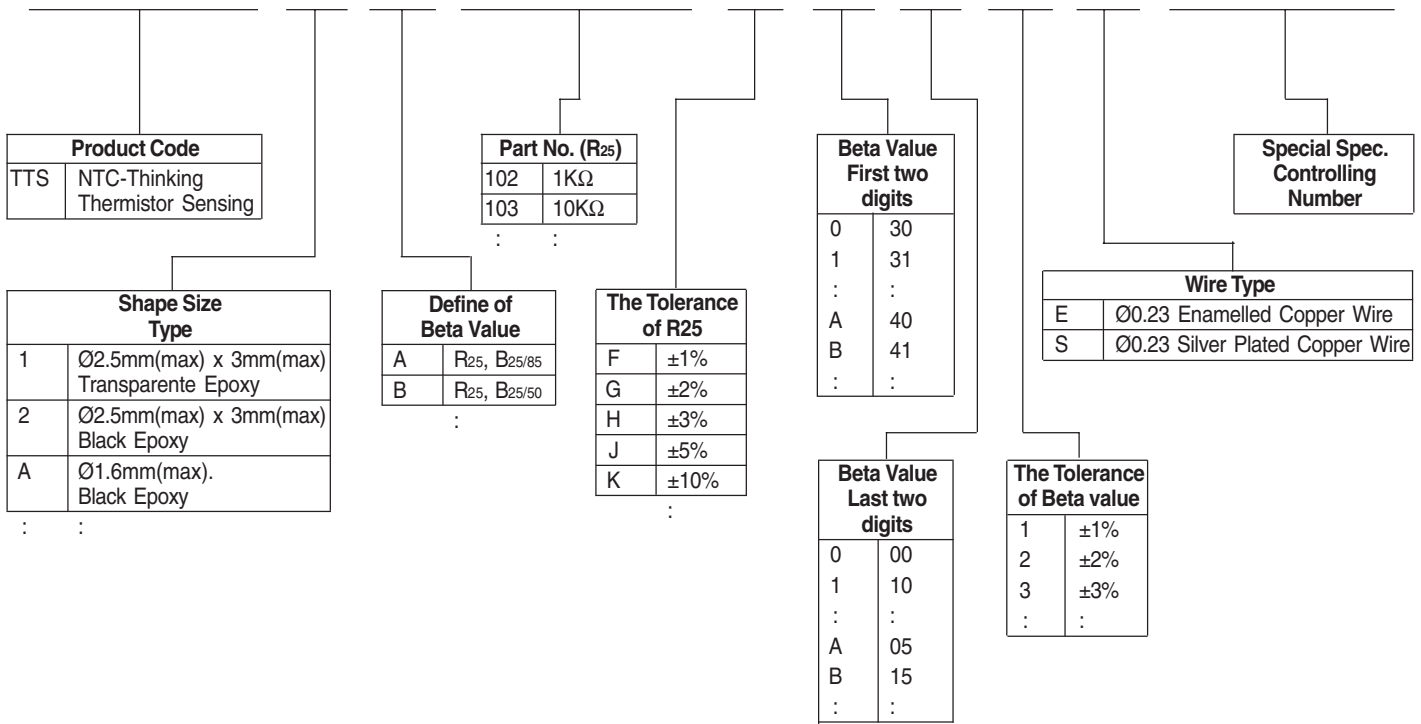

TTS SERIES

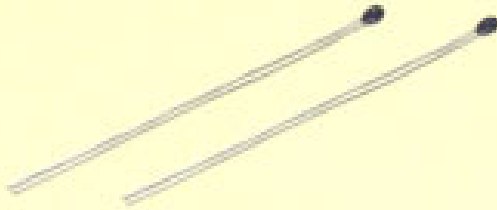

DIMENSION

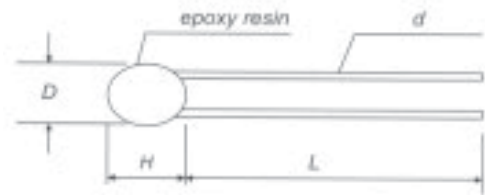

Unit.: mm

Wire	Dmax	Nmax	Lmin	dnom
Ag plated	2.5	3	40	0.25
Enamelled	2.5	3	80	0.25
Manganese	1.6	3	80	0.23

SPECIFICATION

Part No	Zero Power Resistance at 25°C (KW)	Tolerance of Resistance (±%)	B Value (K)	Tolerance of B Value (±%)	
TTS2B502-272	5	1 - 2 - 3 - 5 - 10	25/50	3270	2.0
TTS2B502-472	5	1 - 2 - 3 - 5 - 10	25/50	3470	2.0
TTS2B502-652	5	1 - 2 - 3 - 5 - 10	25/50	3650	2.0
TTS2B502-952	5	1 - 2 - 3 - 5 - 10	25/50	3950	2.0
TTS2B103-382	10	1 - 2 - 3 - 5 - 10	25/50	3380	2.0
TTS2B103-472	10	1 - 2 - 3 - 5 - 10	25/50	3470	2.0
TTS2B103-952	10	1 - 2 - 3 - 5 - 10	25/50	3950	2.0
TTS2A103-4D2	10	1 - 2 - 3 - 5 - 10	25/85	3435	2.0
TTS2A103-9L2	10	1 - 2 - 3 - 5 - 10	25/85	3977	2.0
TTS2B203-952	20	1 - 2 - 3 - 5 - 10	25/50	3950	2.0
TTS2A203-4D2	20	1 - 2 - 3 - 5 - 10	25/85	3435	2.0
TTS2B303-852	30	1 - 2 - 3 - 5 - 10	25/50	3850	2.0
TTS2A303-952	30	1 - 2 - 3 - 5 - 10	25/85	3950	2.0
TTS2B503-952	50	1 - 2 - 3 - 5 - 10	25/50	3950	2.0
TTS2A833-AB2	83	1 - 2 - 3 - 5 - 10	25/85	4015	2.0
TTS2B104-D02	100	1 - 2 - 3 - 5 - 10	25/50	4100	2.0
TTS2A503-4D2	50	1 - 2 - 3 - 5 - 10	25/85	3435	2.0
TTS2A504-C72	500	2 - 3 - 5 - 10	25/85	4270	2.0

R-T CHARACTERISTIC CURVE

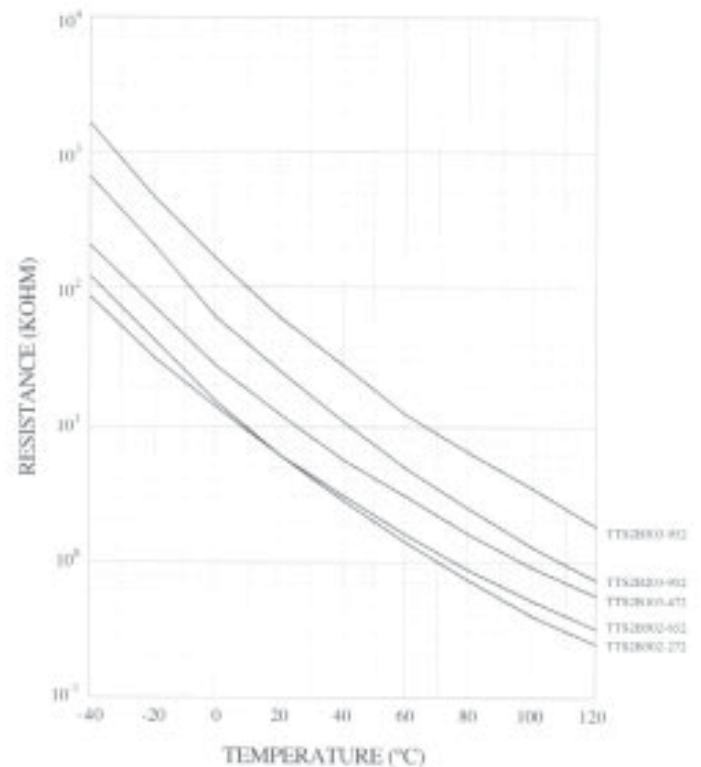

Thermal Dissipation Constant > 1.0mW/°C

Thermal Time Constant < 10 Sec

Operating Temperature Range at Zero Power -40 ~ +125°C