

## Automotive-grade silicon carbide Power MOSFET 1200 V, 15 mΩ typ., 129 A in an HiP247-4 package

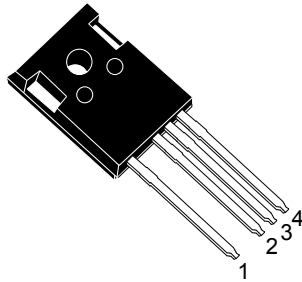

**HiP247-4**

ND1TPS2DS3G4

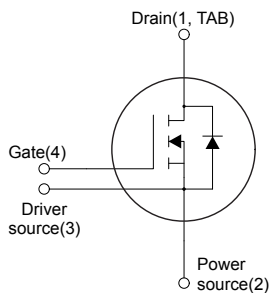

### Features

Order code	$V_{DS}$	$R_{DS(on)}$ typ.	$I_D$
SCT015W120G3-4AG	1200 V	15 mΩ	129 A

- AEC-Q101 qualified 
- Very fast and robust intrinsic body diode
- Extremely low gate charge and input capacitance
- Very high operating junction temperature capability ( $T_J = 200\text{ °C}$ )
- Source sensing pin for increased efficiency

### Applications

- Main inverter (electric traction)
- DC/DC converter for EV/HEV
- On board charger (OBC)

### Description

This silicon carbide Power MOSFET device has been developed using ST's advanced and innovative 3<sup>rd</sup> generation SiC MOSFET technology. The device features a very low  $R_{DS(on)}$  over the entire temperature range combined with low capacitances and very high switching operations, which improve application performance in frequency, energy efficiency, system size and weight reduction.

#### Product status link

[SCT015W120G3-4AG](#)

#### Product summary

<b>Order code</b>	SCT015W120G3-4AG
<b>Marking</b>	015W120G34AG
<b>Package</b>	HiP247-4
<b>Packing</b>	Tube

# 1 Electrical ratings

**Table 1. Absolute maximum ratings**

Symbol	Parameter	Value	Unit
$V_{DS}$	Drain-source voltage	1200	V
$V_{GS}$	Gate-source voltage	-10 to 22	V
	Gate-source voltage (recommended operating values)	-5 to 18	
	Gate-source transient voltage, $t_p < 1 \mu s$ , $t \leq 10$ hours over lifetime	-11 to 25	
$I_D^{(1)}$	Drain current (continuous) at $T_C = 25 \text{ }^\circ\text{C}$	129	A
	Drain current (continuous) at $T_C = 100 \text{ }^\circ\text{C}$	102	
$I_{DM}^{(2)}$	Drain current (pulsed)	404	A
$P_{TOT}$	Total power dissipation at $T_C = 25 \text{ }^\circ\text{C}$	673	W
$T_{stg}$	Storage temperature range	-55 to 200	$^\circ\text{C}$
$T_J$	Operating junction temperature range		$^\circ\text{C}$

- $I_D$  is limited by package.
- Pulse width is limited by safe operating area.

**Table 2. Thermal data**

Symbol	Parameter	Value	Unit
$R_{thJC}$	Thermal resistance, junction-to-case	0.26	$^\circ\text{C/W}$
$R_{thJA}$	Thermal resistance, junction-to-ambient	40	$^\circ\text{C/W}$

## 2 Electrical characteristics

$T_C = 25\text{ °C}$  unless otherwise specified.

**Table 3. On/off states**

Symbol	Parameter	Test conditions	Min.	Typ.	Max.	Unit
$V_{(BR)DSS}$	Drain-source breakdown voltage	$V_{GS} = 0\text{ V}$ , $I_D = 1\text{ mA}$	1200			V
$I_{DSS}$	Zero gate voltage drain current	$V_{GS} = 0\text{ V}$ , $V_{DS} = 1200\text{ V}$			10	$\mu\text{A}$
$I_{GSS}$	Gate-body leakage current	$V_{DS} = 0\text{ V}$ , $V_{GS} = -10\text{ to }22\text{ V}$			$\pm 100$	nA
$V_{GS(th)}$	Gate threshold voltage	$V_{DS} = V_{GS}$ , $I_D = 10\text{ mA}$	2.0	3.1	4.2	V
$R_{DS(on)}$	Static drain-source on-resistance	$V_{GS} = 15\text{ V}$ , $I_D = 60\text{ A}$		17.3		m $\Omega$
		$V_{GS} = 18\text{ V}$ , $I_D = 60\text{ A}$		15	20	
		$V_{GS} = 18\text{ V}$ , $I_D = 60\text{ A}$ , $T_J = 200\text{ °C}$		33		

**Table 4. Dynamic**

Symbol	Parameter	Test conditions	Min.	Typ.	Max.	Unit
$C_{iss}$	Input capacitance	$V_{DS} = 800\text{ V}$ , $f = 1\text{ MHz}$ , $V_{GS} = 0\text{ V}$	-	3512	-	pF
$C_{oss}$	Output capacitance		-	183	-	pF
$C_{riss}$	Reverse transfer capacitance		-	28	-	pF
$Q_g$	Total gate charge	$V_{DD} = 800\text{ V}$ , $V_{GS} = -5\text{ to }18\text{ V}$ , $I_D = 60\text{ A}$	-	167	-	nC
$Q_{gs}$	Gate-source charge		-	45	-	nC
$Q_{gd}$	Gate-drain charge		-	59	-	nC
$R_g$	Gate input resistance	$f = 1\text{ MHz}$ , $I_D = 0\text{ A}$	-	1.6	-	$\Omega$

**Table 5. Switching energy (inductive load)**

Symbol	Parameter	Test conditions	Min.	Typ.	Max.	Unit
$E_{on}$	Turn-on switching energy	$V_{DD} = 800\text{ V}$ , $I_D = 60\text{ A}$ ,	-	844	-	$\mu\text{J}$
$E_{off}$	Turn-off switching energy	$R_G = 4.7\text{ }\Omega$ , $V_{GS} = -5\text{ V to }18\text{ V}$	-	835	-	$\mu\text{J}$

**Table 6. Switching times**

Symbol	Parameter	Test conditions	Min.	Typ.	Max.	Unit
$t_{d(on)}$	Turn-on delay time	$V_{DD} = 800\text{ V}$ , $I_D = 60\text{ A}$ , $R_G = 4.7\text{ }\Omega$ , $V_{GS} = -5\text{ to }18\text{ V}$	-	22	-	ns
$t_r$	Rise time		-	9	-	ns
$t_{d(off)}$	Turn-off delay time		-	52	-	ns
$t_f$	Fall time		-	27	-	ns

**Table 7. Reverse SiC diode characteristics**

Symbol	Parameter	Test conditions	Min.	Typ.	Max.	Unit
$I_{SD}^{(1)}$	Continuous diode forward current	$T_C = 25\text{ }^\circ\text{C}$	-		129	A
		$T_C = 100\text{ }^\circ\text{C}$	-		102	
$V_{SD}$	Diode forward voltage	$I_{SD} = 60\text{ A}$ , $V_{GS} = 0\text{ V}$	-	3.6		V
$t_{rr}$	Reverse recovery time	$I_{SD} = 60\text{ A}$ , $di/dt = 1000\text{ A}/\mu\text{s}$ , $V_{DD} = 800\text{ V}$	-	23		ns
$Q_{rr}$	Reverse recovery charge		-	250		nC
$I_{RRM}$	Reverse recovery current		-	19		A

1.  $I_{SD}$  is limited by package.

## 2.1 Electrical characteristics (curves)

Figure 1. Safe operating area

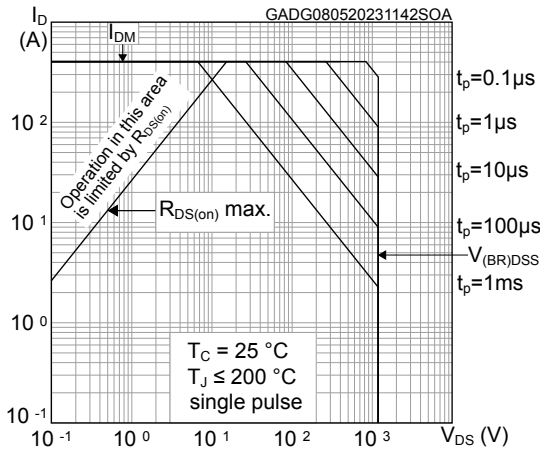

Figure 2. Maximum transient thermal impedance

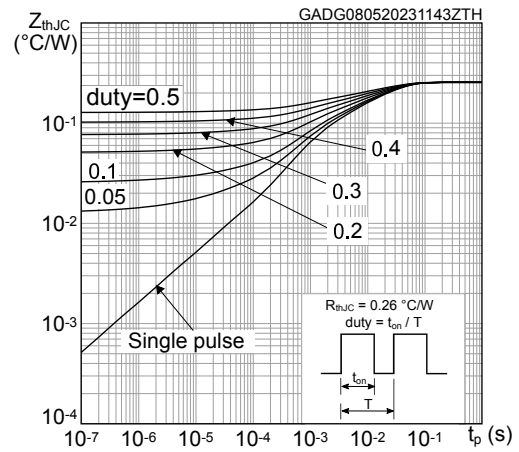

Figure 3. Typical output characteristics ( $T_J = 25\text{ °C}$ )

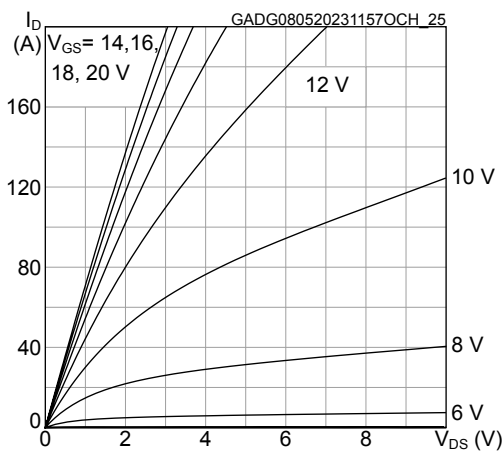

Figure 4. Typical output characteristics ( $T_J = 200\text{ °C}$ )

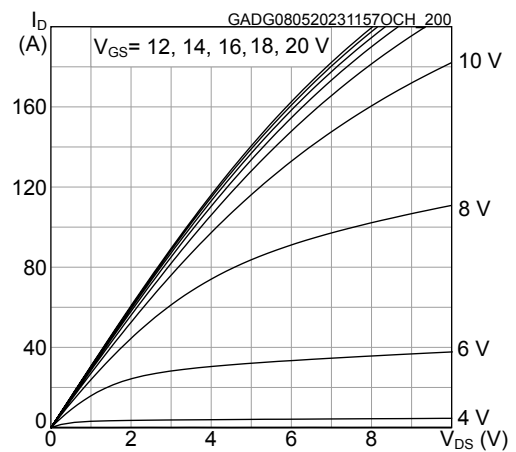

Figure 5. Typical transfer characteristics

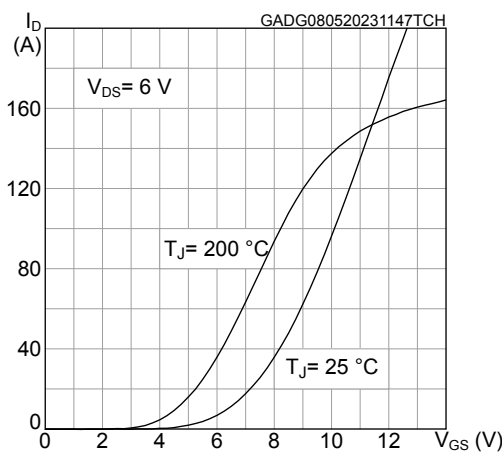

Figure 6. Total power dissipation

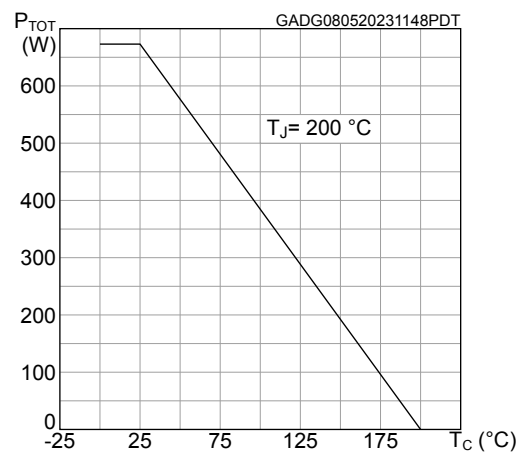

Figure 7. Typical gate charge characteristics

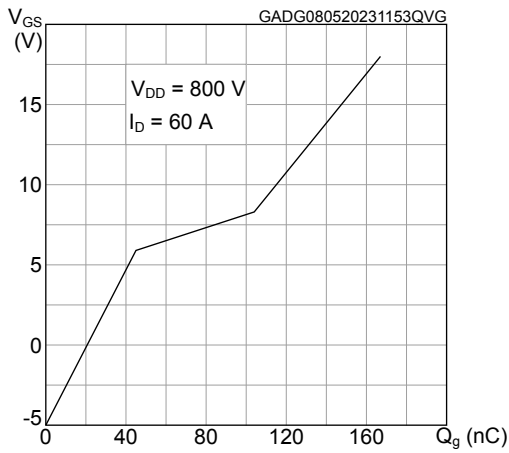

Figure 8. Typical capacitance characteristics

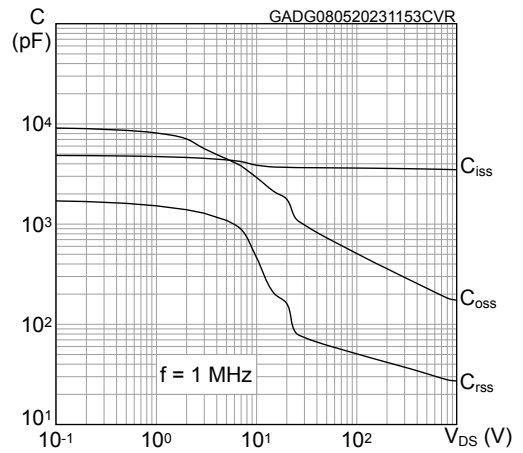

Figure 9. Typical switching energy vs supply voltage

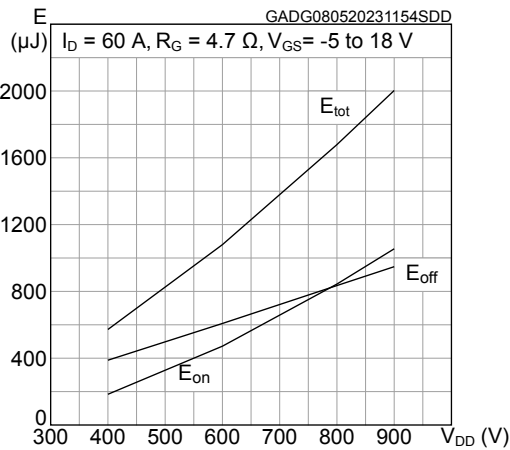

Figure 10. Typical switching energy vs drain current

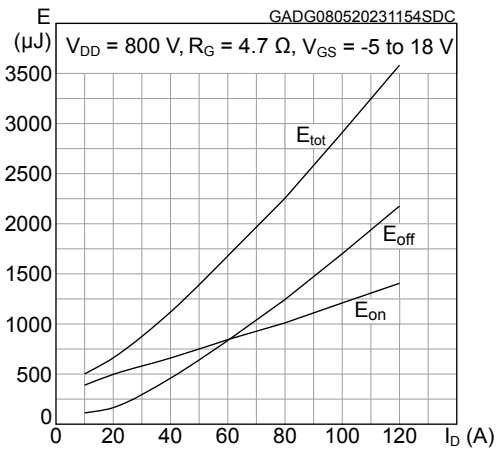

Figure 11. Typical switching energy vs gate resistance

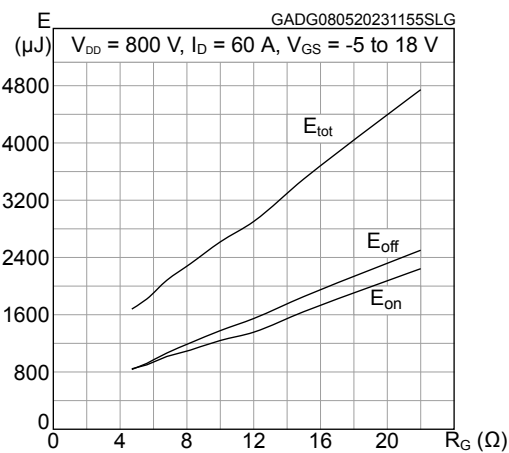

Figure 12. Normalized breakdown voltage vs temperature

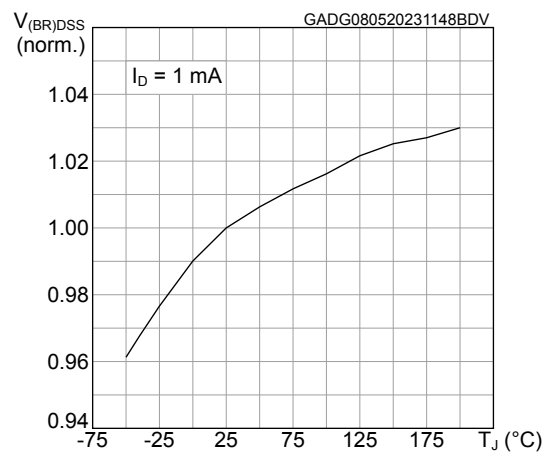

Figure 13. Normalized gate threshold vs temperature

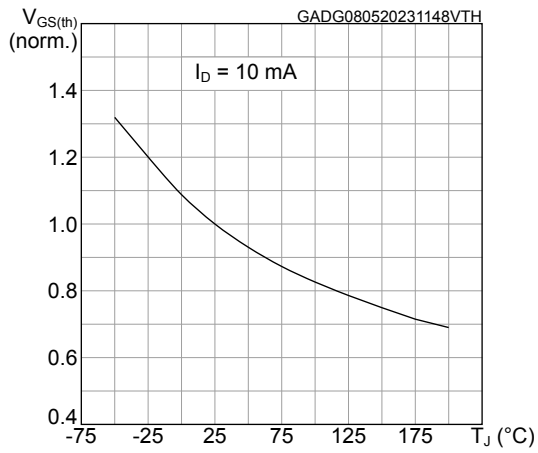

Figure 14. Normalized on-resistance vs temperature

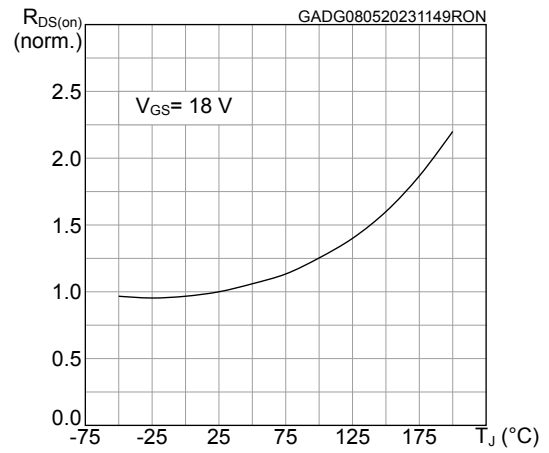

Figure 15. Typical reverse conduction characteristics ( $T_J = 25 \text{ }^\circ\text{C}$ )

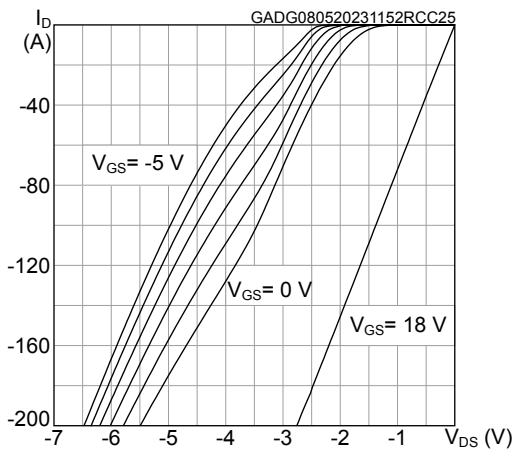
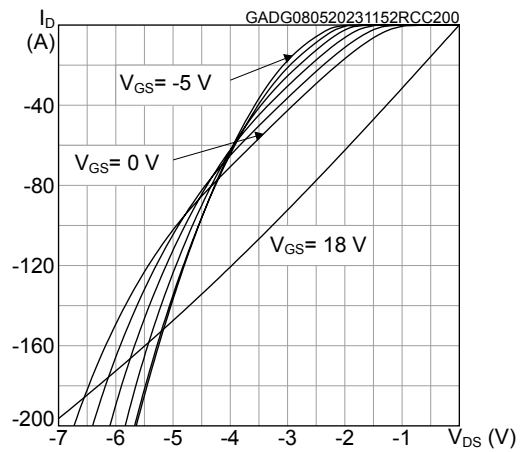

Figure 16. Typical reverse conduction characteristics ( $T_J = 200 \text{ }^\circ\text{C}$ )



### 3 Package information

In order to meet environmental requirements, ST offers these devices in different grades of **ECOPACK** packages, depending on their level of environmental compliance. ECOPACK specifications, grade definitions and product status are available at: [www.st.com](http://www.st.com). ECOPACK is an ST trademark.

#### 3.1 HiP247-4 package information

Figure 17. HiP247-4 package outline

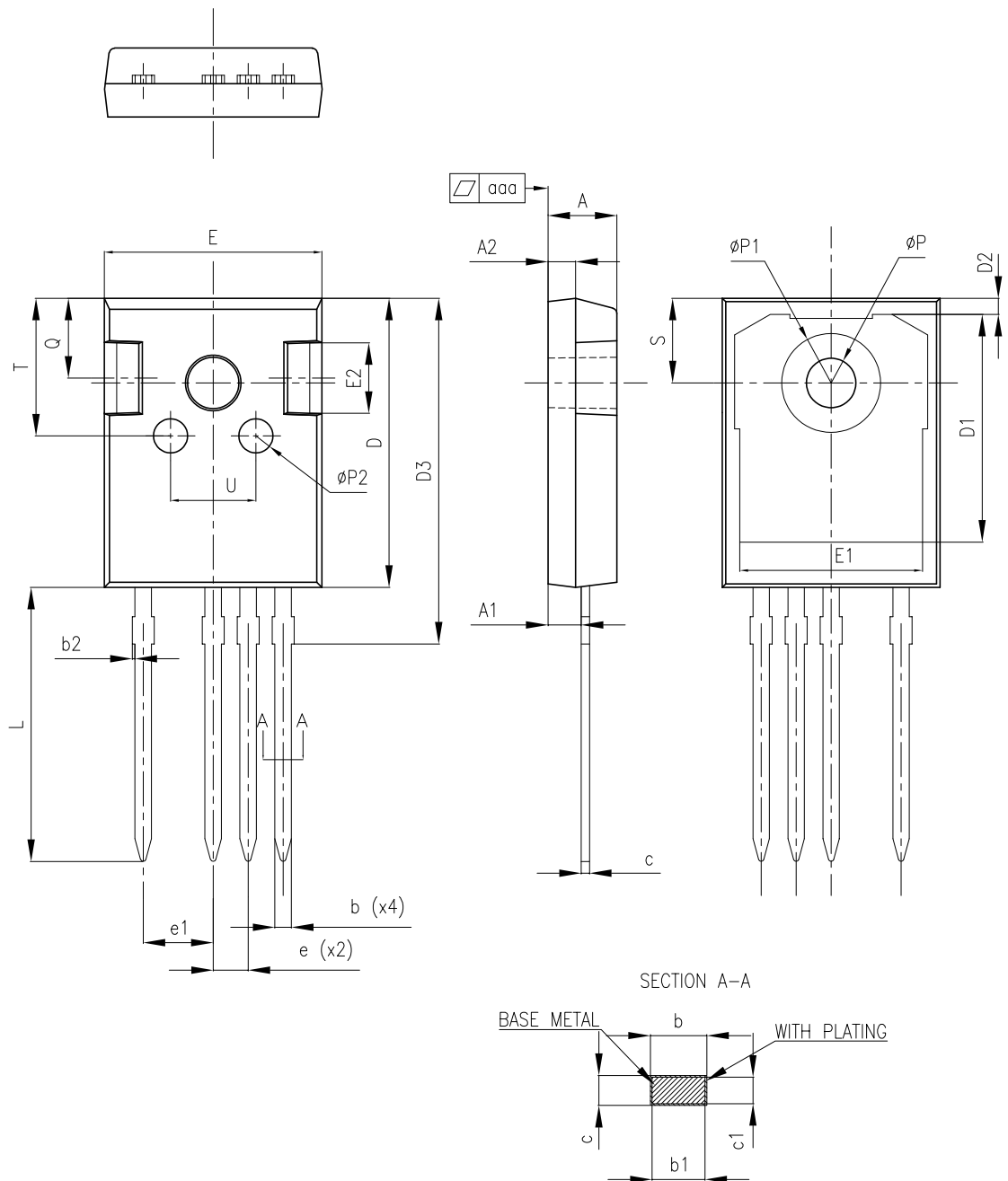



**Table 8. HiP247-4 mechanical data**

Dim.	mm		
	Min.	Typ.	Max.
A	4.90	5.00	5.10
A1	2.31	2.41	2.51
A2	1.90	2.00	2.10
b	1.16		1.29
b1	1.15	1.20	1.25
b2	0		0.20
c	0.59		0.66
c1	0.58	0.60	0.62
D	20.90	21.00	21.10
D1	16.25	16.55	16.85
D2	1.05	1.20	1.35
D3	24.97	25.12	25.27
E	15.70	15.80	15.90
E1	13.10	13.30	13.50
E2	4.90	5.00	5.10
E3	2.40	2.50	2.60
e	2.44	2.54	2.64
e1	4.98	5.08	5.18
L	19.80	19.92	20.10
P	3.50	3.60	3.70
P1			7.40
P2	2.40	2.50	2.60
Q	5.60		6.00
S		6.15	
T	9.80		10.20
U	6.00		6.40
aaa		0.04	0.10

## Revision history

**Table 9. Document revision history**

Date	Revision	Changes
16-May-2023	1	First release.
06-Dec-2023	2	Updated <a href="#">Table 3</a> . On/off states.

---

## Contents

<b>1</b>	<b>Electrical ratings</b> .....	<b>2</b>
<b>2</b>	<b>Electrical characteristics</b> .....	<b>3</b>
<b>2.1</b>	<b>Electrical characteristics (curves)</b> .....	<b>5</b>
<b>3</b>	<b>Package information</b> .....	<b>8</b>
<b>3.1</b>	<b>HiP247-4 package information</b> .....	<b>8</b>
	<b>Revision history</b> .....	<b>10</b>

**IMPORTANT NOTICE – READ CAREFULLY**

STMicroelectronics NV and its subsidiaries (“ST”) reserve the right to make changes, corrections, enhancements, modifications, and improvements to ST products and/or to this document at any time without notice. Purchasers should obtain the latest relevant information on ST products before placing orders. ST products are sold pursuant to ST’s terms and conditions of sale in place at the time of order acknowledgment.

Purchasers are solely responsible for the choice, selection, and use of ST products and ST assumes no liability for application assistance or the design of purchasers’ products.

No license, express or implied, to any intellectual property right is granted by ST herein.

Resale of ST products with provisions different from the information set forth herein shall void any warranty granted by ST for such product.

ST and the ST logo are trademarks of ST. For additional information about ST trademarks, refer to [www.st.com/trademarks](http://www.st.com/trademarks). All other product or service names are the property of their respective owners.

Information in this document supersedes and replaces information previously supplied in any prior versions of this document.

© 2023 STMicroelectronics – All rights reserved