

## 2.8V-6V Vin 3A Synchronous Step Down Convertor

### FEATURES

- Input Voltage Range: 2.8V-6V
- Up to 3A Continuous Output Current
- Low Shutdown Current: 0.7uA
- 0.6±1% Feedback Reference Voltage
- 2.1MHz Switching Frequency
- Integrated 25mΩ High-Side and 20mΩ Low-Side Power MOSFETs
- Adjustable output voltage from 0.6V to 5V
- Active output discharge
- Programmable Soft Start Time
- Power Good Indicator
- Integrated Protection Feature
  - Cycle-by-cycle current limit
  - Under-voltage Lockout
  - HICCUP Over Current Protection
  - Thermal Shutdown Protection:160°C
- QFN-8L 1.5mm\*2mm Package
- Available in a Wettable Flank Package

### APPLICATIONS

- Automotive Infotainment
- Battery-Powered Devices
- Solid state driver
- Automotive Infotainment

### DESCRIPTION

The SCT2130 is a monolithic, step-down switch-mode converter with built-in internal 25mΩ High-Side and 20mΩ Low-Side Power MOSFETs. The device achieves 3A of continuous output current from a 2.8V to 6V input voltage range, with excellent load and line regulation. The output voltage can be regulated to as low as 0.6V.

The SCT2130, adopting the constant-on time (COT) mode control provides fast transient response and eases loop stabilization, greatly simplifies the converter off-chip configuration.

The SCT2130 features programmable soft-start time to avoid large inrush current and output voltage overshoot during startup. The SCT2130 operates in Forced Continuous Conduction Mode (FCCM) to achieve low light load ripple. The switching frequency is fixed 2.1MHz.

It includes full protection features, such as cycle-by-cycle current limit and hiccup over current protection, output under-voltage protection, input under-voltage lockout, and thermal shutdown.

The SCT2130 requires a minimal number of external components and is available in a space-saving QFN-8L 1.5mm\*2mm package with Wettable Flank.

### TYPICAL APPLICATION

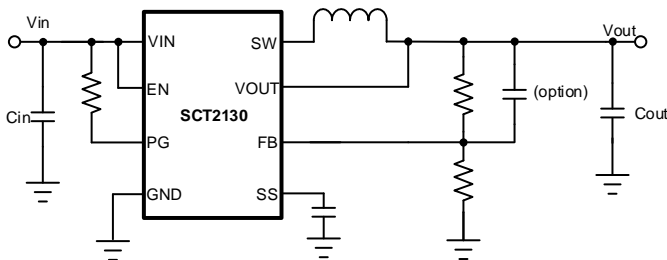

2.8V-6V, Synchronous Buck Converter

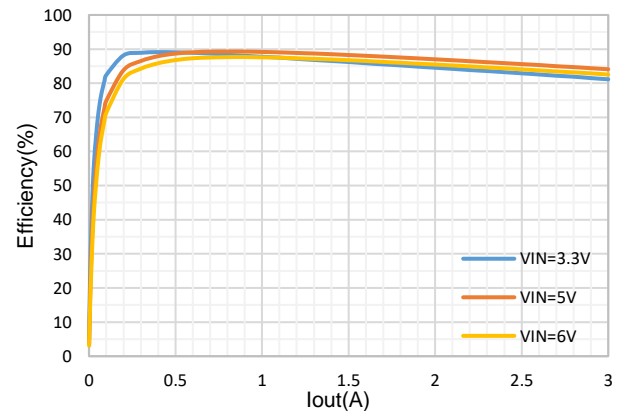

Efficiency, Vout=1.2V

# SCT2130

## REVISION HISTORY

Revision 1.0: Release to production.

## DEVICE ORDER INFORMATION

PART NUMBER	PACKAGE MARKING	PACKAGE DISCRIPTION
SCT2130FTA	2130	QFN-8L1.5mm*2mm

1) For Tape & Reel, Add Suffix R (e.g. SCT2130FTAR)

## ABSOLUTE MAXIMUM RATINGS

Over operating free-air temperature unless otherwise noted <sup>(1)</sup>

DESCRIPTION	MIN	MAX	UNIT
VIN, EN, PG, SW, VOUT	-0.3	7	V
SS, FB	-0.3	5.5	V
Operating junction temperature T <sub>J</sub> <sup>(2)</sup>	-40	150	°C
Storage temperature T <sub>STG</sub>	-65	150	°C

## PIN CONFIGURATION

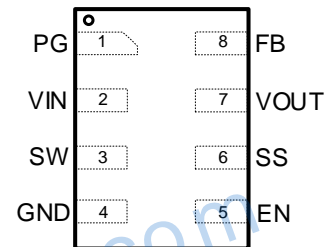

Top View: QFN-8L 1.5mm x 2mm, Plastic

- (1) Stresses beyond those listed under Absolute Maximum Rating may cause device permanent damage. The device is not guaranteed to function outside of its Recommended Operation Conditions.
- (2) The IC includes over temperature protection to protect the device during overload conditions. Junction temperature will exceed 150°C when over temperature protection is active. Continuous operation above the specified maximum operating junction temperature will reduce lifetime.

## PIN FUNCTIONS

NAME	NO.	PIN FUNCTION
PG	1	Power-good indicator. An open-drain output which goes low if FB is below the under voltage threshold. Connect a pullup resistor to the system voltage rail.
VIN	2	Power supply input pin.
SW	3	Switch output. SW is driven up to VIN through the high-side power MOSFET during on-time. The inductor current drives SW to negative voltage through low-side power MOSFET during off-time.
GND	4	Ground pin.
EN	5	Enable logic input. Connect high to enable device.
SS	6	Soft-start time programming pin. An external capacitor and an internal current source set the ramp rate of the internal error amplifier reference during soft start.
VOUT	7	Output Pin.
FB	8	Inverting input of the error amplifier. Connect a voltage divider from the output to this pin to set output voltage.

**RECOMMENDED OPERATING CONDITIONS**

Over operating free-air temperature range unless otherwise noted

PARAMETER	DEFINITION	MIN	MAX	UNIT
V <sub>IN</sub>	Input voltage range	2.8	6	V
V <sub>OUT</sub>	Output voltage range	0.6	5	V
T <sub>J</sub>	Operating junction temperature	-40	125	°C

**ESD RATINGS**

PARAMETER	DEFINITION	MIN	MAX	UNIT
V <sub>ESD</sub>	Human Body Model (HBM), per ANSI-JEDEC-JS-001-2014 specification, all pins <sup>(1)</sup>	-3	+3	kV
	Charged Device Model (CDM), per ANSI-JEDEC-JS-002-2014 specification, all pins <sup>(1)</sup>	-1	+1	kV

(1) HBM and CDM stressing are done in accordance with the ANSI/ESDA/JEDEC JS-001-2014 specification.

**THERMAL INFORMATION**

PARAMETER	THERMAL METRIC	QFN-8L	UNIT
R <sub>θJA</sub>	Junction to ambient thermal resistance <sup>(1)</sup>	90.5	°C/W
Ψ <sub>JT</sub>	Junction-to-top characterization parameter	5.77	
Ψ <sub>JB</sub>	Junction-to-board characterization parameter <sup>(1)</sup>	10.7	
R <sub>θJctop</sub>	Junction to case thermal resistance <sup>(1)</sup>	124.4	
R <sub>θJB</sub>	Junction-to-board thermal resistance <sup>(1)</sup>	10.9	

(1) SCT provides R<sub>θJA</sub> and R<sub>θJC</sub> numbers only as reference to estimate junction temperatures of the devices. R<sub>θJA</sub> and R<sub>θJC</sub> are not a characteristic of package itself, but of many other system level characteristics such as the design and layout of the printed circuit board (PCB) on which the SCT2130 is mounted, thermal pad size, and external environmental factors. The PCB board is a heat sink that is soldered to the leads and thermal pad of the SCT2130. Changing the design or configuration of the PCB board changes the efficiency of the heat sink and therefore the actual R<sub>θJA</sub> and R<sub>θJC</sub>.

# SCT2130

## ELECTRICAL CHARACTERISTICS

$V_{IN}=5V$ ,  $T_J=-40^{\circ}C\sim 125^{\circ}C$ , typical values are tested under  $25^{\circ}C$ .

SYMBOL	PARAMETER	TEST CONDITION	MIN	TYP	MAX	UNIT
<b>Power Supply and Output</b>						
$V_{IN}$	Operating input voltage		2.8		6	V
$V_{IN\_UVLO}$	Input UVLO Hysteresis	$V_{IN}$ rising		2.7 175		V mV
$I_{SD}$	Shutdown current			700		nA
$I_Q$	Quiescent current from $V_{IN}$	no load, no switching		1000		uA
$V_{FB}$	Reference voltage of FB	$T_J=25^{\circ}C$	0.594	0.6	0.606	V
$I_{FB}$	FB pin leakage current				100	nA
$V_{UVP}$	Undervoltage protection of reference voltage			433		mV
<b>Power switch</b>						
$R_{HS}$	High-side switch on resistance			25		m $\Omega$
$R_{LS}$	Low-side switch on resistance			20		m $\Omega$
$I_{LIM\_HS}$	High-side peak current limit		3.8	4.5	5.2	A
$I_{LIM\_LS}$	High-side peak current limit		3.05	3.5		A
<b>Soft start</b>						
$I_{SS}$	Soft-start Current			3		uA
$R_{SS}$	SS pull down resistance			85		$\Omega$
<b>EN &amp; PG</b>						
$V_{ENH}$	High-level Threshold voltage		1.2			V
$V_{ENL}$	Low-level Threshold voltage				0.4	V
$R_{EN}$	EN Pull down resistance			2		M $\Omega$
$R_{DIS}$	Output Discharge resistance			80		$\Omega$
$V_{PGTL}$	Power Good Lower Threshold voltage	FB rising (Reference to $V_{FB}$ )		95		%
		FB falling (Reference to $V_{FB}$ )		90		%
$V_{PGTH}$	Power Good Upper Threshold voltage	FB rising (Reference to $V_{FB}$ )		110		%
		FB falling (Reference to $V_{FB}$ )		105		%
$V_{PGTL}$	Power Good Logic Low Level Voltage	$I_{PG}=-1mA$			0.4	V
$T_{PGD}$	Power Good Delay			80		uS
<b>Switching Frequency</b>						
$F_{SW}$	Switching frequency	$V_{in}=5V, V_{out}=1.8V, CCM$		2.1		MHz
$t_{ON\_MIN}$	Minimum on-time			80		ns
$t_{OFF\_MIN}$	Minimum off-time			100		ns
<b>Protection</b>						
$T_{SD}$	Thermal shutdown threshold			160		$^{\circ}C$
	Hysteresis			20		$^{\circ}C$

### TYPICAL CHARACTERISTICS

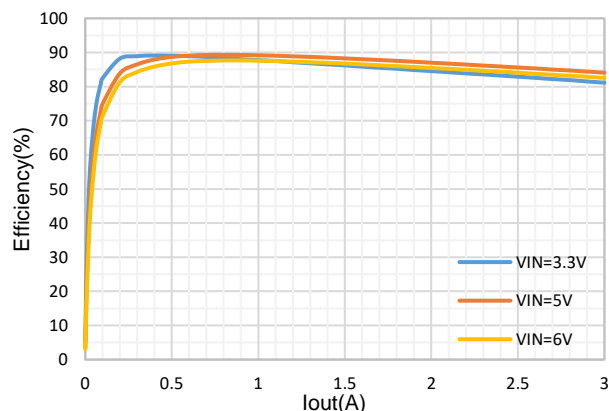

Figure 1. Efficiency vs Load Current, Vout=1.2V

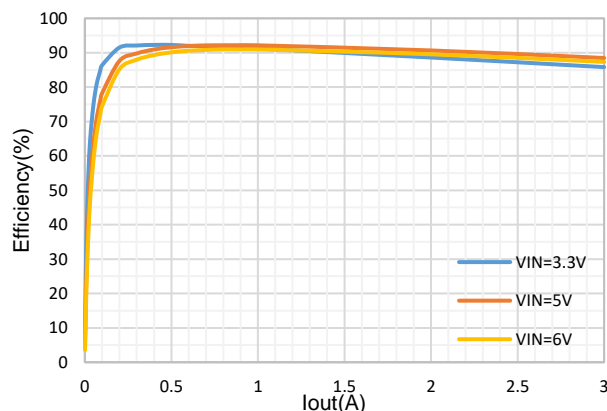

Figure 2. Efficiency vs Load Current, Vout=1.8V

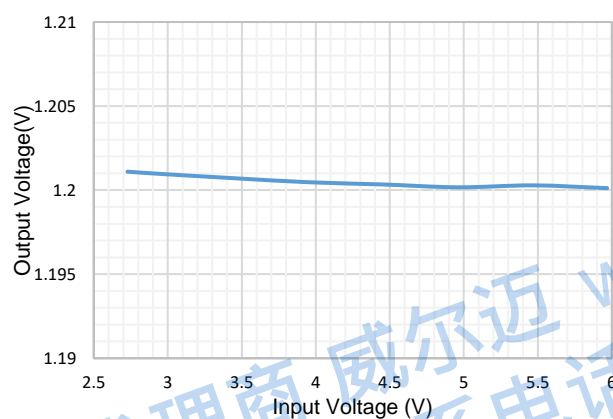

Figure 3. Line Regulation, Io=1.5A

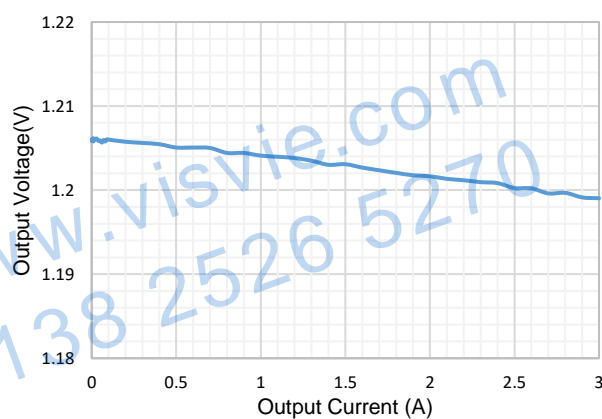

Figure 4. Load Regulation, Vin=5V

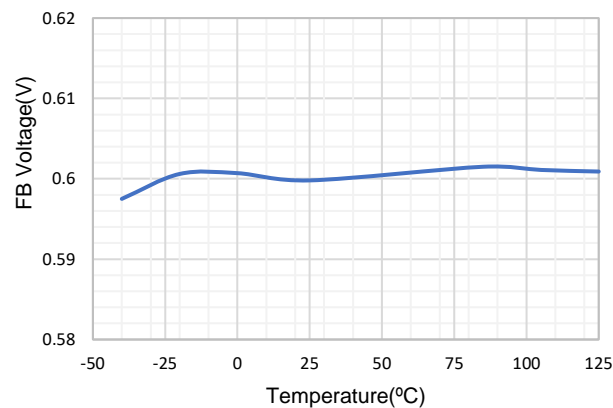

Figure 5. V<sub>FB</sub> vs Temperature

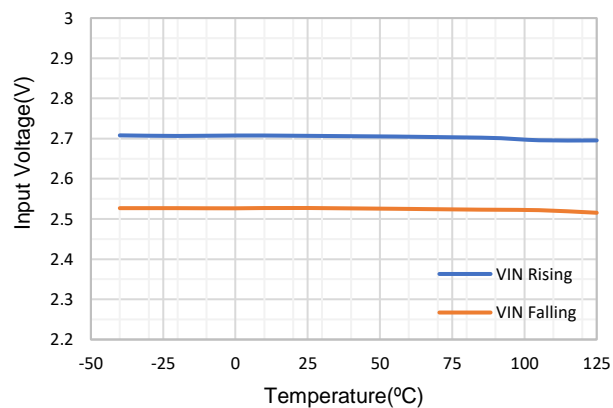

Figure 6. UVLO vs Temperature

## FUNCTIONAL BLOCK DIAGRAM

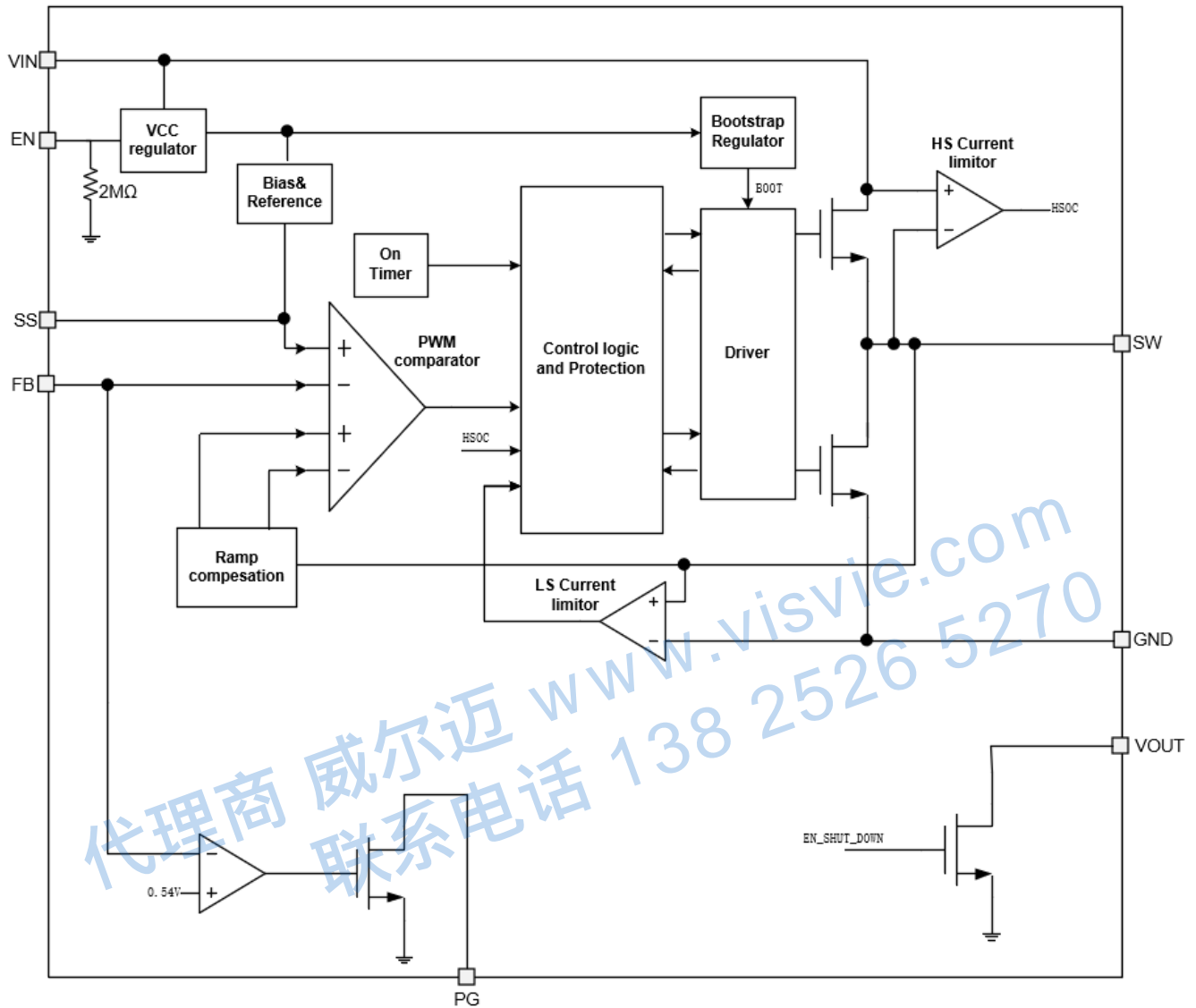

Figure 7. Functional Block Diagram

## OPERATION

### Overview

The SCT2130 is a 2.8V-6V input, 3A output, synchronous buck converter with built-in 25mΩ R<sub>dson</sub> high-side and 20mΩ R<sub>dson</sub> low-side power MOSFETs. It implements constant on time control to regulate output voltage, providing excellent line and load transient response, and internal error amplifier integrated improve the line and load regulation.

The switching frequency is fixed 2.1MHz. The SCT2130 features programmable soft start time to avoid large inrush current and output voltage overshoot during startup. The device also supports monolithic startup with pre-biased output condition. The SCT2130 operates in Forced Continuous Conduction Mode (FCCM) to achieve low light load ripple. The quiescent current is typically 1000uA under no load and no switching.

The SCT2130 full protection features include the input under-voltage lockout, over current protection with cycle-by-cycle current limiting and hiccup mode, output hard short protection and thermal shutdown protection.

### Constant On-time Control

Constant on-time (COT) control is employed to provide fast transient response and easy loop stabilization. At the beginning of each cycle, the high-side MOSFET is turned on for a fixed one shot time ON-time period. The one shot time is calculated by the converter's input voltage (V<sub>IN</sub>) and the output voltage (V<sub>OUT</sub>) cycle-by-cycle based to maintain a pseudo-fixed frequency over the input voltage range. SCT2130 turns off high-side MOSFET after the fixed-on time and turns on the low-side MOSFET. SCT2130 turns off the low-side MOSFET once the output voltage dropped below the output regulation, the one-shot timer then reset and the high-side MOSFET is turned on again. The on-time is inversely proportional to the input voltage and proportional to the output voltage. It can be calculated using the following Equation 1:

$$t_{ON} = \frac{V_{OUT}}{V_{IN} \times f_s} \quad (1)$$

Where:

- V<sub>OUT</sub> is the output voltage.
- V<sub>IN</sub> is the input voltage.
- f<sub>s</sub> is the switching frequency.

After an ON-time period, the regulator goes into the OFF-time period. The OFF-time period length depends on VFB in most cases. It will end when the FB voltage decreases below 0.6V, at which point the ON-time period is triggered. If the OFF-time period is less than the minimum OFF time, the minimum OFF time will be applied, which is around 100ns typical.

### Under Voltage Lockout UVLO

The SCT2130 Under Voltage Lock Out (UVLO) default startup threshold is typical 2.7V with V<sub>IN</sub> rising and shutdown threshold is 2.525V with V<sub>IN</sub> falling.

### Enable (EN) and VOUT discharge

EN is a digital control pin that can turn the regulator on and off. When EN is pulled below the falling threshold voltage (0.4V), the chip shuts down. Force EN above its rising threshold voltage (1.2V) to turn the part on. Leave EN floating or pull it down to ground to disable the SCT2130. There is an internal 2MΩ resistor connected from the EN pin to ground.

# SCT2130

When the device is disabled, the part automatically goes into output discharge mode, and its internal discharge MOSFET in VOUT pin provides a discharge path for the output capacitor.

## Output Voltage

The SCT2130 regulates the internal reference voltage at 0.6V. The output voltage is set by a resistor divider from the output node to the FB pin. It is recommended to use 1% tolerance or better resistors. Use Equation 2 to calculate resistance of resistor dividers. To improve efficiency at light loads, larger value resistors are recommended. However, if the values are too high, the regulator will be more susceptible to noise affecting output voltage accuracy.

$$R_{FB\_TOP} = \left( \frac{V_{OUT}}{V_{REF}} - 1 \right) * R_{FB\_BOT} \quad (2)$$

Where:

- $R_{FB\_TOP}$  is the resistor connecting the output to the FB pin.
- $R_{FB\_BOT}$  is the resistor connecting the FB pin to the ground.

## Soft Start (SS)

The SCT2130 has an external soft start (SS) pin that ramps up the output voltage at a controlled slew rate to avoid overshoot at startup. The SS pin's charge current is typically 3 $\mu$ A. The soft-start time (tss) is determined by the SS capacitor. tss can be calculated with Equation 3:

$$t_{ss}(mS) = \frac{C_{SS}(nF) * 0.6(V)}{I_{SS}(\mu A)} \quad (3)$$

Where:

- $C_{SS}$  is the external SS capacitor.
- $I_{SS}$  is the internal 3 $\mu$ A SS charge current.

The minimum SS capacitor is recommended to be 1nF.

## Over Current Protection (OCP) and Hiccup Mode

In each switching cycle, the inductor current is sensed by monitoring the high-side MOSFET during the ON period and the low-side MOSFET during the OFF period. When the inductor current (IL) reaches the high-side MOSFET peak current limit (typically 4.5A) during the ON period, the high-side MOSFET is forced off immediately to prevent the current from rising further. Then the low-side MOSFET turns on, and stays on until IL drops below the low-side MOSFET valley current limit (typically 3.5A). If output loading continues to increase, output will drop below the  $V_{UVP}$ , and SS pin is discharged such that output is 0V. Then the device will count for 7 cycles of soft-start time for hiccup waiting time and restart normally after 7 cycles' soft-start period. If overload or hard short condition still exists during soft-start and make FB voltage lower than  $V_{UVP}$ , the device enters into turning-off mode again. When overload or hard short condition is removed, the device automatically recovers to enters normal regulating operation.

## Power Good Indicator

The SCT2130 has one power good (PG) output to indicate normal operation after the soft-start time. PG is the open drain of an internal MOSFET, which has a maximum  $R_{DS(ON)}$  below 200 $\Omega$ . PG can be connected to VIN or an external voltage source through an external a resistor (e.g., 100k $\Omega$ ). After the input voltage is applied, the MOSFET turns on, and PG is pulled to GND before soft start is ready. After  $V_{FB}$  reaches 95% of  $V_{REF}$ , PG is pulled high by the external voltage source with 80 $\mu$ s delay. When  $V_{FB}$  drops to 90% or rises to 110% of  $V_{REF}$ , the PG voltage is



pulled to GND to indicate an output failure. If VIN and EN are not available, and PG is pulled up by an external power supply, PG will self-bias and assert. If a 100kΩ pull-up resistor is used, the voltage on the pin is below 0.4V.

### Thermal Shutdown

Once the junction temperature in the SCT2130 exceeds 160°C, the thermal sensing circuit stops converter switching and restarts with the junction temperature falling below 140°C. Thermal shutdown prevents the damage on device during excessive heat and power dissipation condition.

代理商 威尔迈 [www.visvie.com](http://www.visvie.com)  
联系电话 138 2526 5270

# SCT2130

## APPLICATION INFORMATION

### Typical Application

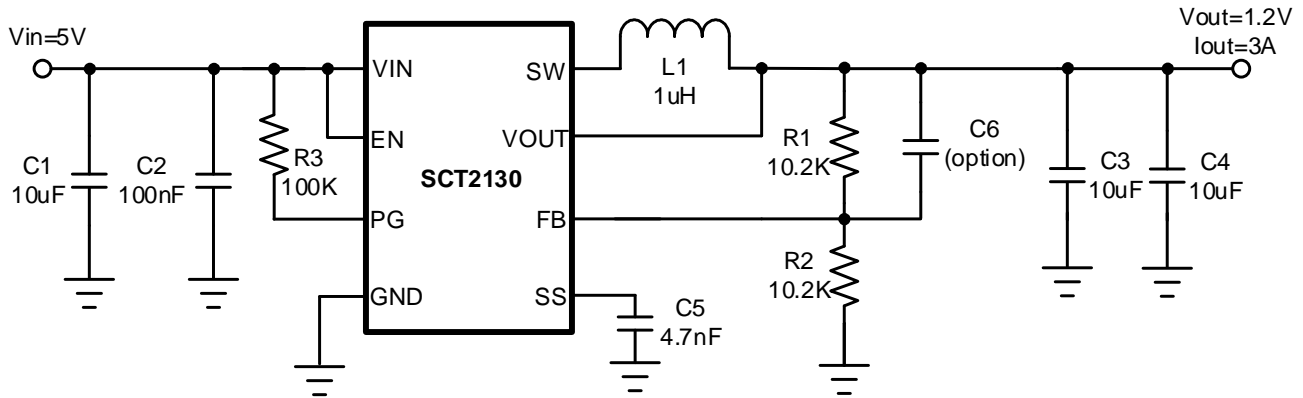

Figure 8. SCT2130 Design Example, 1.2V Output

#### Design Parameters

Design Parameters	Example Value
Input Voltage	5V Normal 2.8V to 6V
Output Voltage	1.2V
Maximum Output Current	3A
Switching Frequency	2.1MHz
Output voltage ripple (peak to peak)	2mV
Transient Response 0.3A to 2.7A load step	$\Delta V_{out} = 140mV$

## Output Voltage

The output voltage is set by an external resistor divider R1 and R2 in typical application schematic. Recommended R2 resistance is 10.2KΩ. Use Equation 4 to calculate R1.

$$R_1 = \left( \frac{V_{OUT}}{V_{REF}} - 1 \right) * R_2 \quad (4)$$

where:

- $V_{REF}$  is the feedback reference voltage, typical 0.6V

**Table 1. R1, R2 Value for Common Output Voltage (Room Temperature)**

$V_{OUT}$	$R_1$	$R_2$
1.2 V	10.2 KΩ	10.2 KΩ
1.8 V	20 KΩ	10.2 KΩ
3.3 V	46.5 KΩ	10.2 KΩ

## Inductor Selection

There are several factors should be considered in selecting inductor such as inductance, saturation current, the RMS current and DC resistance (DCR). Larger inductance results in less inductor current ripple and therefore leads to lower output voltage ripple. However, the larger value inductor always corresponds to a bigger physical size, higher series resistance, and lower saturation current. A good rule for determining the inductance to use is to allow the inductor peak-to-peak ripple current to be approximately 10%~40% of the maximum output current.

The peak-to-peak ripple current in the inductor  $I_{LPP}$  can be calculated as in Equation 5.

$$I_{LPP} = \frac{V_{OUT} * (V_{IN} - V_{OUT})}{V_{IN} * L * f_{SW}} \quad (5)$$

Where:

- $I_{LPP}$  is the inductor peak-to-peak current.
- $L$  is the inductance of inductor.
- $f_{SW}$  is the switching frequency.
- $V_{OUT}$  is the output voltage.
- $V_{IN}$  is the input voltage.

Since the inductor-current ripple increases with the input voltage, so the maximum input voltage in application is always used to calculate the minimum inductance required. Use Equation 6 to calculate the inductance value.

$$L_{MIN} = \frac{V_{OUT}}{f_{SW} * LIR * I_{OUT(max)}} * \left( 1 - \frac{V_{OUT}}{V_{IN(max)}} \right) \quad (6)$$

Where:

- $L_{MIN}$  is the minimum inductance required.
- $f_{sw}$  is the switching frequency.
- $V_{OUT}$  is the output voltage.
- $V_{IN(max)}$  is the maximum input voltage.
- $I_{OUT(max)}$  is the maximum DC load current.
- $LIR$  is coefficient of  $I_{LPP}$  to  $I_{OUT}$ .

The total current flowing through the inductor is the inductor ripple current plus the output current. When selecting an inductor, choose its rated current especially the saturation current larger than its peak operation current and RMS current also not be exceeded. Therefore, the peak switching current of inductor,  $I_{LPEAK}$  and  $I_{LRMS}$  can be calculated as in Equation 7 and Equation 8.

$$I_{LPEAK} = I_{OUT} + \frac{I_{LPP}}{2} \quad (7)$$

$$I_{LRMS} = \sqrt{(I_{OUT})^2 + \frac{1}{12} * (I_{LPP})^2} \quad (8)$$

Where:

- $I_{LPEAK}$  is the inductor peak current.
- $I_{OUT}$  is the DC load current.
- $I_{LPP}$  is the inductor peak-to-peak current.
- $I_{LRMS}$  is the inductor RMS current.

In overloading or load transient conditions, the inductor peak current can increase up to the switch current limit of the device which is typically 4.5A. The most conservative approach is to choose an inductor with a saturation current rating greater than 4.5A. Because of the maximum  $I_{LPEAK}$  limited by device, the maximum output current that the SCT2130 can deliver also depends on the inductor current ripple. Thus, the maximum desired output current also affects the selection of inductance. The smaller inductor results in larger inductor current ripple leading to a lower maximum output current.

## Input Capacitor Selection

The input current to the step-down DCDC converter is discontinuous, therefore it requires a capacitor to supply the AC current to the step-down DCDC converter while maintaining the DC input voltage. Use capacitors with low ESR for better performance. Ceramic capacitors with X5R or X7R dielectrics are usually suggested because of their low ESR and small temperature coefficients, and it is strongly recommended to use another lower value capacitor (e.g. 0.1uF) with small package size (0603) to filter high frequency switching noise. Place the small size capacitor as close to VIN and GND pins as possible.

The voltage rating of the input capacitor must be greater than the maximum input voltage. And the capacitor must also have a ripple current rating greater than the maximum input current ripple. The RMS current in the input capacitor can be calculated using Equation 9.

$$I_{CINRMS} = I_{OUT} * \sqrt{\frac{V_{OUT}}{V_{IN}} * (1 - \frac{V_{OUT}}{V_{IN}})} \quad (9)$$

The worst case condition occurs at  $V_{IN}=2*V_{OUT}$ , where:

$$I_{CINRMS} = 0.5 * I_{OUT} \quad (10)$$

For simplification, choose an input capacitor with an RMS current rating greater than half of the maximum load current.

When selecting ceramic capacitors, it needs to consider the effective value of a capacitor decreasing as the DC bias voltage across a capacitor increasing.

The input capacitance value determines the input ripple voltage of the regulator. The input voltage ripple can be calculated using Equation 11 and the maximum input voltage ripple occurs at 50% duty cycle.

$$\Delta V_{IN} = \frac{I_{OUT}}{f_{SW} * C_{IN}} * \frac{V_{OUT}}{V_{IN}} * (1 - \frac{V_{OUT}}{V_{IN}}) \quad (11)$$

For this example, 10μF, X7R ceramic capacitors rated for 16 V in parallel are used. And a 0.1 μF for high-frequency filtering capacitor is placed as close as possible to the device pins.

## Output Capacitor Selection

The selection of output capacitor will affect output voltage ripple in steady state and load transient performance.

The output ripple is essentially composed of two parts. One is caused by the inductor current ripple going through the Equivalent Series Resistance ESR of the output capacitors and the other is caused by the inductor current ripple charging and discharging the output capacitors. To achieve small output voltage ripple, choose a low-ESR output capacitor like ceramic capacitor. For ceramic capacitors, the capacitance dominates the output ripple. For simplification, the output voltage ripple can be estimated by Equation 12 desired.

$$\Delta V_{OUT} = \frac{V_{OUT} * (V_{IN} - V_{OUT})}{8 * f_{SW}^2 * L * C_{OUT} * V_{IN}} \quad (12)$$

Where:

- $\Delta V_{OUT}$  is the output voltage ripple.
- $f_{SW}$  is the switching frequency.
- L is the inductance of inductor.
- $C_{OUT}$  is the output capacitance.
- $V_{OUT}$  is the output voltage.
- $V_{IN}$  is the input voltage.

Due to capacitor's degrading under DC bias, the bias voltage can significantly reduce capacitance. Ceramic capacitors can lose most of their capacitance at rated voltage. Therefore, leave margin on the voltage rating to ensure adequate effective capacitance. Typically, two 10 $\mu$ F ceramic output capacitors work for most applications.

Table 2: Component List with Typical Output Voltage BOM list

Vout	L1	COUT	R1	R2	C6
1.2V	1 $\mu$ H	20 $\mu$ F	10.2K	10.2K	option
1.8V	1 $\mu$ H	20 $\mu$ F	20K	10.2K	option

## Application Waveforms

$V_{IN}=5V$ ,  $V_{OUT}=1.2V$ , unless otherwise noted

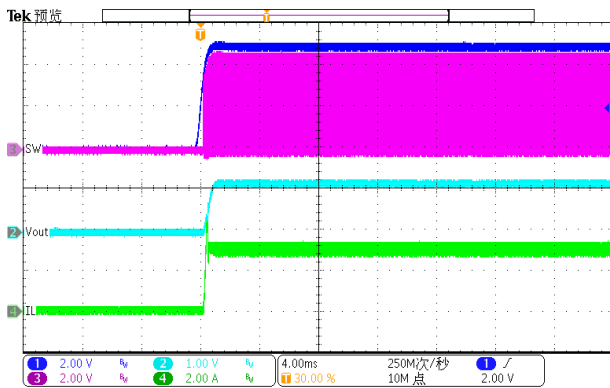

Figure 9. Power up ( $I_{LOAD}=3A$ )

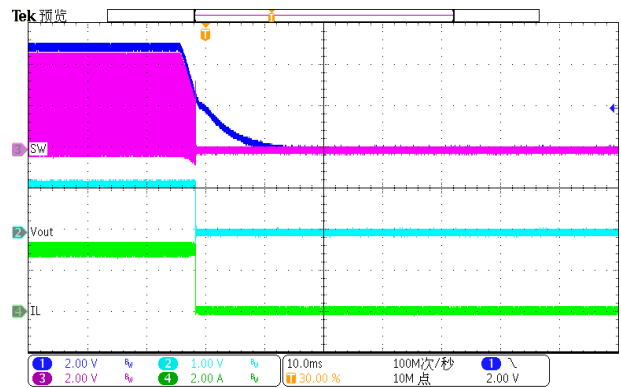

Figure 10. Power down ( $I_{LOAD}=3A$ )

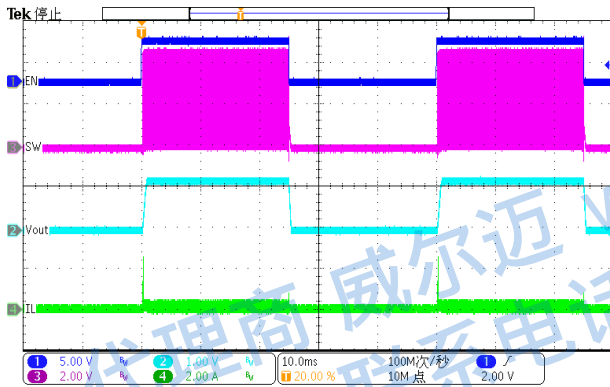

Figure 11. EN toggle ( $I_{LOAD}=0.1A$ )

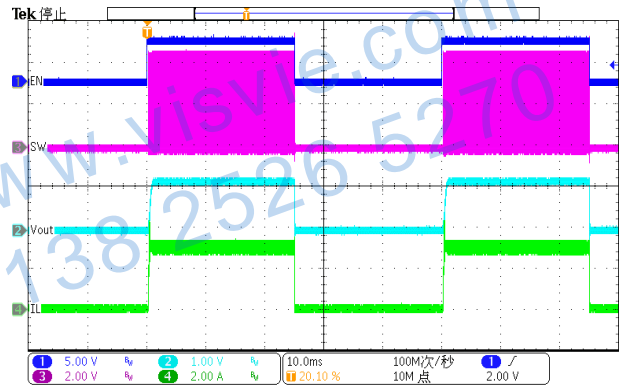

Figure 12. EN toggle ( $I_{LOAD}=3A$ )

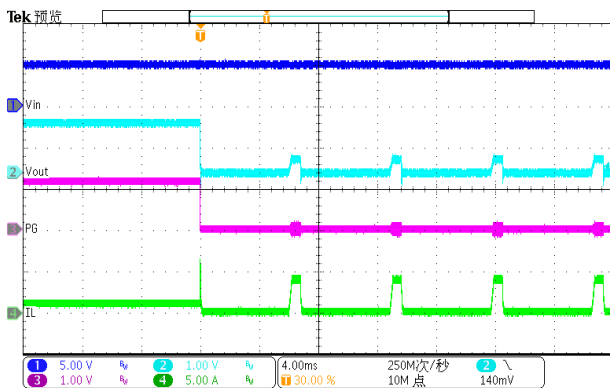

Figure 13. Over Current Protection (1A to hard short)

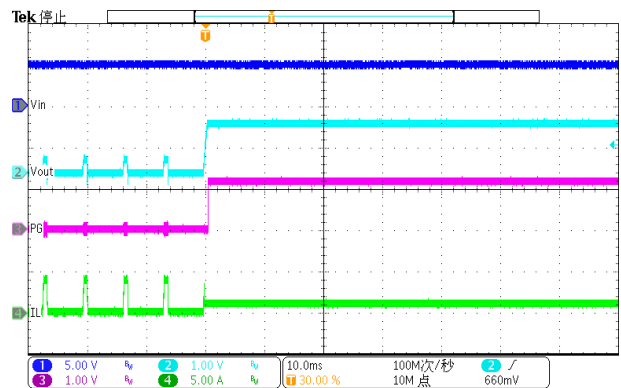

Figure 14. Over Current Release (hard short to 1A)

Application Waveforms

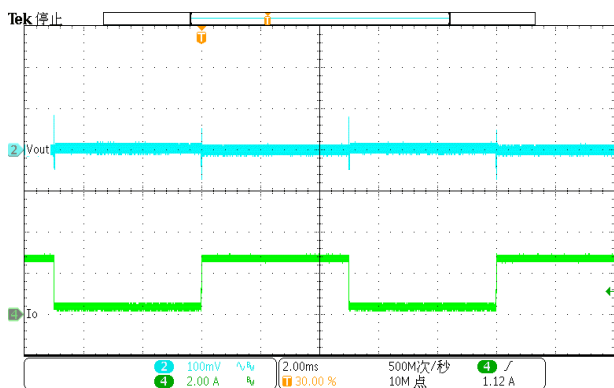

Figure 15. Load Transient (0.3A-2.7A, 1.6A/us)

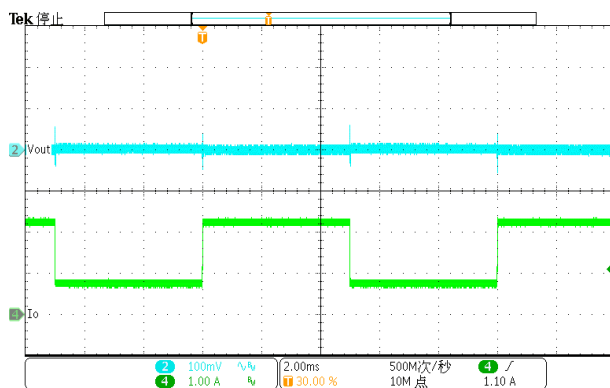

Figure 16. Load Transient (0.75A-2.25A, 1.6A/us)

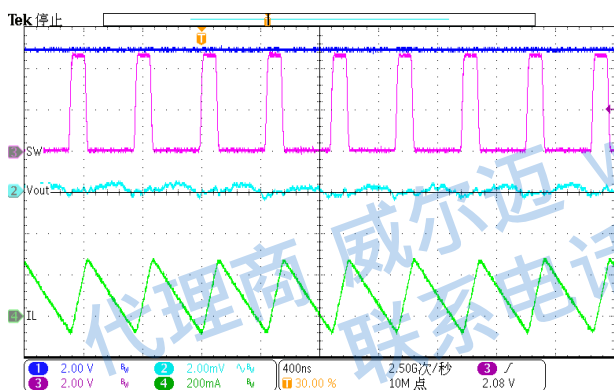

Figure 17. Output Ripple (I<sub>LOAD</sub>=100mA)

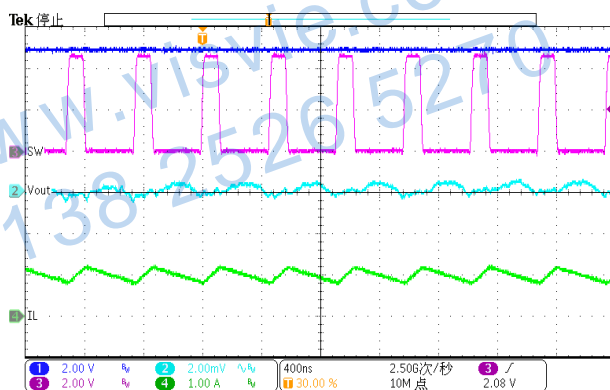

Figure 18. Output Ripple (I<sub>LOAD</sub>=1A)

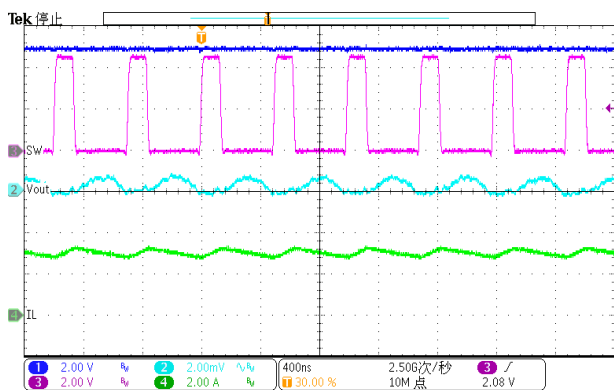

Figure 19. Output Ripple (I<sub>LOAD</sub>=3A)



Figure 20. Thermal, V<sub>IN</sub>=5V, V<sub>OUT</sub>=1.2V, I<sub>LOAD</sub>=3A

# SCT2130

## Layout Guideline

Proper PCB layout is a critical for SCT2130's stable and efficient operation. The traces conducting fast switching currents or voltages are easy to interact with stray inductance and parasitic capacitance to generate noise and degrade performance. For better results, follow these guidelines as below:

1. Power grounding scheme is very critical because of carrying power, thermal, and glitch/bouncing noise associated with clock frequency. The thumb of rule is to make ground trace lowest impedance and power are distributed evenly on PCB. Sufficiently placing ground area will optimize thermal and not causing over heat area.
2. Place a low ESR ceramic capacitor as close to VIN pin and the ground as possible to reduce parasitic effect.
3. For operation at full rated load, the top side ground area must provide adequate heat dissipating area. Make sure top switching loop with power have lower impedance of grounding.
4. The bottom layer is a large ground plane connected to the ground plane on top layer by vias. The power pad should be connected to bottom PCB ground planes using multiple vias directly under the IC. The center thermal pad should always be soldered to the board for mechanical strength and reliability, using multiple thermal vias underneath the thermal pad. Improper soldering thermal pad to ground plate on PCB will cause SW higher ringing and overshoot besides downgrading thermal performance. It is recommended 8mil diameter drill holes of thermal vias, but a smaller via offers less risk of solder volume loss. On applications where solder volume loss thru the vias is of concern, plugging or tenting can be used to achieve a repeatable process.
5. Output inductor should be placed close to the SW pin. The area of the PCB conductor minimized to prevent excessive capacitive coupling.
6. Route BST capacitor trace on the bottom layer to provide wide path for topside ground.

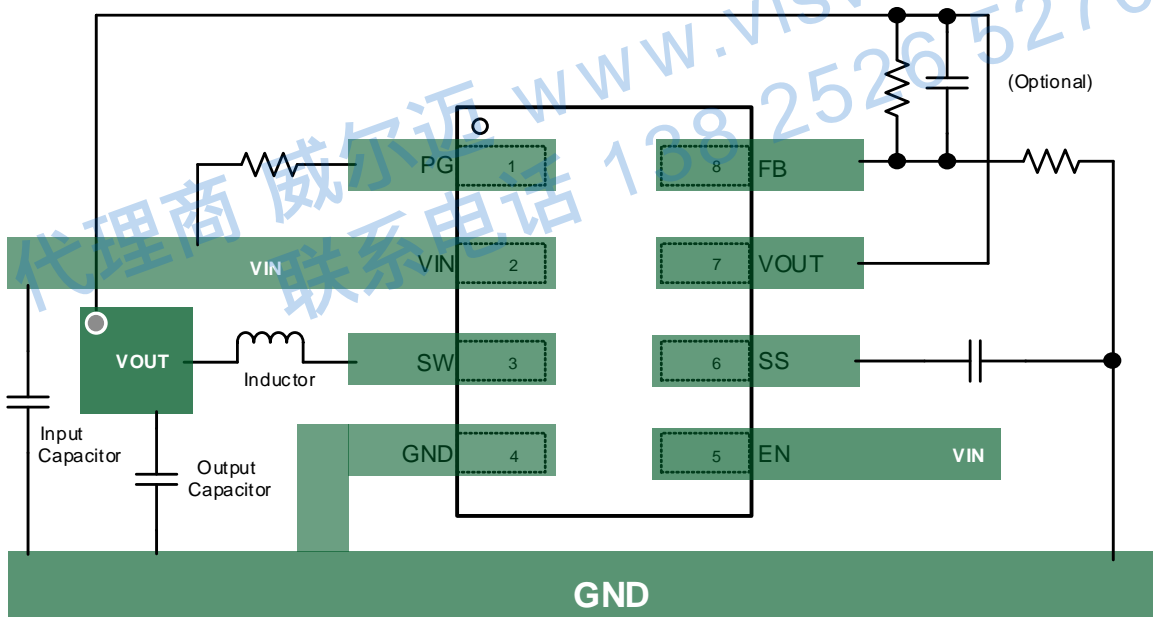
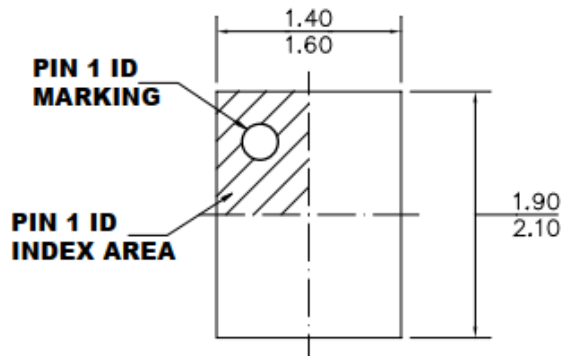

Figure 21. PCB Layout Example



PACKAGE INFORMATION



TOP VIEW

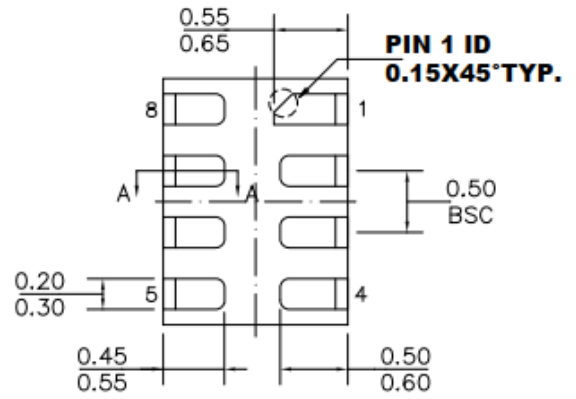

BOTTOM VIEW

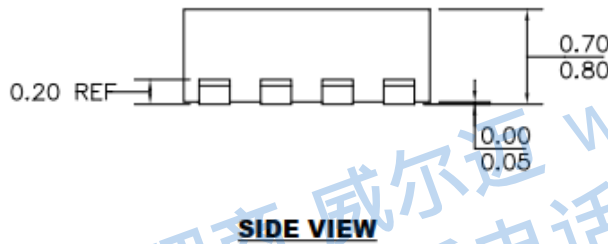

SIDE VIEW

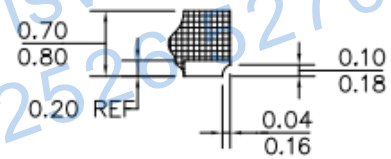

SECTION A-A

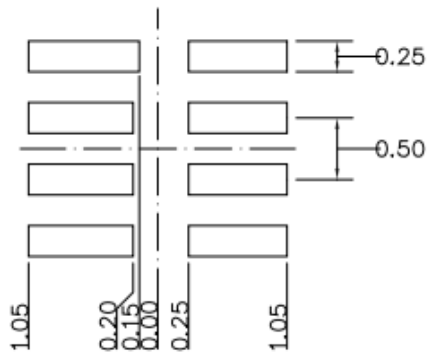

RECOMMENDED LAND PATTERN

**NOTE:**

- 1) THE LEAD SIDE IS WETTABLE.
- 2) ALL DIMENSIONS ARE IN MILLIMETERS.
- 3) LEAD COPLANARITY SHALL BE 0.08 MILLIMETERS MAX.
- 4) JEDEC REFERENCE IS MO-220.
- 5) DRAWING IS NOT TO SCALE.

# SCT2130

## TAPE AND REEL INFORMATION

Orderable Device	Package Type	Pins	SPQ
SCT2130FTAR	QFN 1.5mmx2mm	8	3000

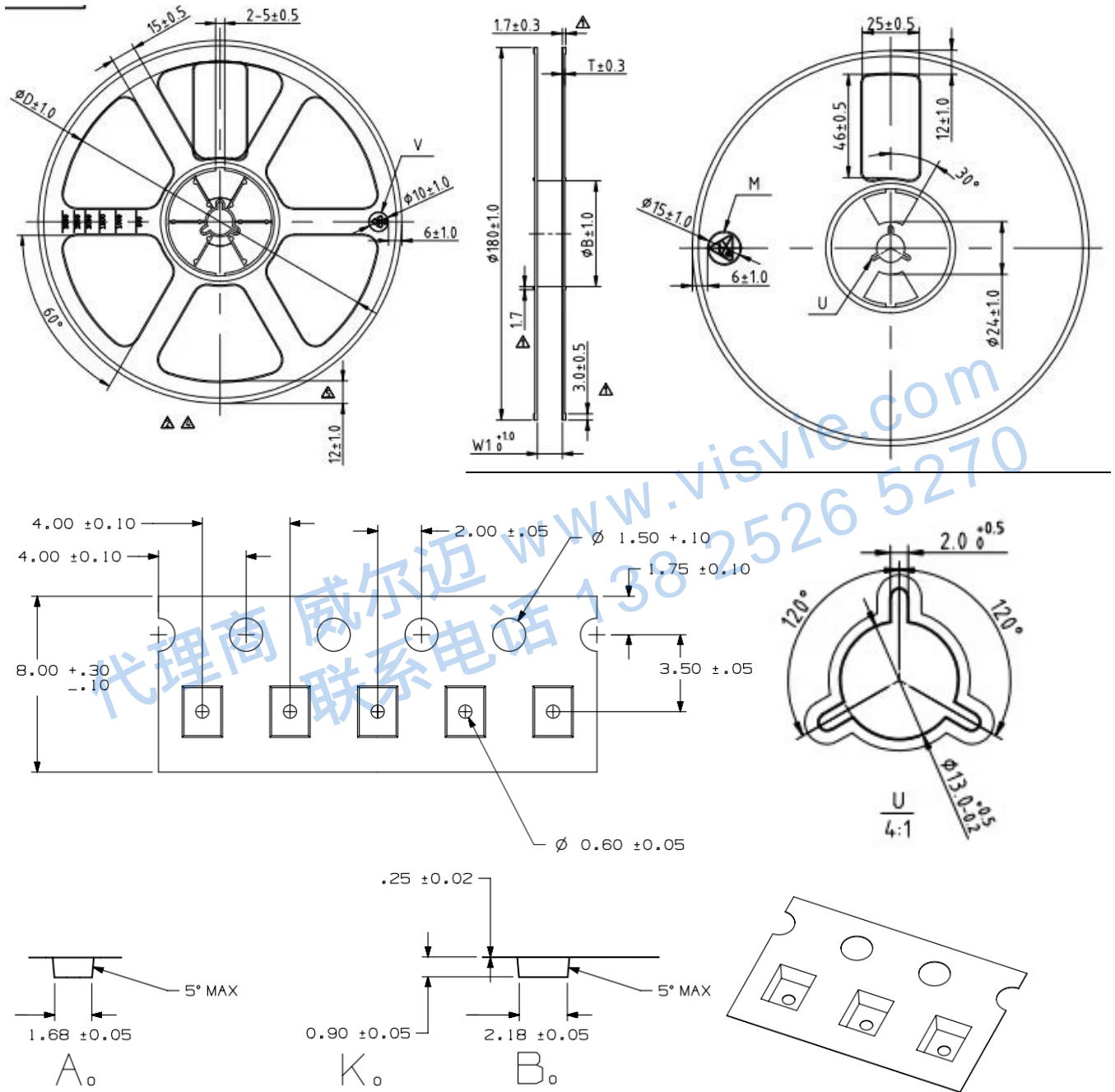

**NOTICE:** The information in this document is subject to change without notice. Users should warrant and guarantee the third party Intellectual Property rights are not infringed upon when integrating Silicon Content Technology (SCT) products into any application. SCT will not assume any legal responsibility for any said applications.