

Ideal Diode Controller with Reverse-Current Protection

FEATURES

- 4V to 65V Operating Range
- -65V Reverse voltage rating
- Charge pump for external N-Channel MOSFET
- 20mV ANODE to CATHODE forward voltage drop regulation
- 12V Gate Drive Voltage
- With Enable Input
- Drive High Side External N-Channel MOSFET
- 1 μ A Shutdown current (EN=Low)
- 80 μ A Operating quiescent current (EN=High)
- 2.3-A Peak gate turnoff current
- Fast reverse current turn-off within 0.75 μ s
- Meets automotive ISO7637 transient requirements with a suitable TVS Diode
- Available in an TSOT23-6L Package

APPLICATIONS

- Automotive Battery Protection
- Redundant Power Supplies
- Industrial Factory Automation
- Enterprise Power Supplies
- Network Telecom Power Systems
- Servers

DESCRIPTION

The SCT53600 is an ideal diode controller which paired with an external N-channel MOSFET as an ideal diode rectifier for low loss reverse polarity protection to replace a Schottky Diode. The SCT53600 operates over a wide supply voltage range of 4V to 65V. The device can withstand and protect the load against damaging from negative supply voltages down to -65V and blocks reverse current flow helping to simplify the system designs for automotive ISO7637 protection.

The SCT53600 controller provides a charge pump gate drive for an external N-channel MOSFET. The device regulates the forward voltage drop across the external MOSFET to 20mV allowing smooth, ring-free operation with providing very fast turn-off (< 0.75 μ s) of the MOSFET during a reverse event to minimize reverse current if power source fails or input micro-short conditions. The fast response to Reverse Current Blocking makes the device suitable for systems with output voltage holdup requirements during ISO7637 pulse testing.

The SCT53600 consumes only 1 μ A of current during shutdown mode with the enable pin low to extend battery life. The device is available in an TSOT23-6 package.

TYPICAL APPLICATION

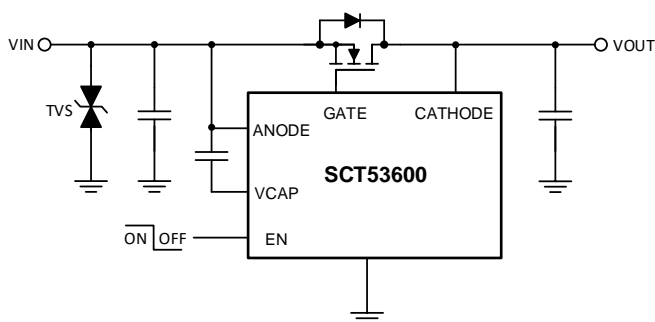

Typical Application

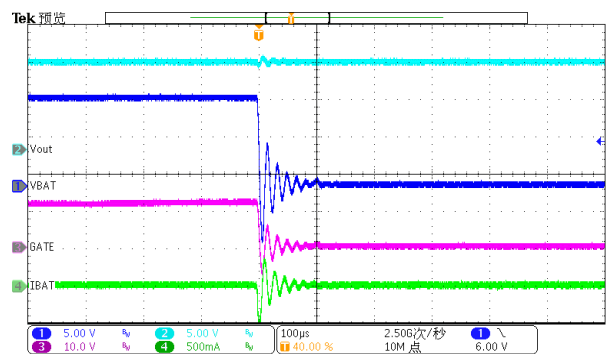

Reverse Current Blocking

SCT53600

REVISION HISTORY

NOTE: Page numbers for previous revisions may differ from page numbers in the current version.

Revision 0.6: Customer Preview

DEVICE ORDER INFORMATION

PART NUMBER	PACKAGE MARKING	PACKAGE DISCRIPTION
SCT53600TVB	3600	TSOT23-6L

1) For Tape & Reel, Add Suffix R (e.g. SCT53600TVBR)

ABSOLUTE MAXIMUM RATINGS

Over operating free-air temperature unless otherwise noted⁽¹⁾

DESCRIPTION	MIN	MAX	UNIT
ANODE to GND	-65	65	V
EN to GND, $V_{(ANODE)} > 0$ V	-0.3	72	V
EN to GND, $V_{(ANODE)} \leq 0$ V	$V_{(ANODE)}$	$65 + V_{(ANODE)}$	V
GATE to ANODE	-0.3	15	V
VCAP to ANODE	-0.3	15	V
CATHODE to ANODE	-5	75	V
Operating junction temperature $T_J^{(2)}$	-40	150	°C
Storage temperature T_{STG}	-65	150	°C

PIN CONFIGURATION

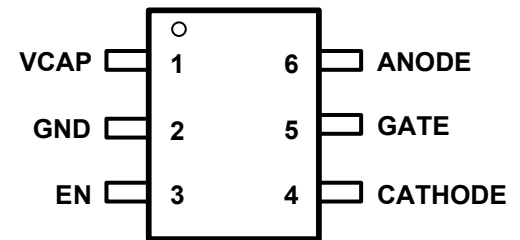

Figure 1. 6-Lead Plastic TSOT23-6L

- (1) Stresses beyond those listed under Absolute Maximum Rating may cause device permanent damage. The device is not guaranteed to function outside of its Recommended Operation Conditions.
- (2) The IC includes over temperature protection to protect the device during overload conditions. Junction temperature will exceed 150°C when over temperature protection is active. Continuous operation above the specified maximum operating junction temperature will reduce lifetime.

PIN FUNCTIONS

NAME	NO.	PIN FUNCTION
VCAP	1	Charge pump output. Connect a charge pump capacitor typically 0.1uF between VCAP and ANODE.
GND	2	Ground.
EN	3	Enable pin. Drive EN low to make the device in shutdown mode. Can be connected to ANODE for always ON operation.
CATHODE	4	Cathode of the diode. Connect to the drain of the external N-channel MOSFET.
GATE	5	Gate drive output. Connect to the gate of the external n-channel MOSFET. GATE shorts to ANODE during reverse-current conditions and when EN is forced low.
ANODE	6	Anode of the diode and input power. Connect to the source of the external N-channel MOSFET.

RECOMMENDED OPERATING CONDITIONS

Over operating free-air temperature range unless otherwise noted

PARAMETER	DEFINITION	MIN	MAX	UNIT
$V_{(ANODE)}$	ANODE to GND	-60	60	V
$V_{(CATHODE)}$	CATHODE to GND		60	V
V_{EN}	EN to GND	-60	60	V
$V_{(ANODE)} - V_{(CATHODE)}$	ANODE to CATHODE	-70		V
T_J	Operating junction temperature	-40	150	°C

ESD RATINGS

PARAMETER	DEFINITION	MIN	MAX	UNIT
V_{ESD}	Human Body Model(HBM), per ANSI-JEDEC-JS-001-2014 specification, all pins ⁽¹⁾	TBD	TBD	kV
	Charged Device Model(CDM), per ANSI-JEDEC-JS-002-2014 specification, all pins ⁽²⁾	-0.5	+0.5	kV

(1) JEDEC document JEP155 states that 500V HBM allows safe manufacturing with a standard ESD control process.

(2) JEDEC document JEP157 states that 250V CDM allows safe manufacturing with a standard ESD control process.

THERMAL INFORMATION

PARAMETER	THERMAL METRIC	TSOT23-6L	UNIT
θ_{ja}	Junction-to-ambient thermal resistance (standard board)	102	°C/W
θ_{jctop}	Junction-to-case (top) thermal resistance	36.9	

(1) SCT provides $R_{\theta JA}$ and $R_{\theta JC}$ numbers only as reference to estimate junction temperatures of the devices. $R_{\theta JA}$ and $R_{\theta JC}$ are not a characteristic of package itself, but of many other system level characteristics such as the design and layout of the printed circuit board (PCB) on which the SCT2601 is mounted, thermal pad size, and external environmental factors. The PCB board is a heat sink that is soldered to the leads and thermal pad of the SCT2600. Changing the design or configuration of the PCB board changes the efficiency of the heat sink and therefore the actual $R_{\theta JA}$ and $R_{\theta JC}$.

ELECTRICAL CHARACTERISTICS $T_J = -40^{\circ}\text{C} \sim 125^{\circ}\text{C}$, typical value is tested under 25°C .

SYMBOL	PARAMETER	TEST CONDITION	MIN	TYP	MAX	UNIT
SUPPLY VOLTAGE						
$V_{(ANODE)}$	Operating input voltage		4		60	V
$V_{(ANODE\ POR)}$	VANODE POR Rising threshold			3.6		V
	VANODE POR Falling threshold			3		V
I_{SHDN}	Shutdown current	$V_{EN} = 0V$		0.9	1.5	μA
I_Q	Quiescent current			80	130	μA
ENABLE						
V_{EN_H}	Enable input high threshold			2		V
V_{EN_L}	Enable input low threshold			0.8		V
V_{EN_HYS}	Enable Hysteresis			1.2		V
I_{EN}	Enable sink current	$V_{EN} = 12V$		3		μA
V_{ANODE} to $V_{CATHODE}$						
V_{AC_REG}	Regulated Forward Threshold			20		mV

SCT53600

SYMBOL	PARAMETER	TEST CONDITION	MIN	TYP	MAX	UNIT
V_{AC}	threshold for full conduction mode			50		mV
V_{AC_REV}	threshold for reverse current blocking			-11		mV
Gm	Regulation Error AMP Transconductance			1800		$\mu A/V$

GATE DRIVE

I_{GATE}	Peak source current	$V_{ANODE} - V_{CATHODE} = 100\text{ mV}$, $V_{GATE} - V_{ANODE} = 5\text{ V}$		7		mA
	Peak sink current	$V_{ANODE} - V_{CATHODE} = -20\text{ mV}$, $V_{GATE} - V_{ANODE} = 5\text{ V}$		2370		mA
	Regulation max sink current	$V_{ANODE} - V_{CATHODE} = 0\text{ V}$, $V_{GATE} - V_{ANODE} = 5\text{ V}$		17		μA
R_{DSON}	discharge switch R_{DSON}	$V_{ANODE} - V_{CATHODE} = -20\text{ mV}$, $V_{GATE} - V_{ANODE} = 100\text{ mV}$		0.8		Ω

CHARGE PUMP

I_{VCAP}	Charge Pump source current (Charge pump on)	$V_{VCAP} - V_{ANODE} = 7\text{ V}$		230		μA
	Charge Pump sink current (Charge pump off)	$V_{VCAP} - V_{ANODE} = 14\text{ V}$		5		μA
$V_{VCAP} - V_{ANODE}$	Charge pump voltage at $V_{ANODE} = 4\text{ V}$	$I_{VCAP} \leq 30\ \mu A$	8			V
	Charge pump turn on voltage			11.8		V
	Charge pump turn off voltage			13		V
	Charge Pump Enable comparator Hysteresis			0.9		V
V_{VCAP_UVLO}	$V_{VCAP} - V_{ANODE}$ UV release at rising edge	$V_{ANODE} - V_{CATHODE} = 100\text{ mV}$		6.95		V
	$V_{VCAP} - V_{ANODE}$ UV threshold at falling edge	$V_{ANODE} - V_{CATHODE} = 100\text{ mV}$		5.79		V

CATHODE

$I_{CATHODE}$	CATHODE sink current	$V_{ANODE} = 12\text{ V}$, $V_{ANODE} - V_{CATHODE} = -100\text{ mV}$		1.7		μA
		$V_{ANODE} - V_{CATHODE} = -100\text{ mV}$		1.2		μA
		$V_{ANODE} = -12\text{ V}$, $V_{CATHODE} = 12\text{ V}$		1.25		μA

Timing parameter

t_{EN_TDLY}	Enable (low to high) to Gate Turn On delay	$V_{VCAP} > V_{VCAP_UVLOR}$		200		μs
$t_{Reverse\ delay}$	Reverse voltage detection to Gate Turn Off delay	$V_{ANODE} - V_{CATHODE} = 100\text{ mV}$ to -100 mV		0.45		μs
$t_{Forward\ recovery}$	Forward voltage detection to Gate Turn On delay	$V_{ANODE} - V_{CATHODE} = -100\text{ mV}$ to 700 mV		1.23		μs

FUNCTIONAL BLOCK DIAGRAM

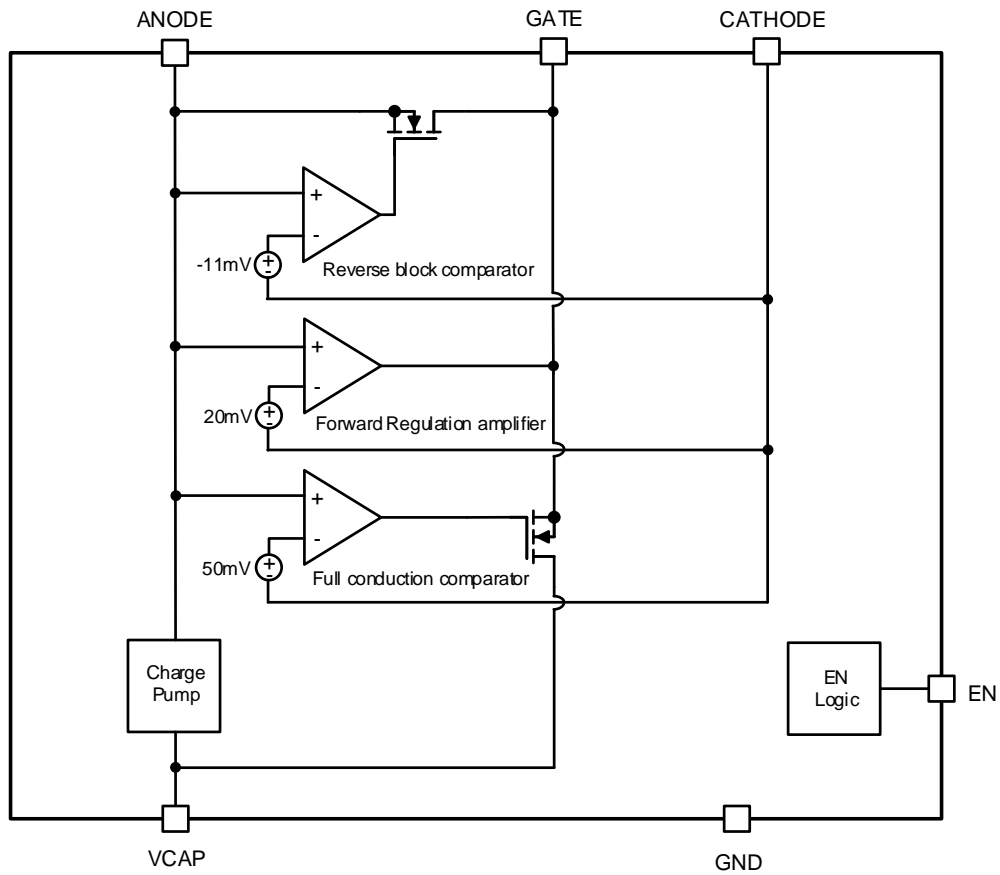

Figure 2. Functional Block Diagram

SCT53600

OPERATION

Overview

The SCT53600 is a high-voltage, ideal diode controller that provides system protection against reverse voltage, reverse-current flow, and destructive automotive transient voltages to implement an efficient and fast reverse polarity protection circuit or be used in a redundant power system. This easy to use ideal diode controller operates in conjunction with an external N-channel MOSFET to replace other reverse polarity schemes such as a P-channel MOSFET or a Schottky diode.

The SCT53600 controller provides a charge pump gate drive for an external N-channel MOSFET. The voltage drop across the MOSFET is continuously monitored between the ANODE and CATHODE pins, and the GATE to ANODE voltage is adjusted as needed to regulate the forward voltage drop at 20 mV. This closed loop regulation scheme enables graceful turn off of the MOSFET during a reverse current event and ensures zero DC reverse current flow. A fast reverse current condition is detected when the voltage across ANODE and CATHODE pins reduces below –11 mV, resulting in the GATE pin being internally connected to the ANODE pin turning off the external N-channel MOSFET, and using the body diode to block any of the reverse current. The fast response to Reverse Current Blocking makes the device suitable for systems with output voltage holdup requirements during ISO7637 pulse testing.

The SCT53600 consumes only 1 μ A of current during shutdown mode with the enable pin low to extend battery life. The device is available in an TSOT23-6 package.

Input Voltage

The ANODE pin is the power supply input for internal circuitry, typically drawing 80 μ A when enabled and 1 μ A when disabled. The SCT53600 operates if the ANODE pin voltage is greater than the POR Rising threshold with EN pin above the specified input high threshold V_{EN_H} . The voltage from ANODE to GND is designed to vary from 65 V to –65 V, allowing the SCT53600 to withstand negative voltage transients.

Enable

A logic input EN pin allows for the gate driver to be either enabled or disabled by an external signal. The EN pin can withstand a voltage as large as 65 V and as low at –65 V. This allows for the EN pin to be connected directly to the ANODE pin if enable functionality is not needed. EN has an internal 3 μ A sink current which means EN pin cannot be left floating for normal operation.

The SCT53600 enters shutdown mode when the EN pin voltage is below the specified input low threshold V_{EN_L} . Both the gate driver and the charge pump are disabled in shutdown mode. During shutdown mode the SCT53600 enters low IQ operation with the ANODE pin only sinking 1 μ A. When the SCT53600 is in shutdown mode, forward current flow through the external MOSFET is not interrupted but is conducted through the MOSFET's body diode.

Charge Pump

The SCT53600 uses a charge pump to generate the gate drive with respect to ANODE voltage. The charge pump supplies the voltage necessary to drive the external N-channel MOSFET. An external charge pump capacitor is placed between VCAP and ANODE pins to provide energy to turn on the external MOSFET.

The charge pump starts working and sources a charging current of 300 μ A typical if EN pin voltage exceeds 2V. If EN pins is pulled low, then the charge pump remains disabled. To ensure that the external MOSFET can be driven above its specified threshold voltage, the VCAP to ANODE voltage has the under voltage lockout threshold at typically 6.6 V.

Gate Driver and Conduction Mode

The gate driver is used to control the external N-Channel MOSFET. There are three defined modes of operation that the gate driver operates under forward regulation, full conduction mode and reverse current protection, according to the ANODE to CATHODE voltage.

The SCT53600 operate in **full conduction mode** if the current from source to drain of the external MOSFET be large enough to result in an ANODE to CATHODE voltage drop of greater than 50 mV typical. The GATE pin is internally connected to the VCAP pin resulting in the GATE to ANODE voltage being approximately the same as the VCAP to ANODE voltage. By connecting VCAP to GATE the external MOSFET's RDS(ON) is minimized reducing the power loss of the external MOSFET when forward currents are large.

The SCT53600 operate in **reverse current protection mode** if the ANODE to CATHODE voltage is typically less than –11 mv. The GATE pin is internally connected to the ANODE pin. The connection of the GATE to ANODE pin disables the external MOSFET. The body diode of the MOSFET blocks any reverse current from flowing from the drain to source.

The SCT53600 operate in **forward regulation mode** if the current from source to drain of the external MOSFET be within the range to result in an ANODE to CATHODE voltage drop of –11 mV to 50 mV. During forward regulation mode the ANODE to CATHODE voltage is regulated to 20 mV by adjusting the GATE to ANODE voltage. This closed loop regulation scheme enables graceful turn off of the MOSFET at very light loads and ensures zero DC reverse current flow.

SCT53600

APPLICATION INFORMATION

Typical Application- Reverse Polarity Protection

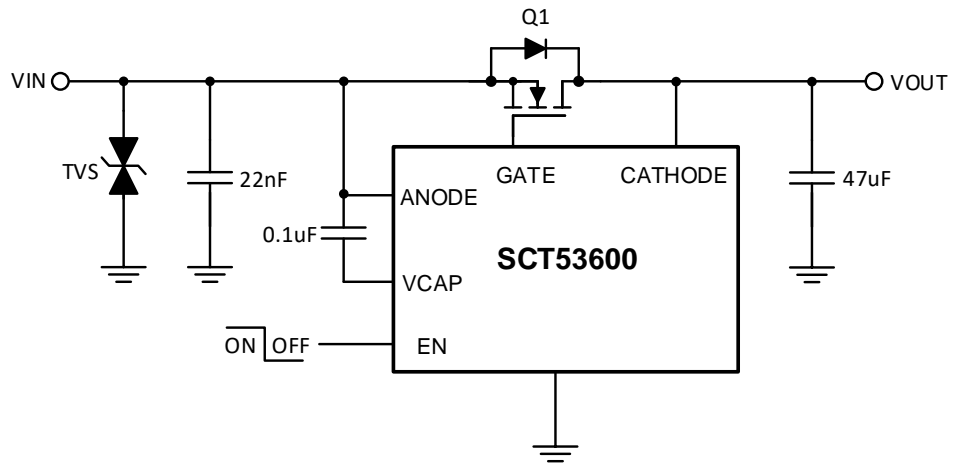

Figure 3. Typical 12V Battery Protection with single bi-directional TVS

Design Parameters

Design Parameters	Example Value
Input Voltage	12V Battery, 12V Nominal with 35V Load Dump
Output Voltage	4V during Cold Crank to 35V Load Dump
Output Current Range	3A Nominal, 5A Maximum
Output Capacitance	1 μ F Minimum, 47 μ F Typical Hold Up Capacitance

MOSFET Selection

MOSFET selection is critical to designing a proper protection circuit. Several factors must be considered: gate capacitance, maximum continuous drain current I_D , maximum drain-to-source voltage rating, on-resistance $R_{DS(ON)}$, maximum source current through body diode, peak power dissipation capability and the average power dissipation limit. Gate capacitance is not as critical, but it does determine the length of turn-on and turn-off times. MOSFETs with more gate capacitance tend to respond more slowly.

The maximum continuous drain current, I_D , rating must exceed the maximum continuous load current. The maximum drain-to-source voltage, $V_{DS(MAX)}$, must be high enough to withstand the highest differential voltage seen in the application. It is recommended to use MOSFETs with voltage rating up to 60 V maximum with the SCT53600 because anode-cathode maximum voltage is 65V. The maximum V_{GS} SCT53600 can drive is 13-V, so a MOSFET with 15-V minimum V_{GS} should be selected. If a MOSFET with <15-V V_{GS} rating is selected, a zener diode can be used to clamp V_{GS} to safe level. During startup, inrush current flows through the body diode to charge the bulk hold-up capacitors at the output. The maximum source current through the body diode must be higher than the inrush current that can be seen in the application.

To reduce the MOSFET conduction losses, lowest possible $R_{DS(ON)}$ is preferred, but selecting a MOSFET based on low $R_{DS(ON)}$ may not be beneficial always. Higher $R_{DS(ON)}$ will provide increased voltage information to SCT53600 reverse comparator at a lower reverse current. Reverse current detection is better with increased $R_{DS(ON)}$. It is recommended to operate the MOSFET in regulated conduction mode during nominal load conditions and select $R_{DS(ON)}$ such that at nominal operating current, forward voltage drop V_{DS} is close to 20 mV regulation point and not more than 50 mV.

As a guideline, it is suggested to choose $(20 \text{ mV} / I_{Load(Nominal)}) \leq R_{DS(ON)} \leq (50 \text{ mV} / I_{Load(Nominal)})$.

MOSFET manufacturers usually specify $R_{DS(ON)}$ at 4.5-V V_{GS} and 10-V V_{GS} . $R_{DS(ON)}$ increases drastically below 4.5-V V_{GS} and $R_{DS(ON)}$ is highest when V_{GS} is close to MOSFET V_{th} . For stable regulation at light load conditions, it is recommended to operate the MOSFET close to 4.5V V_{GS} , i.e., much higher than MOSFET gate threshold voltage. It is recommended to choose MOSFET gate threshold voltage V_{th} of 2-V to 2.5V maximum. Choosing a lower V_{th} MOSFET also reduces the turn ON time.

Based on the design requirements, preferred MOSFET ratings are:

- 60-V $V_{DS(MAX)}$ and ± 20 -V $V_{GS(MAX)}$
- $R_{DS(ON)}$ at 3A nominal current: $(20 \text{ mV} / 3 \text{ A}) \leq R_{DS(ON)} \leq (50 \text{ mV} / 3 \text{ A}) = 6.67 \text{ m}\Omega \leq R_{DS(ON)} \leq 16.67 \text{ m}\Omega$.
- MOSFET gate threshold voltage V_{th} : 2V maximum

Selection of TVS Diodes for 12V Battery Protection Applications

In the 12V battery protection application circuit shown in Figure 9, a bi-directional TVS diode is used to protect from positive and negative transient voltages that occur during normal operation of the car and these transient voltage levels and pulses are specified in ISO 7637-2 and ISO 16750-2 standards.

There are two important specifications, breakdown voltage and clamping voltage of the TVS. Breakdown voltage should be higher than worst case steady state voltages seen in the system. The breakdown voltage of the TVS+ should be higher than 24-V jump start voltage and 35-V suppressed load dump voltage and less than the maximum ratings of SCT53600 (65V). The breakdown voltage of TVS- should be beyond than maximum reverse battery voltage -16-V, so that the TVS- is not damaged due to long time exposure to reverse connected battery.

Clamping voltage is the voltage the TVS diode clamps in high current pulse situations and this voltage is much higher than the breakdown voltage. TVS diodes are meant to clamp transient pulses and should not interfere with steady state operation. In the case of an ISO 7637-2 pulse 1, the input voltage goes up to -150 V with a generator impedance of 10 Ω . This translates to 15 A flowing through the TVS - and the voltage across the TVS would be close to its clamping voltage.

In case of ISO 7637-2 pulse 1, the anode of SCT53600 is pulled down by the ISO pulse and clamped by TVS-. The MOSFET is turned off quickly to prevent reverse current from discharging the bulk output capacitors. When the MOSFET turns off, the cathode to anode voltage seen is equal to (TVS Clamping voltage + Output capacitor voltage). If the maximum voltage on output capacitor is 16 V (maximum battery voltage), then the clamping voltage of the TVS- should not exceed, $(60 \text{ V} - 16) \text{ V} = 44 \text{ V}$.

Application Waveforms

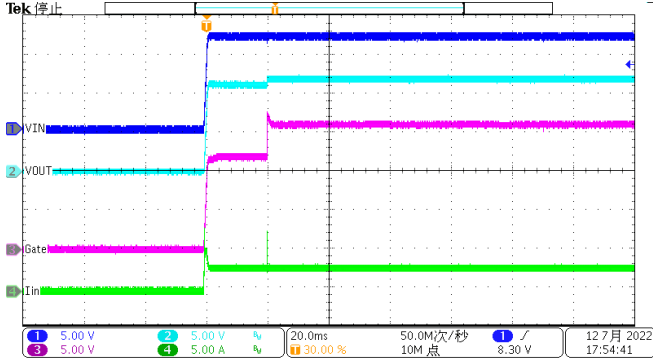

Figure 4. Start up with 3A load

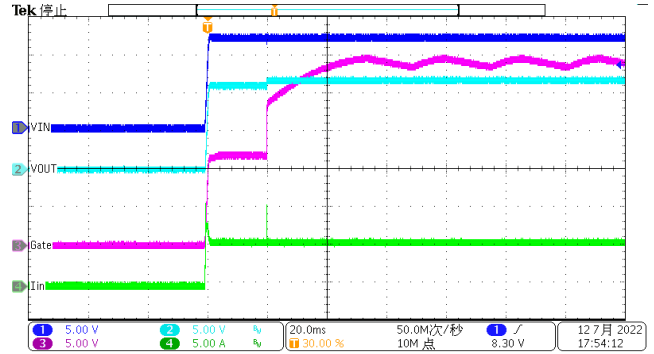

Figure 5. Start up with 5.8A load

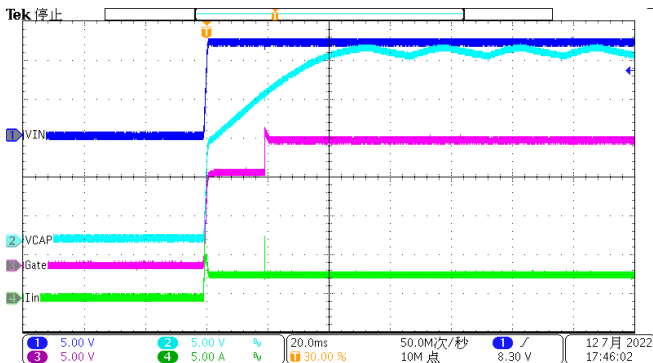

Figure 6. VCAP during startup at 3A load

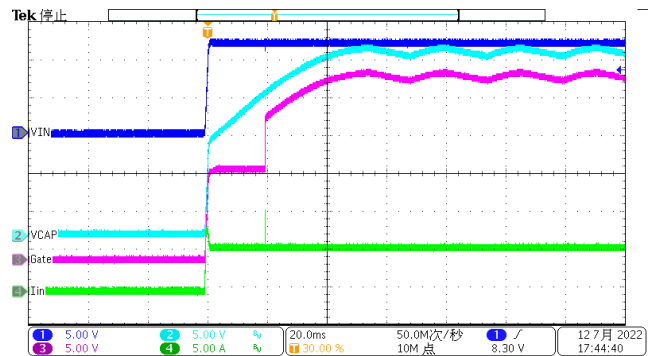

Figure 13. VCAP during startup at 5.8A load

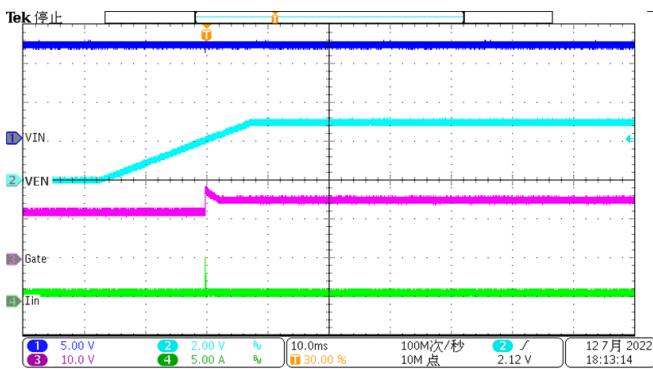

Figure 14. Enable Threshold

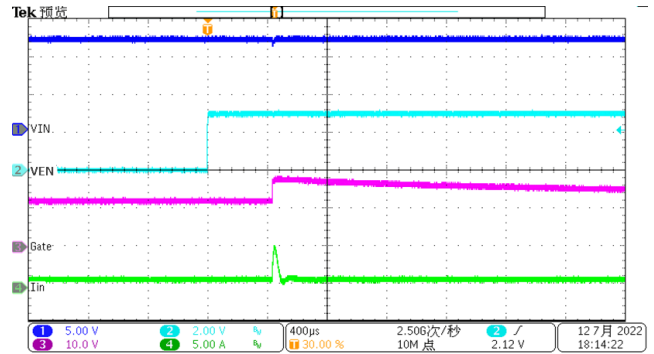

Figure 15. Enable turn on delay

Application Waveforms(continued)

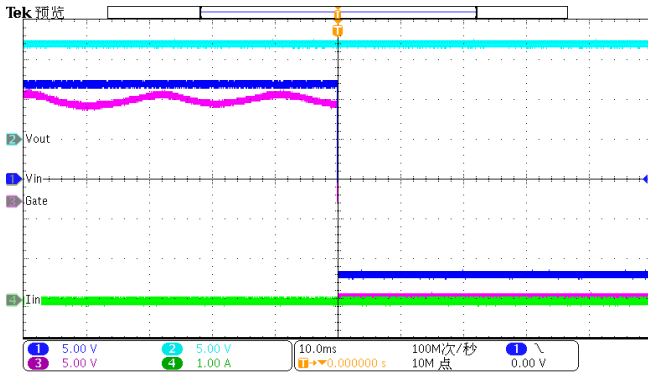

Figure 16. Static Reverse Polarity

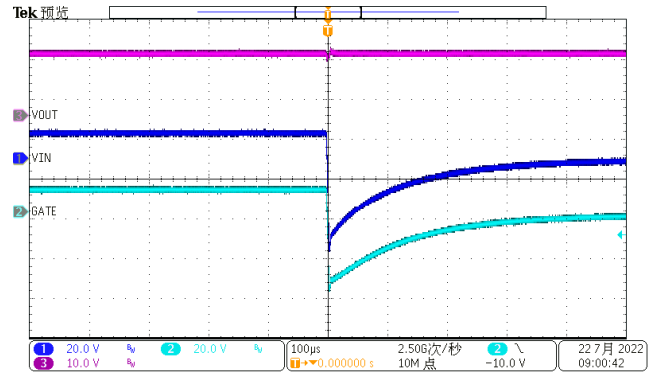

Figure 17. Dynamic Reverse Polarity(ISO 7637-2 Pulse 1)

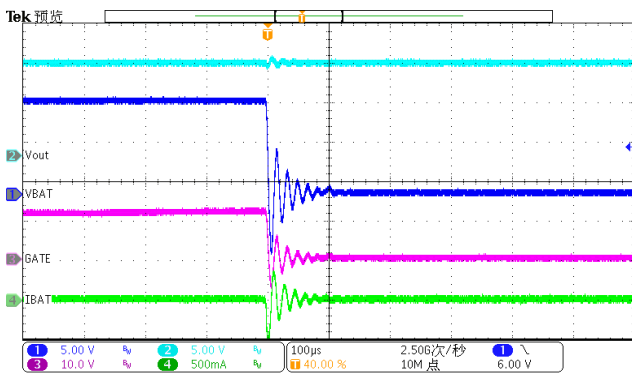

Figure 18. Input Short Response

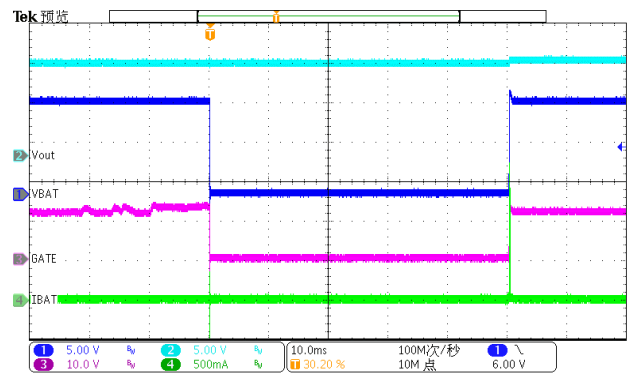

Figure 19. Input Micro-Short

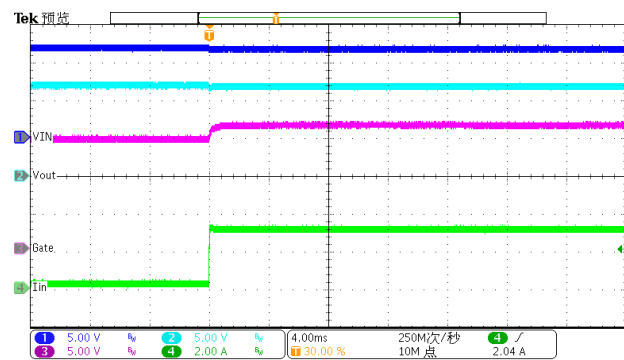

Figure 21. Load Transient Response, 0.1A->3A

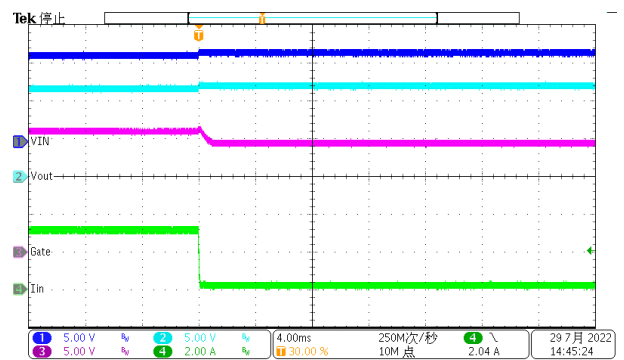

Figure 21. Load Transient Response, 3A->0.1A

SCT53600

APPLICATION INFORMATION

Typical Application- Redundant Power

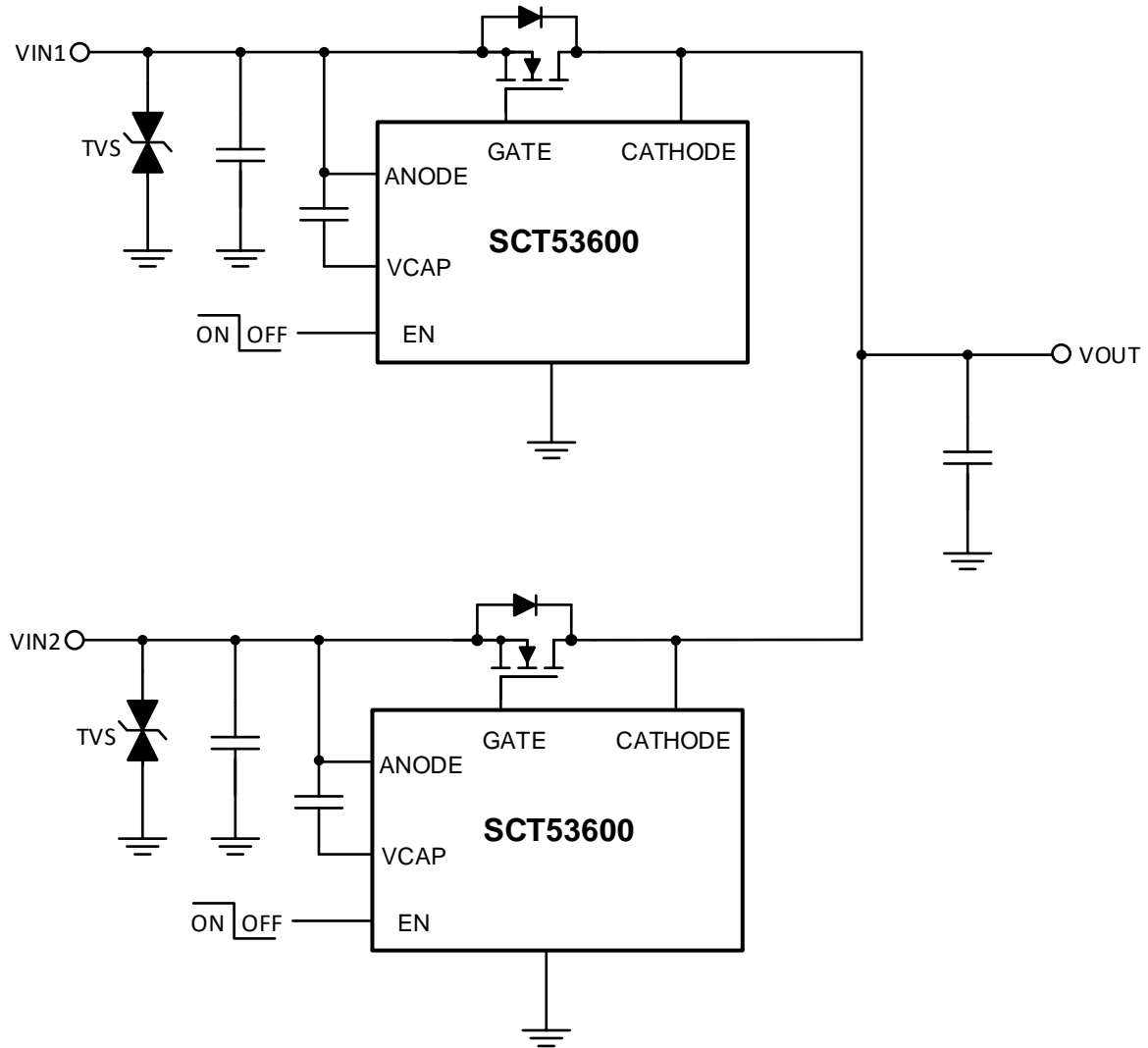

Figure 22. Redundant Power Supply Application

Application Waveforms

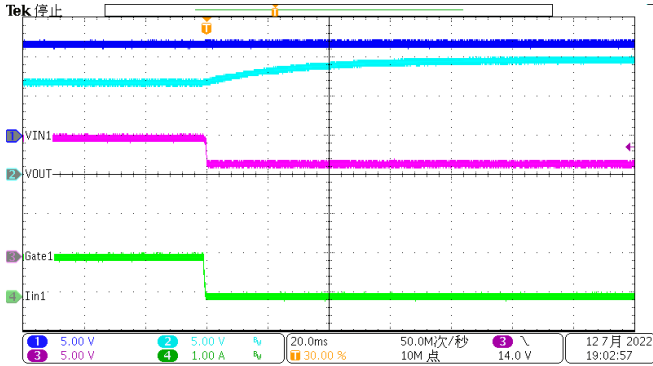

Figure 23. VIN1(12V) to VIN2(15V) Switch Over

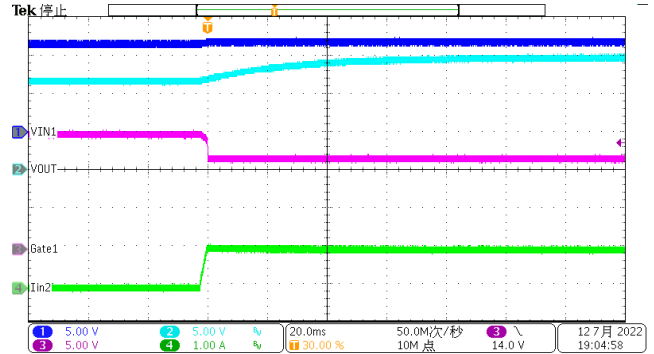

Figure 24. VIN1(12V) to VIN2(15V) Switch Over

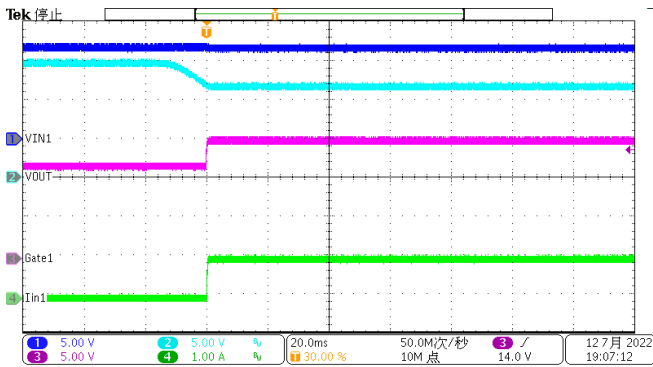

Figure 25. VIN2(15V) to VIN1(12V) Switch Over

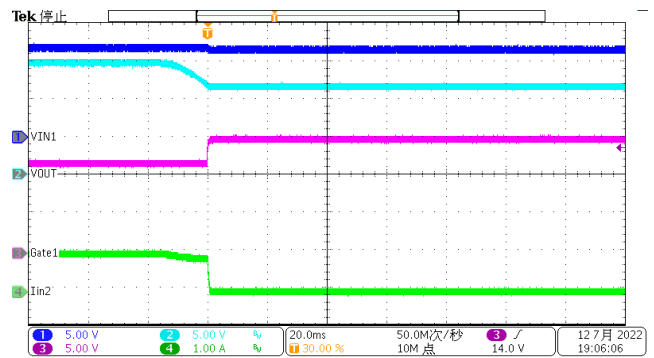

Figure 26. VIN2(15V) to VIN1(12V) Switch Over

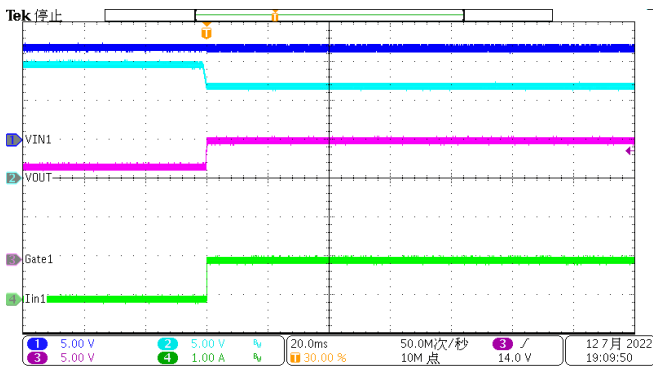

Figure 27. VIN2 Fail and Switch Over to VIN1

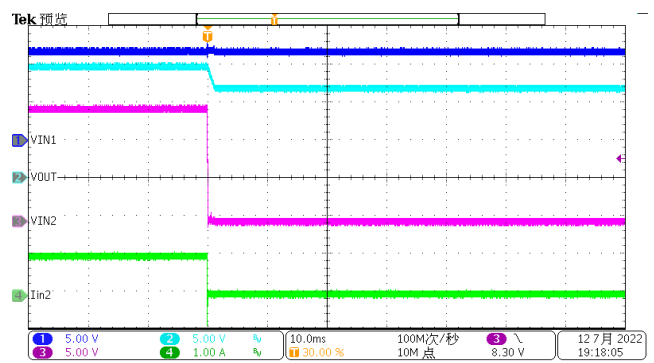
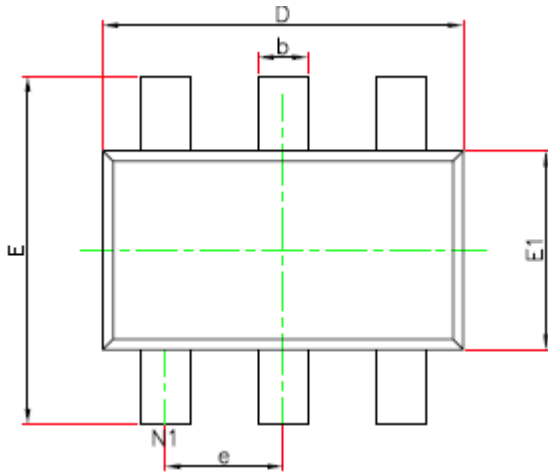
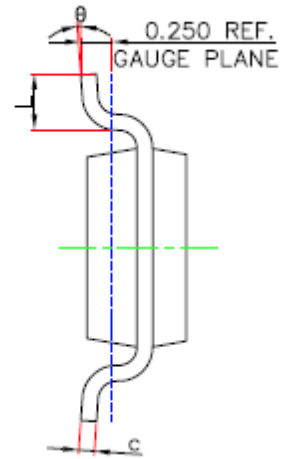

Figure 28. VIN2 Fail and Switch Over to VIN1

PACKAGE INFORMATION



TOP VIEW



BOTTOM VIEW

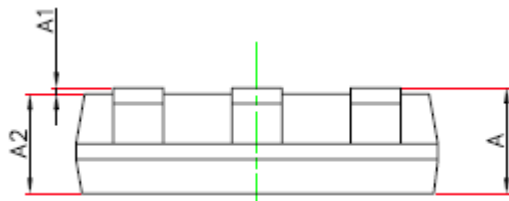

SIDE VIEW

NOTE:

1. Drawing proposed to be made a JEDEC package outline MO-220 variation.
2. Drawing not to scale.
3. All linear dimensions are in millimeters.
4. Thermal pad shall be soldered on the board.
5. Dimensions of exposed pad on bottom of package do not include mold flash.
6. Contact PCB board fabrication for minimum solder mask web tolerances between the pins.

SYMBOL	Unit: Millimeter		
	MIN	TYP	MAX
A	-----		1.10
A1	0.000		0.10
A2	0.70		1.00
D	2.85		2.95
E	2.65		2.95
E1	1.55		1.65
b	0.30		0.50
c	0.08		0.20
e	0.95(BSC)		
L	0.30		0.60
theta	0°		8°

