

Automotive-grade silicon carbide Power MOSFET 1200 V, 75 mΩ typ., 33 A in an HiP247-4 package

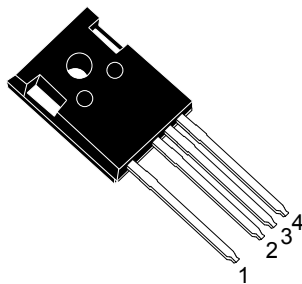

HiP247-4

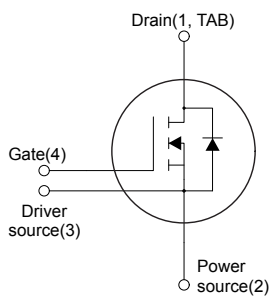

ND1TPS2DS3G4



Features

Order code	V _{DS}	R _{DS(on)} max.	I _D
SCTWA40N12G24AG	1200 V	105 mΩ	33 A

- AEC-Q101 qualified 
- Very fast and robust intrinsic body diode
- Extremely low gate charge and input capacitance
- Very high operating junction temperature capability (T_J = 200 °C)
- Source sensing pin for increased efficiency

Applications

- Main inverter (electric traction)
- DC/DC converter for EV/HEV
- On board charger (OBC)

Description

This silicon carbide Power MOSFET device has been developed using ST's advanced and innovative 2nd generation SiC MOSFET technology. The device features remarkably low on-resistance per unit area and very good switching performance. The variation of switching loss is almost independent of junction temperature.

Product status link

[SCTWA40N12G24AG](#)

Product summary

Order code	SCTWA40N12G24AG
Marking	SCT40N12G24AG
Package	HiP247-4
Packing	Tube

1 Electrical ratings

Table 1. Absolute maximum ratings

Symbol	Parameter	Value	Unit
V_{DS}	Drain-source voltage	1200	V
V_{GS}	Gate-source voltage	-10 to 22	V
	Gate-source voltage (recommended operating values)	-5 to 18	
	Gate-source voltage (pulsed, $t_p = 25$ ns repetitive overshoot during switching for an accumulated time of 10 h)	-11 to 25	
I_D	Drain current (continuous) at $T_C = 25$ °C	33	A
	Drain current (continuous) at $T_C = 100$ °C	25	
$I_{DM}^{(1)}$	Drain current (pulsed)	100	A
P_{TOT}	Total power dissipation at $T_C = 25$ °C	290	W
T_{stg}	Storage temperature range	-55 to 200	°C
T_J	Operating junction temperature range		°C

1. Pulse width limited by safe operating area.

Table 2. Thermal data

Symbol	Parameter	Value	Unit
R_{thJC}	Thermal resistance, junction-to-case	0.6	°C/W
R_{thJA}	Thermal resistance, junction-to-ambient	40	°C/W

2 Electrical characteristics

$T_C = 25\text{ °C}$ unless otherwise specified.

Table 3. On/off states

Symbol	Parameter	Test conditions	Min.	Typ.	Max.	Unit
$V_{(BR)DSS}$	Drain-source breakdown voltage	$V_{GS} = 0\text{ V}, I_D = 1\text{ mA}$	1200			V
I_{DSS}	Zero gate voltage drain current	$V_{DS} = 1200\text{ V}, V_{GS} = 0\text{ V}$			10	μA
I_{GSS}	Gate-body leakage current	$V_{DS} = 0\text{ V}, V_{GS} = -10\text{ to }22\text{ V}$			± 100	nA
$V_{GS(th)}$	Gate threshold voltage	$V_{DS} = V_{GS}, I_D = 1\text{ mA}$	1.9	3.2	5.0	V
$R_{DS(on)}$	Static drain-source on-resistance	$V_{GS} = 18\text{ V}, I_D = 20\text{ A}$		75	105	m Ω
		$V_{GS} = 18\text{ V}, I_D = 20\text{ A}, T_J = 200\text{ °C}$		195		

Table 4. Dynamic

Symbol	Parameter	Test conditions	Min.	Typ.	Max.	Unit
C_{iss}	Input capacitance	$V_{DS} = 800\text{ V}, f = 1\text{ MHz}, V_{GS} = 0\text{ V}$	-	1230	-	pF
C_{oss}	Output capacitance		-	56	-	pF
C_{rss}	Reverse transfer capacitance		-	15	-	pF
Q_g	Total gate charge	$V_{DS} = 800\text{ V}, V_{GS} = -5\text{ to }18\text{ V}, I_D = 20\text{ A}$	-	63	-	nC
Q_{gs}	Gate-source charge		-	15	-	nC
Q_{gd}	Gate-drain charge		-	20	-	nC
R_G	Gate input resistance	$f = 1\text{ MHz}, I_D = 0\text{ A}$	-	1	-	Ω

Table 5. Switching energy

Symbol	Parameter	Test conditions	Min.	Typ.	Max.	Unit
E_{on}	Turn-on switching energy	$V_{DD} = 800\text{ V}, I_D = 20\text{ A},$	-	235	-	μJ
E_{off}	Turn-off switching energy	$R_G = 4.7\ \Omega, V_{GS} = -5\text{ to }18\text{ V}$	-	77	-	μJ

Table 6. Switching times

Symbol	Parameter	Test conditions	Min.	Typ.	Max.	Unit
$t_{d(on)}$	Turn-on delay time	$V_{DD} = 800\text{ V}, I_D = 20\text{ A},$ $R_G = 4.7\ \Omega, V_{GS} = -5\text{ to }18\text{ V}$	-	11	-	ns
t_r	Rise time		-	5	-	ns
$t_{d(off)}$	Turn-off-delay time		-	18	-	ns
t_f	Fall time		-	13	-	ns

Table 7. Reverse SiC diode characteristics

Symbol	Parameter	Test conditions	Min.	Typ.	Max.	Unit
V_{SD}	Diode forward voltage	$I_{SD} = 20\text{ A}$, $V_{GS} = 0\text{ V}$	-	3.4	-	V
t_{rr}	Reverse recovery time	$I_{SD} = 20\text{ A}$, $di/dt = 2000\text{ A}/\mu\text{s}$, $V_{DD} = 800\text{ V}$, $V_{GS} = -5\text{ to }18\text{ V}$	-	19	-	ns
Q_{rr}	Reverse recovery charge		-	132	-	nC
I_{RRM}	Reverse recovery current		-	20	-	A

2.1 Electrical characteristics (curves)

Figure 1. Safe operating area

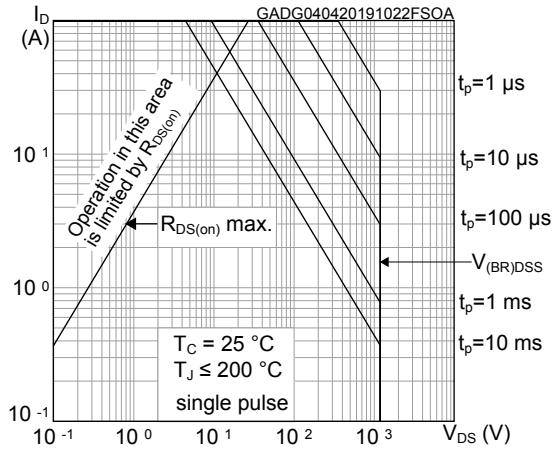

Figure 2. Maximum transient thermal impedance

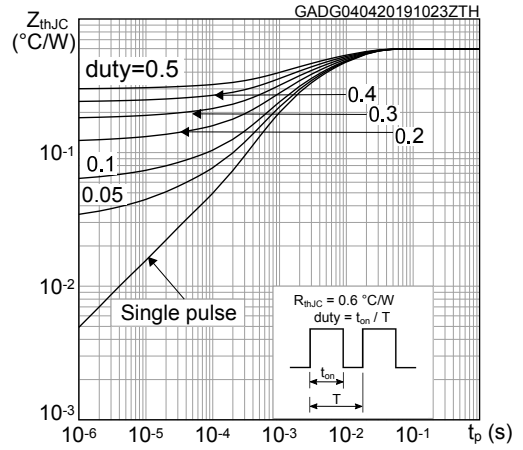

Figure 3. Output characteristics ($T_J = -50 \text{ }^\circ\text{C}$)

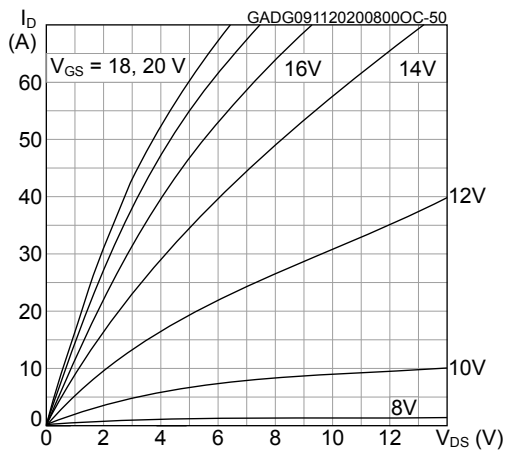

Figure 4. Output characteristics ($T_J = 25 \text{ }^\circ\text{C}$)

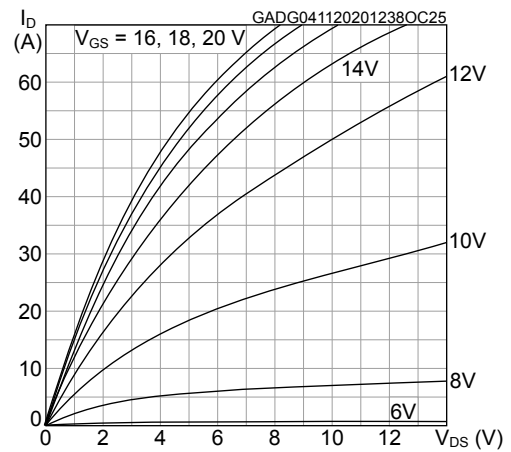

Figure 5. Output characteristics ($T_J = 200 \text{ }^\circ\text{C}$)

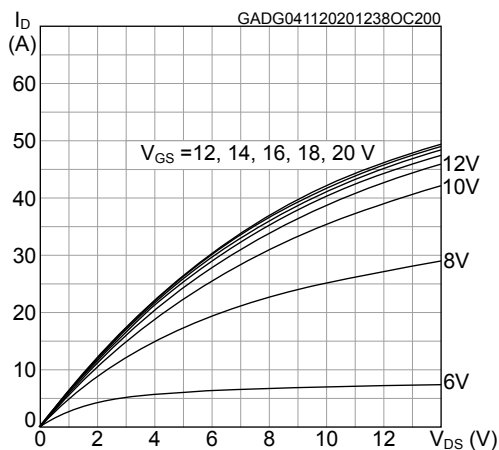

Figure 6. Transfer characteristics

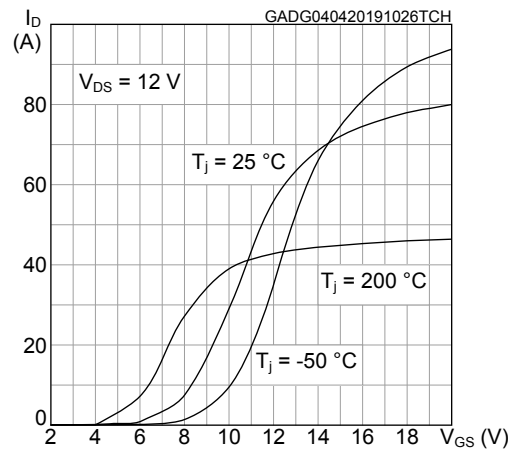

Figure 7. Total power dissipation

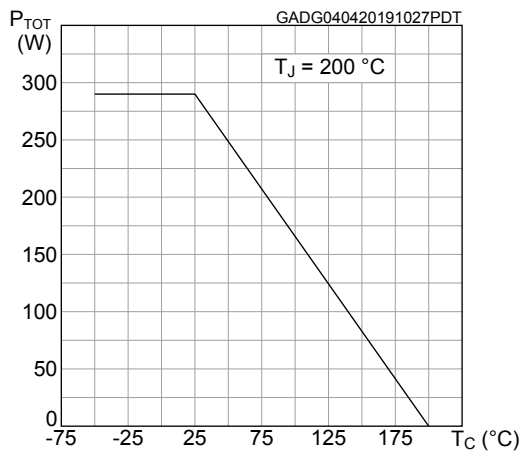

Figure 8. Gate charge vs gate-source voltage

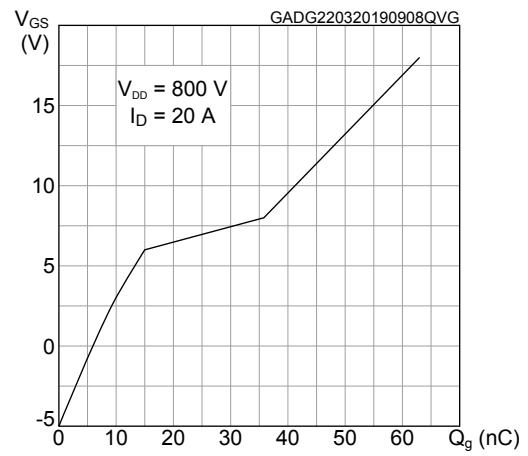

Figure 9. Capacitance variations

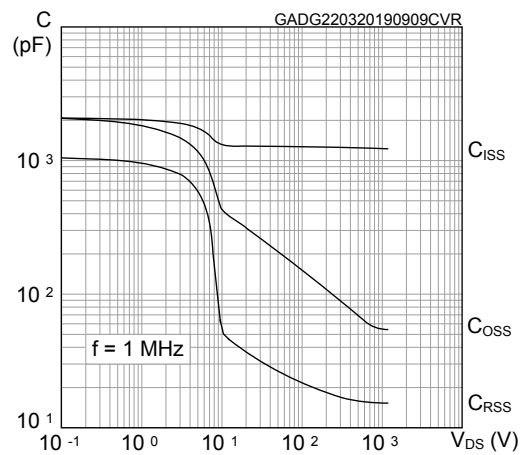

Figure 10. Switching energy vs drain current

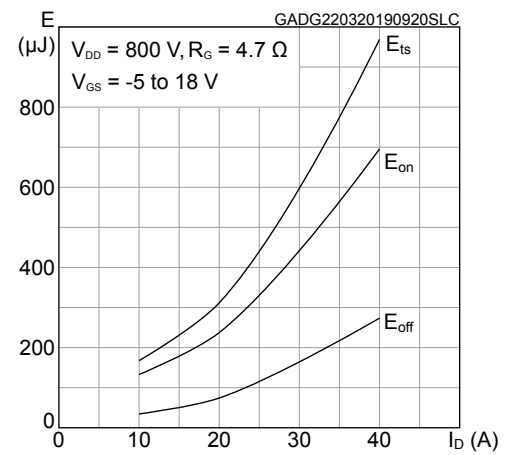

Figure 11. Switching energy vs junction temperature

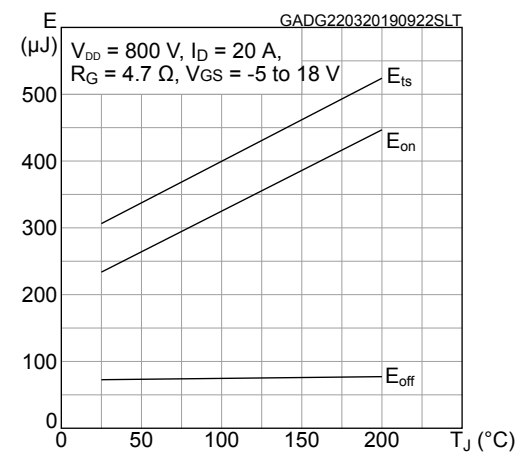

Figure 12. Normalized $V_{(BR)DSS}$ vs temperature

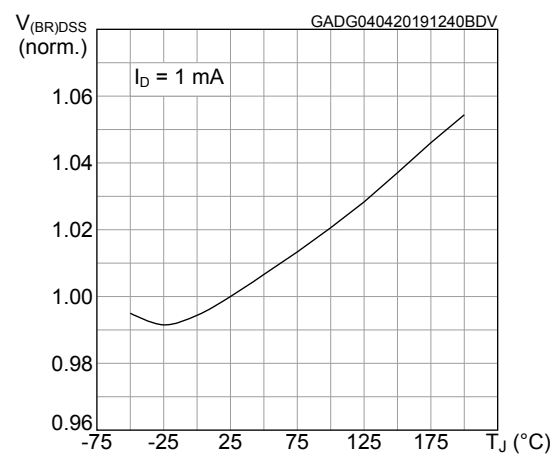

Figure 13. Normalized on-resistance vs temperature

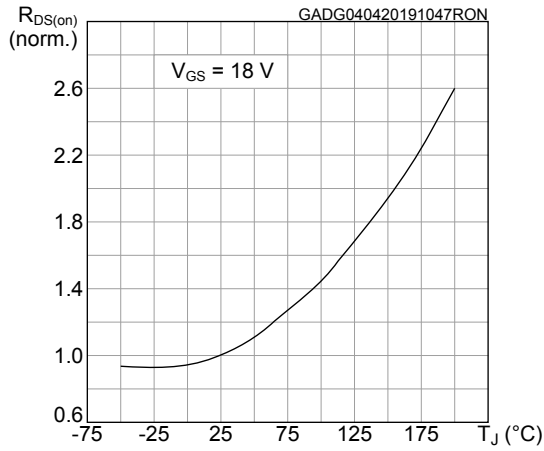

Figure 14. Normalized gate threshold voltage vs temperature

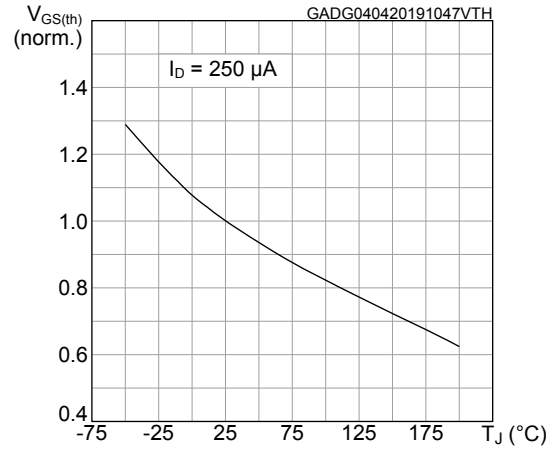

Figure 15. Reverse conduction characteristics ($T_J = -50$ °C)

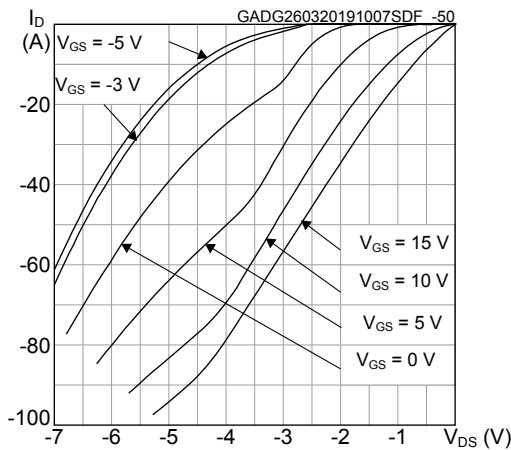

Figure 16. Reverse conduction characteristics ($T_J = 25$ °C)

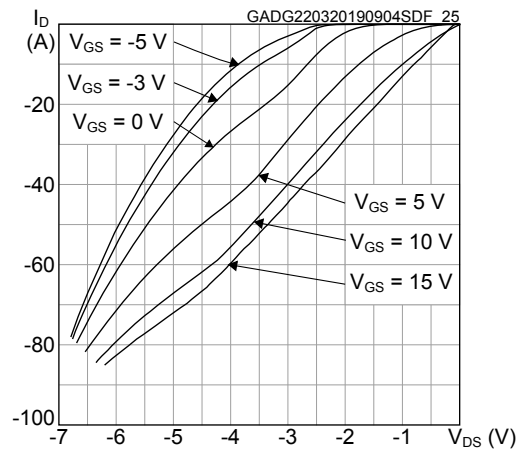
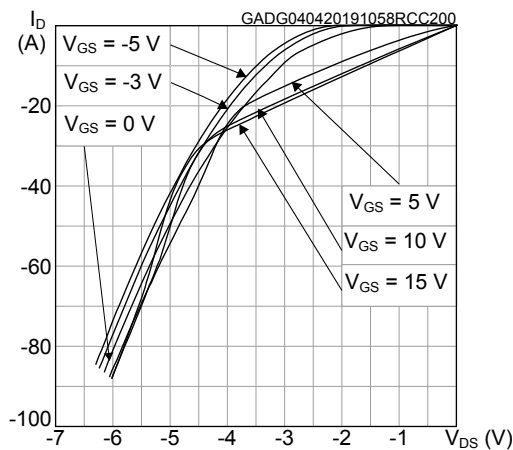

Figure 17. Reverse conduction characteristics ($T_J = 200$ °C)



3 Package information

In order to meet environmental requirements, ST offers these devices in different grades of **ECOPACK** packages, depending on their level of environmental compliance. ECOPACK specifications, grade definitions and product status are available at: www.st.com. ECOPACK is an ST trademark.

3.1 HiP247-4 package information

Figure 18. HiP247-4 package outline

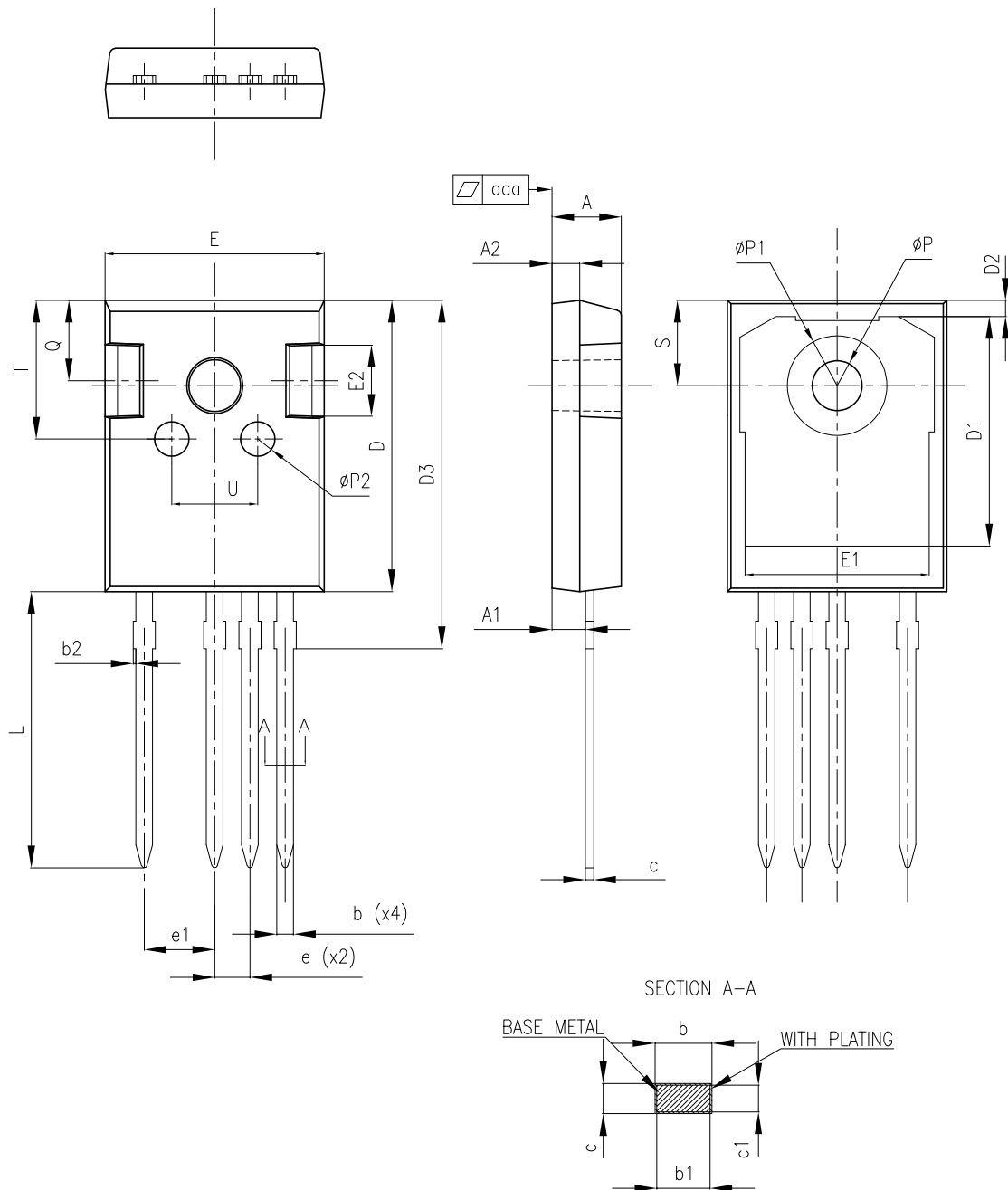

Table 8. HiP247-4 mechanical data

Dim.	mm		
	Min.	Typ.	Max.
A	4.90	5.00	5.10
A1	2.31	2.41	2.51
A2	1.90	2.00	2.10
b	1.16		1.29
b1	1.15	1.20	1.25
b2	0		0.20
c	0.59		0.66
c1	0.58	0.60	0.62
D	20.90	21.00	21.10
D1	16.25	16.55	16.85
D2	1.05	1.20	1.35
D3	24.97	25.12	25.27
E	15.70	15.80	15.90
E1	13.10	13.30	13.50
E2	4.90	5.00	5.10
E3	2.40	2.50	2.60
e	2.44	2.54	2.64
e1	4.98	5.08	5.18
L	19.80	19.92	20.10
P	3.50	3.60	3.70
P1			7.40
P2	2.40	2.50	2.60
Q	5.60		6.00
S		6.15	
T	9.80		10.20
U	6.00		6.40
aaa		0.04	0.10

Revision history

Table 9. Document revision history

Date	Revision	Changes
24-Nov-2020	1	First release.
24-Jun-2021	2	Updated <i>Table 6. Switching times.</i>
27-Sep-2021	3	Modified <i>Table 1. Absolute maximum ratings.</i>
22-Nov-2021	4	Modified <i>Figure 1. Safe operating area</i> and <i>Figure 2. Maximum transient thermal impedance.</i>

Contents

1	Electrical ratings	2
2	Electrical characteristics	3
2.1	Electrical characteristics (curves)	5
3	Package information	8
3.1	HiP247-4 package information	8
	Revision history	10

IMPORTANT NOTICE – PLEASE READ CAREFULLY

STMicroelectronics NV and its subsidiaries (“ST”) reserve the right to make changes, corrections, enhancements, modifications, and improvements to ST products and/or to this document at any time without notice. Purchasers should obtain the latest relevant information on ST products before placing orders. ST products are sold pursuant to ST’s terms and conditions of sale in place at the time of order acknowledgement.

Purchasers are solely responsible for the choice, selection, and use of ST products and ST assumes no liability for application assistance or the design of Purchasers’ products.

No license, express or implied, to any intellectual property right is granted by ST herein.

Resale of ST products with provisions different from the information set forth herein shall void any warranty granted by ST for such product.

ST and the ST logo are trademarks of ST. For additional information about ST trademarks, please refer to www.st.com/trademarks. All other product or service names are the property of their respective owners.

Information in this document supersedes and replaces information previously supplied in any prior versions of this document.

© 2021 STMicroelectronics – All rights reserved