

SD107WS

SURFACE MOUNT SCHOTTKY BARRIER DIODE

Features

- Low forward voltage drop

PINNING

PIN	DESCRIPTION
1	Cathode
2	Anode

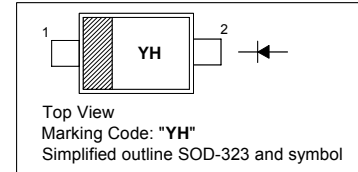

Absolute Maximum Ratings ($T_a = 25\text{ }^\circ\text{C}$)

Parameter	Symbol	Value	Unit
Repetitive Peak Reverse Voltage	V_{RRM}	30	V
Non-Repetitive Peak Reverse Voltage	V_{RSM}	30	V
DC Blocking Voltage	V_R	30	V
Forward Continuous Current	I_{FM}	100	mA
Non-Repetitive Peak Forward Surge Current ($t \leq 10\text{ ms}$)	I_{FSM}	750	mA
Power Dissipation	P_d	250	mW
Operating and Storage Temperature Range	T_j, T_s	- 65 to + 125	$^\circ\text{C}$

Characteristics at $T_a = 25\text{ }^\circ\text{C}$

Parameter	Symbol	Min.	Max.	Unit
Forward Voltage at $I_F = 50\text{ mA}$ at $I_F = 100\text{ mA}$	V_F	- -	0.55 0.8	V
Reverse Breakdown Voltage at $I_R = 100\text{ }\mu\text{A}$	$V_{(BR)R}$	30	-	V
Reverse Current at $V_R = 25\text{ V}$	I_R	-	1	μA

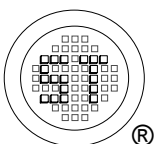

SEMTECH ELECTRONICS LTD.

(Subsidiary of Sino-Tech International Holdings Limited, a company
listed on the Hong Kong Stock Exchange, Stock Code: 724)



ISO/TS 16949 : 2002
Certificate No. 05103



ISO 14001:2004
Certificate No. 7116



ISO 9001:2000
Certificate No. 0506098

Dated : 29/11/2007

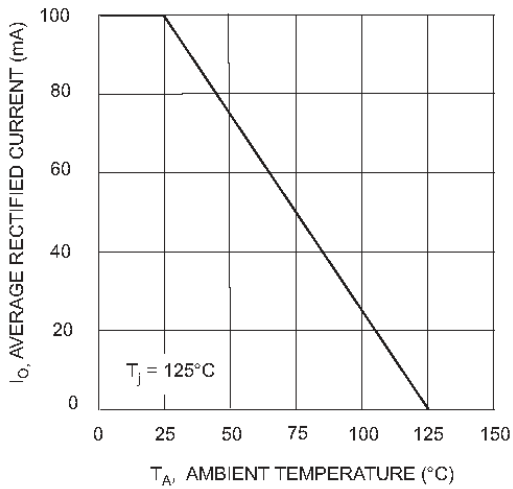

T_A , AMBIENT TEMPERATURE ($^\circ\text{C}$)
Fig. 1 Forward Current Derating Curve

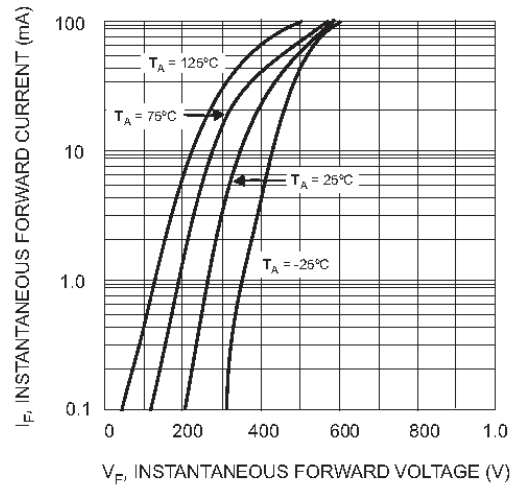

V_F , INSTANTANEOUS FORWARD VOLTAGE (V)
Fig. 2 Typical Forward Characteristics

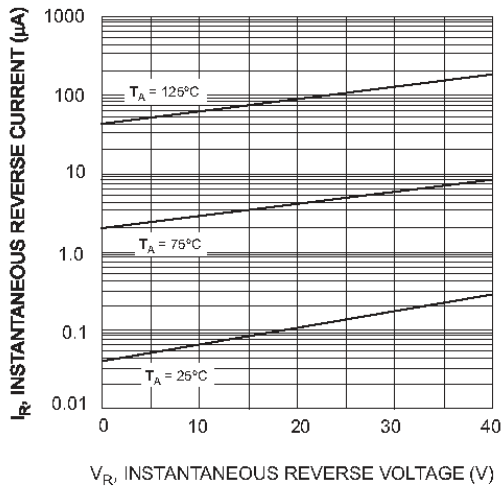

V_R , INSTANTANEOUS REVERSE VOLTAGE (V)
Fig. 3 Typical Reverse Characteristics

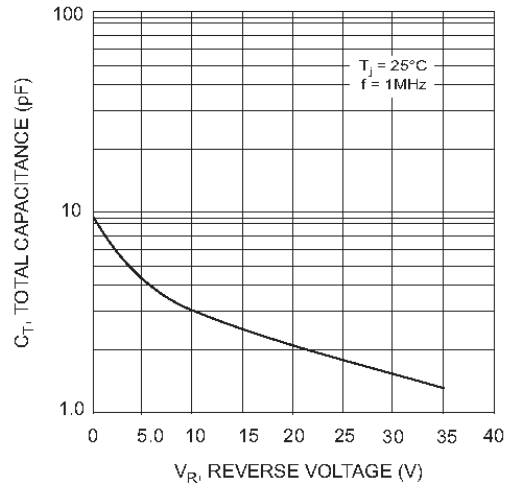

V_R , REVERSE VOLTAGE (V)
Fig. 4 Total Capacitance vs. Reverse Voltage

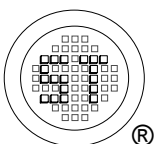

SEMTECH ELECTRONICS LTD.
(Subsidiary of Sino-Tech International Holdings Limited, a company listed on the Hong Kong Stock Exchange, Stock Code: 724)



ISO/TS 16949 : 2002
Certificate No. 05103



ISO 14001:2004
Certificate No. 7116



ISO 9001:2000
Certificate No. 0506098

SD107WS

PACKAGE OUTLINE

Plastic surface mounted package; 2 leads

SOD-323

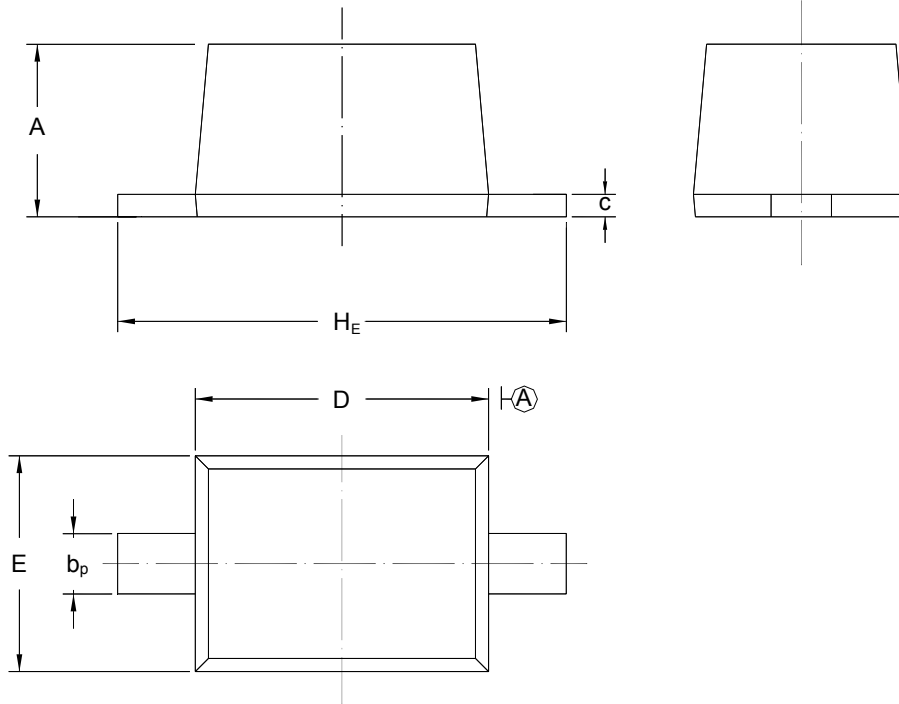

UNIT	A	b _p	C	D	E	H _E
mm	1.10 0.80	0.40 0.25	0.15 0.00	1.80 1.60	1.35 1.15	2.80 2.30

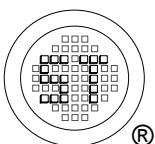

SEMTECH ELECTRONICS LTD.
 (Subsidiary of Sino-Tech International Holdings Limited, a company
 listed on the Hong Kong Stock Exchange, Stock Code: 724)



ISO/TS 16949 : 2002 Certificate No. 05103
 ISO 14001:2004 Certificate No. 7116
 ISO 9001:2000 Certificate No. 0506098

Dated : 29/11/2007