

$$V_{DS} = 1200V$$

$$R_{DSon} = 32m\Omega$$

$$I_D = 50A @ T_c = 25^\circ C$$

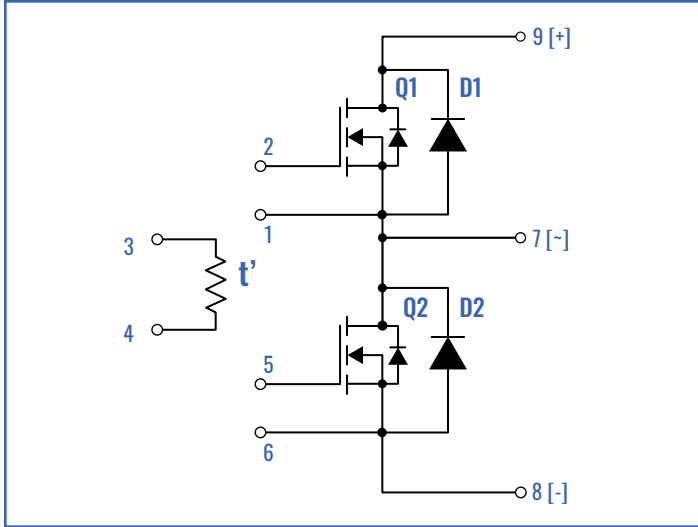

### PIN CONNECTIONS

PIN	DESCRIPTION
1	S1
2	G1
3	Temp. Monitoring
4	Temp. Monitoring
5	G2
6	S2
7	AC
8	N
9	P

### FEATURES & BENEFITS

- SUPERIOR SYSTEM EFFICIENCY DUE TO LOW SWITCHING AND CONDUCTIONS LOSSES OF SiC
- OUTSTANDING POWER CONVERSION EFFICIENCY AT HIGH FREQUENCY OPERATION
- HIGH SPEED SWITCHING W/ LOW CAPACITANCE
- REDUCED PARASITIC INDUCTANCE AND CAPACITANCE
- REAL KELVIN SOURCE CONNECTION FOR STABLE GATE DRIVE
- ISOLATED BACKSIDE FOR DIRECT MOUNT TO HEATSINK
- ALN SUBSTRATE AND CUMO BASEPLATE FOR THERMAL CONDUCTIVITY
- HIGH JUNCTION TEMPERATURE OPERATION
- LOW JUNCTION TO CASE THERMAL RESISTANCE
- REDUCED THERMAL REQUIREMENTS AND SYSTEM COST
- INTEGRATED NTC TEMPERATURE SENSOR
- RUGGED MOUNTING DUE TO INTEGRATED MOUNTING BUSHINGS
- LOW PROFILE COMPACT PACKAGE



### ABSOLUTE MAXIMUM RATINGS ( $T_c = 25^\circ\text{C}$ )

SYMBOL	CHARACTERISTIC	TEST CONDITIONS	VALUE	UNIT
$V_{DS,max}$	Drain-Source Voltage	$V_{GS} = 0V, I_D = 19\mu A$	1200	V
$V_{GS,max}$	Gate-Source Voltage (Max.)	Absolute maximum values	-8/+19	V
$V_{GS,op}$	Gate-Source Voltage	Recommended operational values	-4/+15	V
$I_D$	Continuous Drain Current	$V_{GS} = 15V$	50	A
$I_{D,pulse}$	Pulsed Drain Current	Pulse Width $t_p$ Limited by $T_{jmax}$	160	A
$P_D$	Maximum Power Dissipation		176	W
$T_j, T_{STG}$	Junction Temperature, Operating and Storage		-55 to +175	$^\circ\text{C}$

### ELECTRICAL CHARACTERISTICS ( $T_c = 25^\circ\text{C}$ )

SYMBOL	CHARACTERISTIC	TEST CONDITIONS	MIN.	TYP.	MAX.	UNIT
$V_{(BR)DSS}$	Drain-Source Breakdown Voltage	$V_{GS} < 0V, I_D = 19\mu A$		1356		V
$V_{GS(th)}$	Gate Threshold Voltage	$V_{DS} = V_{GS}, I_{DS} = 11mA, T_a = -55^\circ\text{C}$		3.7		V
		$V_{DS} = V_{GS}, I_{DS} = 11mA, T_a = +25^\circ\text{C}$		2.5		
		$V_{DS} = V_{GS}, I_{DS} = 11mA, T_a = +175^\circ\text{C}$		2.1		
$I_{DSS}$	Off-State Drain Current	$V_{GS} = 0V, V_{DS} = 1200V$		1		$\mu A$
$I_{GSS}$	Gate-Source Leakage Current	$V_{GS} = +15V, V_{DS} = 0V$		10		nA
$R_{DS(on)}$	Drain-Source On-state Resistance	$V_{GS} = 15V, I_D = 40A, T_j = 25^\circ\text{C}$		33		m $\Omega$
		$V_{GS} = 15V, I_D = 40A, T_j = 175^\circ\text{C}$		46		
$g_{fs}$	Transconductance	$V_{DS} = 20V, I_{DS} = 40A, T_a = 25^\circ\text{C}$		29		S
		$V_{DS} = 20V, I_{DS} = 40A, T_a = 175^\circ\text{C}$		23		
$C_{iss}^*$	Input Capacitance	$V_{GS} = 0V, V_{DS} = 1000V, f = 100kHz, Vac = 25mV$		3357		pF
$C_{oss}^*$	Output Capacitance			129		pF
$C_{riss}^*$	Reverse Transfer Capacitance			8		pF

### BODY DIODE RATINGS AND CHARACTERISTICS ( $T_c = 25^\circ\text{C}$ )

SYMBOL	CHARACTERISTIC	TEST CONDITIONS	MIN.	TYP.	MAX.	UNIT
$V_{SD}$	Diode Forward Voltage	$V_{GS} = 0V$		4.25		V
$t_{rr}$	Reverse Recovery Time			27		nS
$Q_{rr}$	Reverse Recovery Charge			478		nC
$I_{rrm}$	Peak Reverse Recovery Current	PW < 10 $\mu$ s, Duty Cycle < 1%, Non-repetitive		27		A

### THERMAL RESISTANCE

SYMBOL	CHARACTERISTIC	TEST CONDITIONS	MIN.	TYP.	MAX.	UNIT
$R_{thJC}$	Junction-to-Case				0.4	$^\circ\text{C/W}$
$R_{thCS}$	Case-to-sink			0.21		$^\circ\text{C/W}$
$R_{thJA}$	Junction-to-Ambient				40	$^\circ\text{C/W}$

### SiC DIODE RATINGS AND CHARACTERISTICS ( $T_a = 25^\circ\text{C}$ )

SYMBOL	CHARACTERISTIC	TEST CONDITIONS	MIN.	TYP.	MAX.	UNIT
$I_F$	Continuous Forward Current	Limited by $T_j$			10	A
$I_{FSM}$	Surge No Repetitive Forward Current	PW < 10 $\mu$ s, Duty Cycle < 1%, Non-repetitive			170	A
$V_{DSS}$	Reverse Voltage				1200	V
$V_F$	Diode Forward Voltage	$V_{GS} = 0V, I_F = 10A$		1.5	1.6	V
C	Total Capacitance	$V_R = 1V, f = 1MHz$		550		pF

#### TEMPERATURE SENSOR NTC

SYMBOL	CHARACTERISTIC	MIN.	TYP.	MAX.	UNIT
$R_{25}$	Resistance @ 25°C		4.7		k $\Omega$
$\Delta R_{25}/R_{25}$	Resistance tolerance		±5		%
$\Delta B/B$	Beta tolerance		±3		%
$B_{25/100}$	Beta Constant		4110		K

#### CHARACTERISTICS

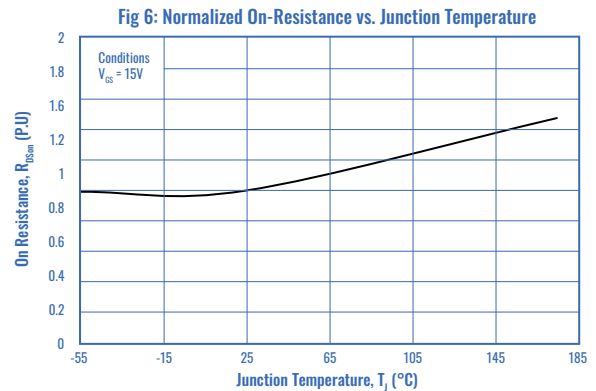
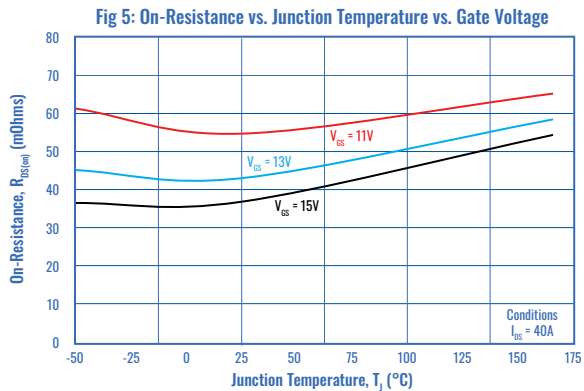
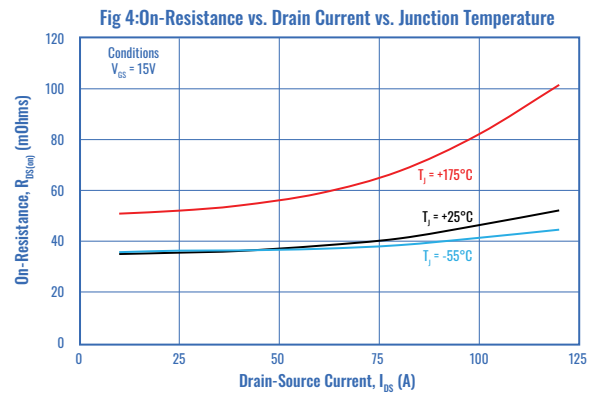
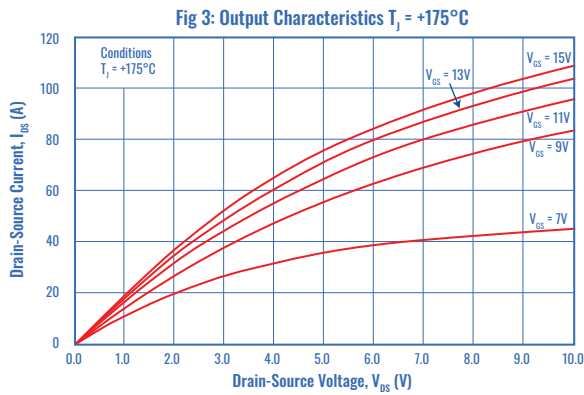
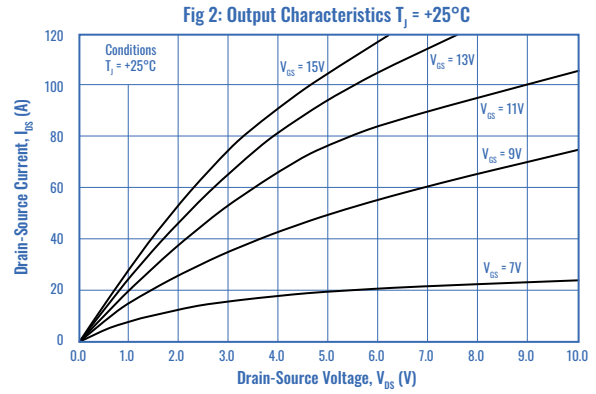
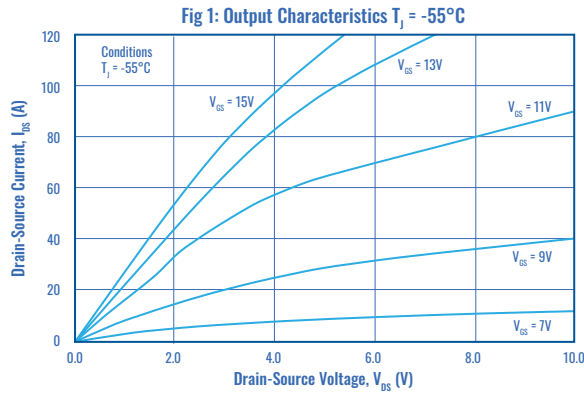

### CHARACTERISTICS, CONT.

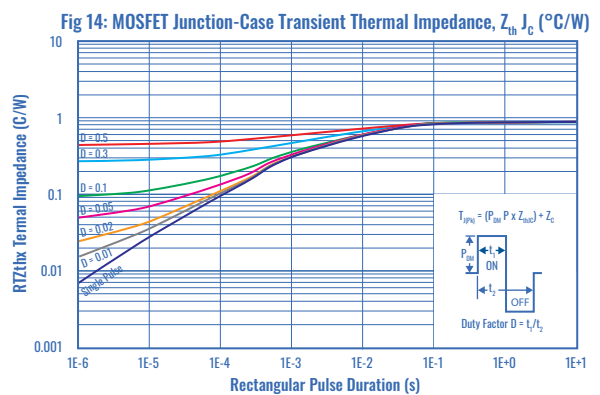
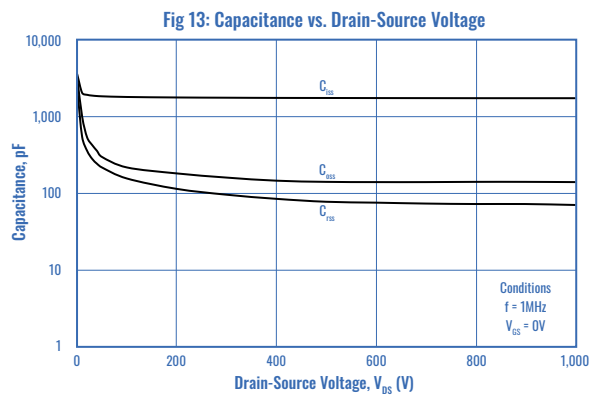
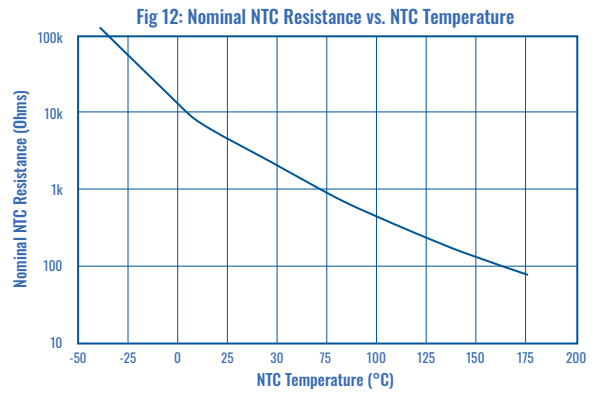
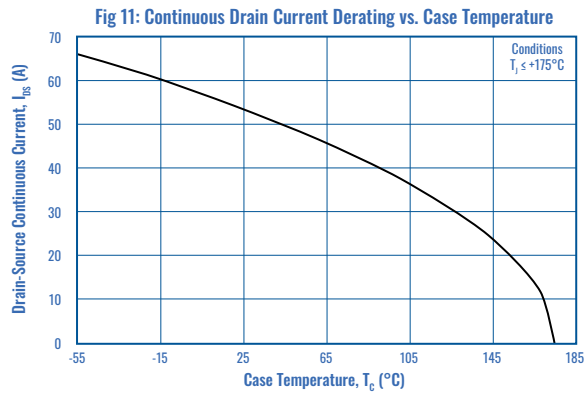
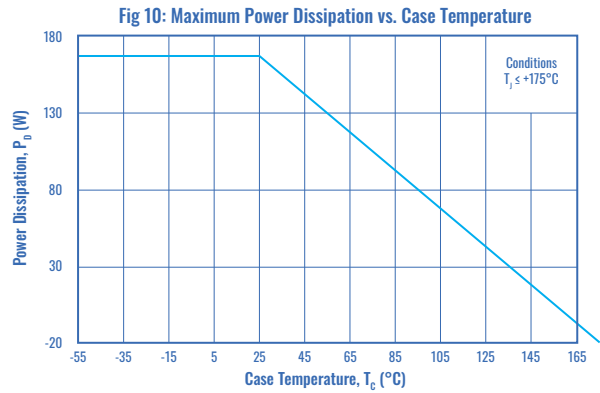
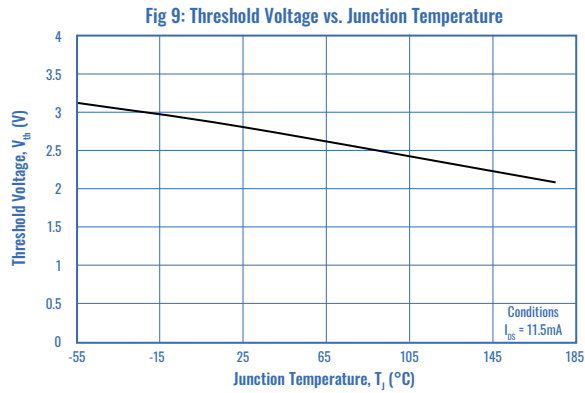
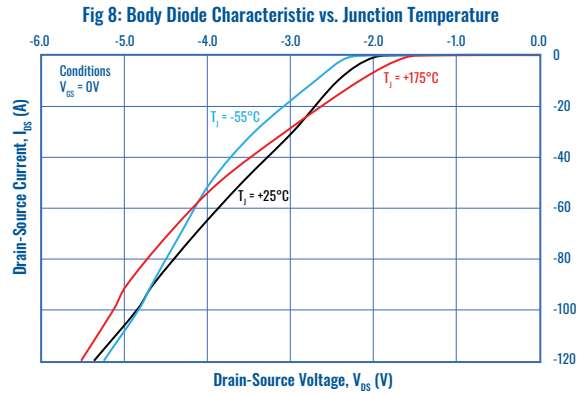
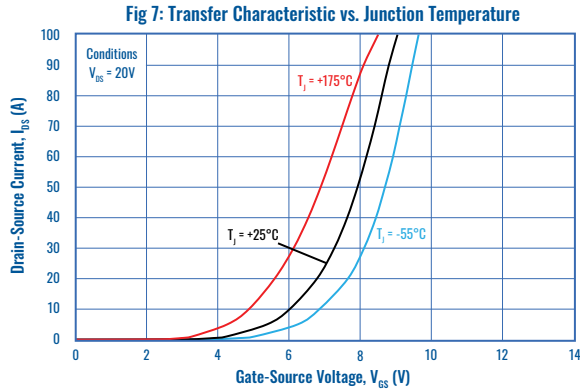

#### PACKAGE OUTLINE - dimensions in inches (mm)

