

RF & MICROWAVE TRANSISTORS UHF BASE STATION APPLICATIONS

PRELIMINARY DATA

- 470 MHZ
- 24 VOLTS
- $P_{OUT} = 1.5\text{ W}$ WITH 13.0 dB MIN. GAIN
- CLASS A
- COMMON EMITTER
- POWER SATURATION 2.2 W MIN.

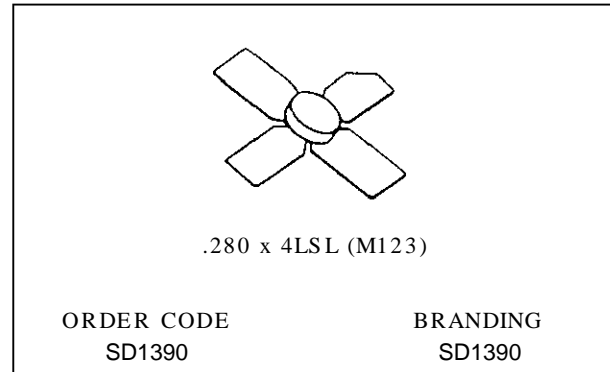

DESCRIPTION

The SD1390 is a gold metallized NPN planar transistor using diffused emitter ballast resistors for reliability and ruggedness.

The SD1390 is specifically designed as a low power, high gain driver and can be operated in Class A, B or C.

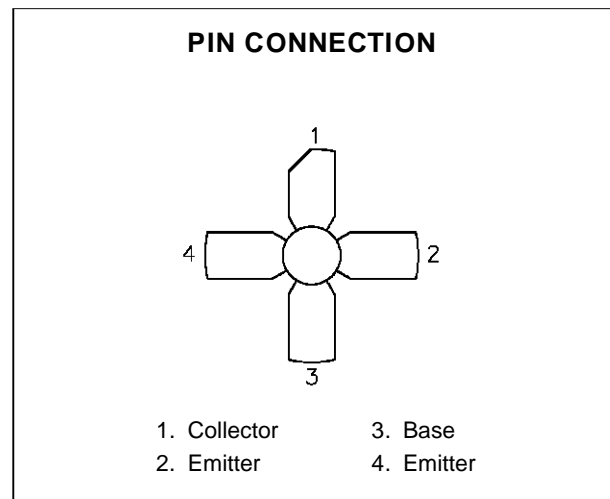

ABSOLUTE MAXIMUM RATINGS ($T_{case} = 25^{\circ}\text{C}$)

Symbol	Parameter	Value	Unit
V_{CBO}	Collector-Base Voltage	40	V
V_{CEO}	Collector-Emitter Voltage	24	V
V_{EBO}	Emitter-Base Voltage	3.5	V
I_C	Collector Current	0.35	A
P_{DISS}	Power Dissipation ($T_C \leq +75^{\circ}\text{C}$)	8.33	W
T_J	Junction Temperature	+200	$^{\circ}\text{C}$
T_{STG}	Storage Temperature	- 65 to +150	$^{\circ}\text{C}$

THERMAL DATA

$R_{TH(j-c)}$	Junction-Case Thermal Resistance	12	$^{\circ}\text{C}/\text{W}$
---------------	----------------------------------	----	-----------------------------

ELECTRICAL SPECIFICATIONS ($T_{\text{case}} = 25^{\circ}\text{C}$)

STATIC

Symbol	Test Conditions		Value			Unit
			Min.	Typ.	Max.	
BV_{CBO}	$I_{\text{C}} = 1 \text{ mA}$	$I_{\text{E}} = 0 \text{ mA}$	40	—	—	V
BV_{CEO}	$I_{\text{C}} = 1 \text{ mA}$	$I_{\text{B}} = 0 \text{ mA}$	24	—	—	V
BV_{EBO}	$I_{\text{E}} = 1 \text{ mA}$	$I_{\text{C}} = 0 \text{ mA}$	3.5	—	—	V
I_{CBO}	$V_{\text{CB}} = 24 \text{ V}$	$I_{\text{E}} = 0 \text{ mA}$	—	—	1.0	mA
hFE	$V_{\text{CE}} = 5 \text{ V}$	$I_{\text{C}} = 0.1 \text{ A}$	20	—	120	—

DYNAMIC

Symbol	Test Conditions				Value			Unit
					Min.	Typ.	Max.	
P_{OUT}	$f = 470 \text{ MHz}$	$P_{\text{IN}} = 75 \text{ mW}$	$V_{\text{CC}} = 24 \text{ V}$	$I_{\text{CQ}} = 200 \text{ mA}$	1.5	—	—	W
C_{OB}	$f = 1 \text{ MHz}$	$V_{\text{CB}} = 28 \text{ V}$			—	—	5.0	pF

TYPICAL PERFORMANCE

OUTPUT POWER vs INPUT POWER

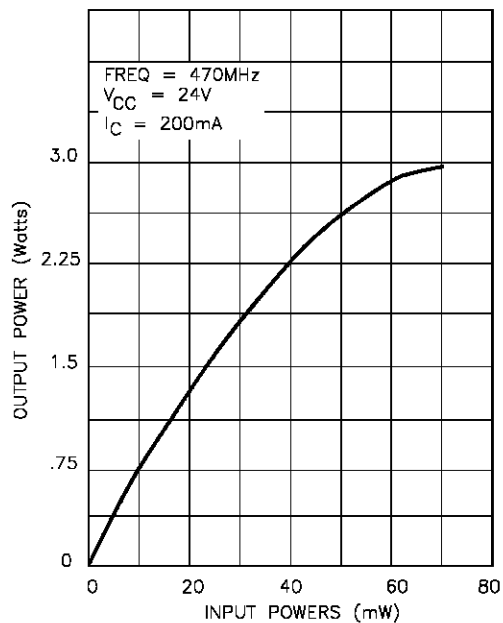

POWER GAIN vs FREQUENCY

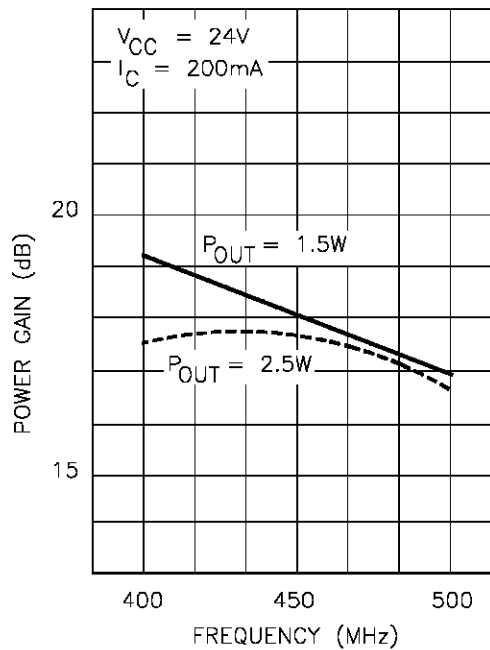

INPUT RETURN LOSS vs FREQUENCY

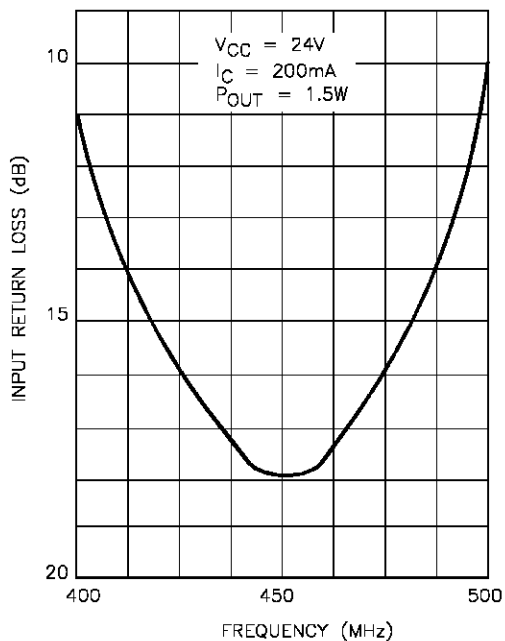

TEST CIRCUIT

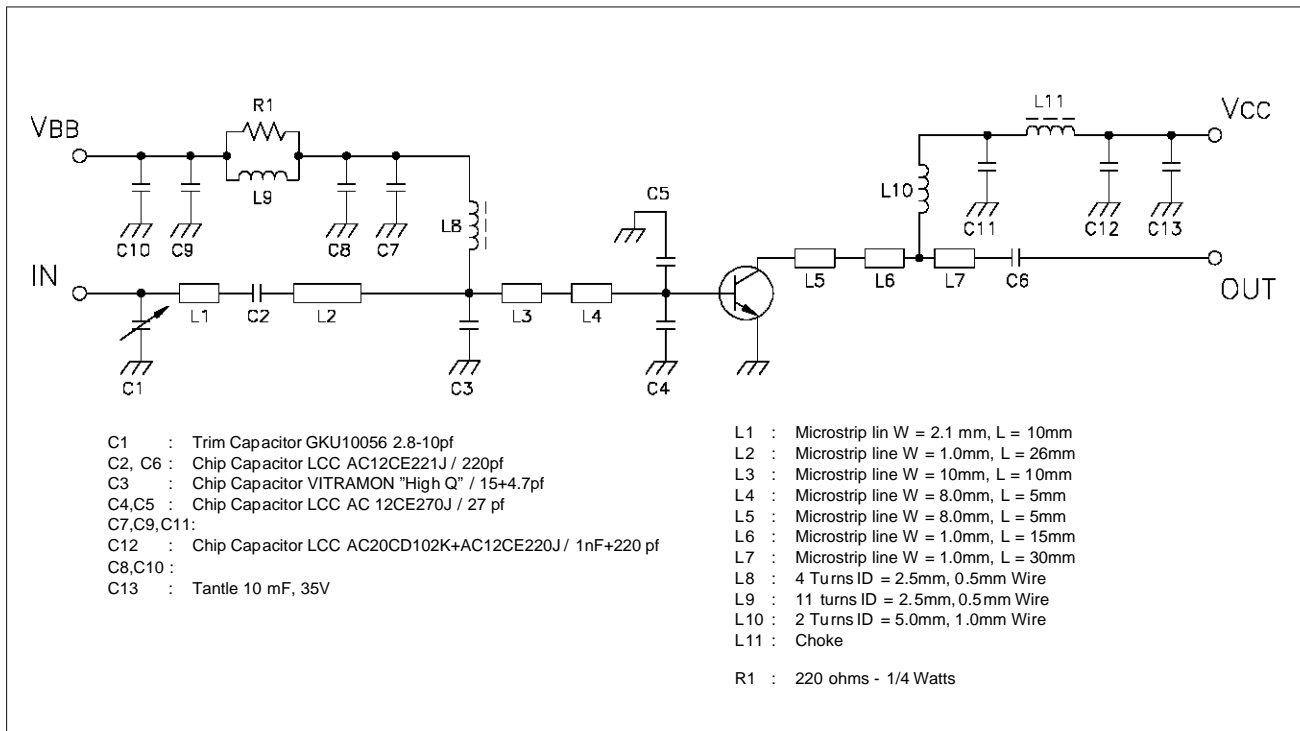

IMPEDANCE DATA

TYPICAL INPUT IMPEDANCE

TYPICAL COLLECTOR LOAD IMPEDANCE

FREQ.	Z _{IN} (Ω)	Z _{CL} (Ω)
400 MHz	2.8 + j 3.0	33 + j 47
430 MHz	2.6 + j 4.0	36 + j 49
470 MHz	2.4 + j 4.5	41 + j 52
500 MHz	2.0 + j 5.0	45 + j 54

PACKAGE MECHANICAL DATA

Ref.: Dwg. No. 12-0123 rev. A
UDCS No. 1010947

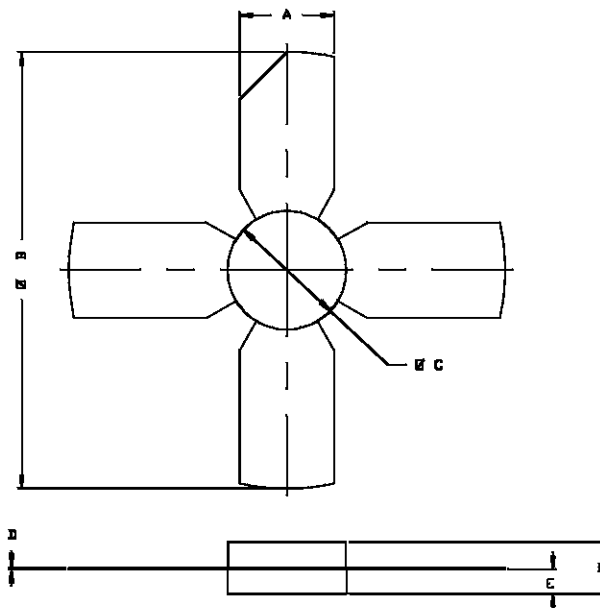

SGS-THOMSON MICROELECTRONICS		
	MINIMUM Inches/mm	MAXIMUM Inches/mm
A	.220/5.59	.230/5.84
B	-----	1.053/26.8
C	.275/6.99	.285/7.24
D	.004/0.10	.006/0.15
E	.050/1.27	.060/1.52
F	.118/3.00	.130/3.30

Information furnished is believed to be accurate and reliable. However, SGS-THOMSON Microelectronics assumes no responsibility for the consequences of use of such information nor for any infringement of patents or other rights of third parties which may result from its use. No license is granted by implication or otherwise under any patent or patent rights of SGS-THOMSON Microelectronics. Specifications mentioned in this publication are subject to change without notice. This publication supersedes and replaces all information previously supplied. SGS-THOMSON Microelectronics products are not authorized for use as critical components in life support devices or systems without express written approval of SGS-THOMSON Microelectronics.

©1996 SGS-THOMSON Microelectronics - All Rights Reserved

SGS-THOMSON Microelectronics GROUP OF COMPANIES

Australia - Brazil - France - Germany - Hong Kong - Italy - Japan - Korea - Malaysia -
Malta - Morocco - The Netherlands - Singapore - Spain - Sweden - Switzerland - Taiwan -
Thailand - United Kingdom - U.S.A.

www.DataSheet4U.com