

RF & MICROWAVE TRANSISTORS 800-960MHz BASE STATION APPLICATIONS

- 800 - 960 MHz
- 24 VOLTS
- EFFICIENCY 50%
- COMMON EMITTER
- GOLD METALLIZATION
- CLASS AB LINEAR OPERATION
- $P_{OUT} = 15 \text{ W MIN. WITH } 8.0 \text{ dB GAIN}$

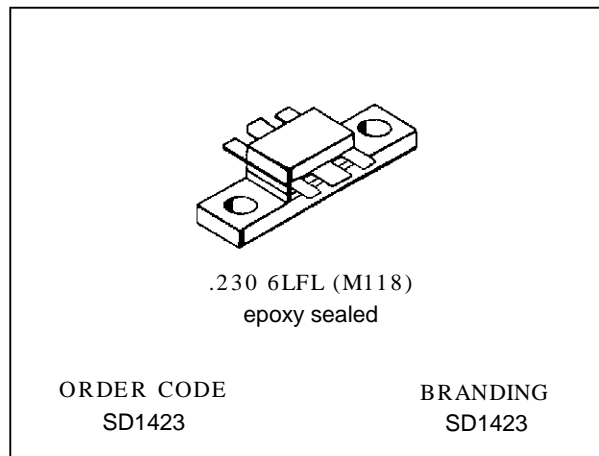

DESCRIPTION

The SD1423 is a gold metallization epitaxial silicon NPN planar transistor using diffused emitter ballast resistors for high linearity Class AB operation for cellular base station applications. The SD1423 is designed as a medium power output device or as the driver for the SD1424.

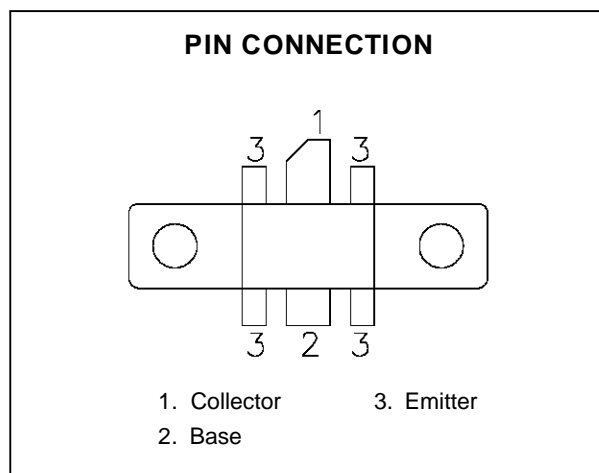

ABSOLUTE MAXIMUM RATINGS ($T_{case} = 25^{\circ}\text{C}$)

Symbol	Parameter	Value	Unit
V_{CBO}	Collector-Base Voltage	48	V
V_{CEO}	Collector-Emitter Voltage	25	V
V_{CES}	Collector-Emitter Voltage	45	V
V_{EBO}	Emitter-Base Voltage	3.5	V
I_C	Device Current	2.5	A
P_{DISS}	Power Dissipation	29	W
T_J	Junction Temperature	+200	$^{\circ}\text{C}$
T_{STG}	Storage Temperature	- 65 to +150	$^{\circ}\text{C}$

THERMAL DATA

$R_{TH(j-c)}$	Junction-Case Thermal Resistance	6	$^{\circ}\text{C/W}$
---------------	----------------------------------	---	----------------------

SD1423**ELECTRICAL SPECIFICATIONS** ($T_{\text{case}} = 25^{\circ}\text{C}$)**STATIC**

Symbol	Test Conditions		Value			Unit
			Min.	Typ.	Max.	
BV_{CBO}	$I_C = 50\text{mA}$	$I_E = 0\text{mA}$	48	50	—	V
BV_{CEO}	$I_C = 20\text{mA}$	$I_B = 0\text{mA}$	25	30	—	V
BV_{EBO}	$I_E = 5\text{mA}$	$I_C = 0\text{mA}$	3.5	4.0	—	V
I_{CBO}	$V_{CB} = 24\text{V}$	$I_E = 0\text{mA}$	—	—	1.0	mA
h_{FE}	$V_{CE} = 10\text{V}$	$I_C = 100\text{mA}$	20	—	100	—

DYNAMIC

Symbol	Test Conditions			Value			Unit
				Min.	Typ.	Max.	
P_{OUT}	$f = 960\text{ MHz}$	$V_{CC} = 24\text{ V}$	$I_{CQ} = 75\text{ mA}$	15	—	—	W
P_G	$f = 960\text{ MHz}$	$V_{CC} = 24\text{ V}$	$I_{CQ} = 75\text{ mA}$	8	—	—	dB
η_C	$f = 960\text{ MHz}$	$V_{CC} = 24\text{ V}$	$I_{CQ} = 75\text{ mA}$	45	50	—	%
C_{OB}	$f = 1\text{ MHz}$	$V_{CB} = 24\text{V}$		—	20	24	pF

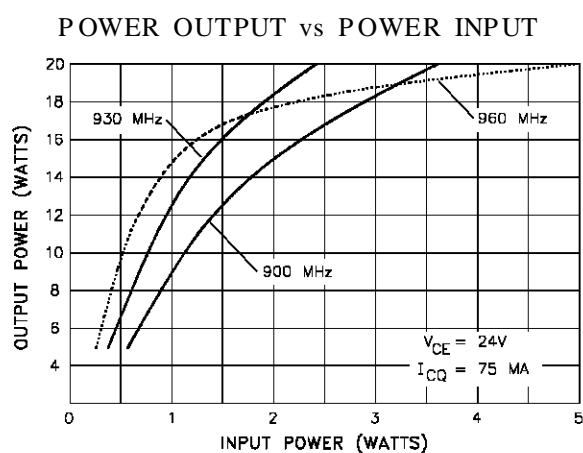
TYPICAL PERFORMANCE**IMPEDANCE DATA**

FREQ.	$Z_{IN} (\Omega)$	$Z_{CL} (\Omega)$
900 MHz	$1.30 + j 1.98$	$3.99 + j 5.55$
930 MHz	$1.42 + j 2.31$	$3.18 + j 4.97$
960 MHz	$1.45 + j 2.62$	$2.96 + j 4.07$

 $P_{OUT} = 15\text{ W}$ $V_{CE} = 75\text{ mA}$ $I_{CQ} = 24\text{ V}$

TEST CIRCUIT

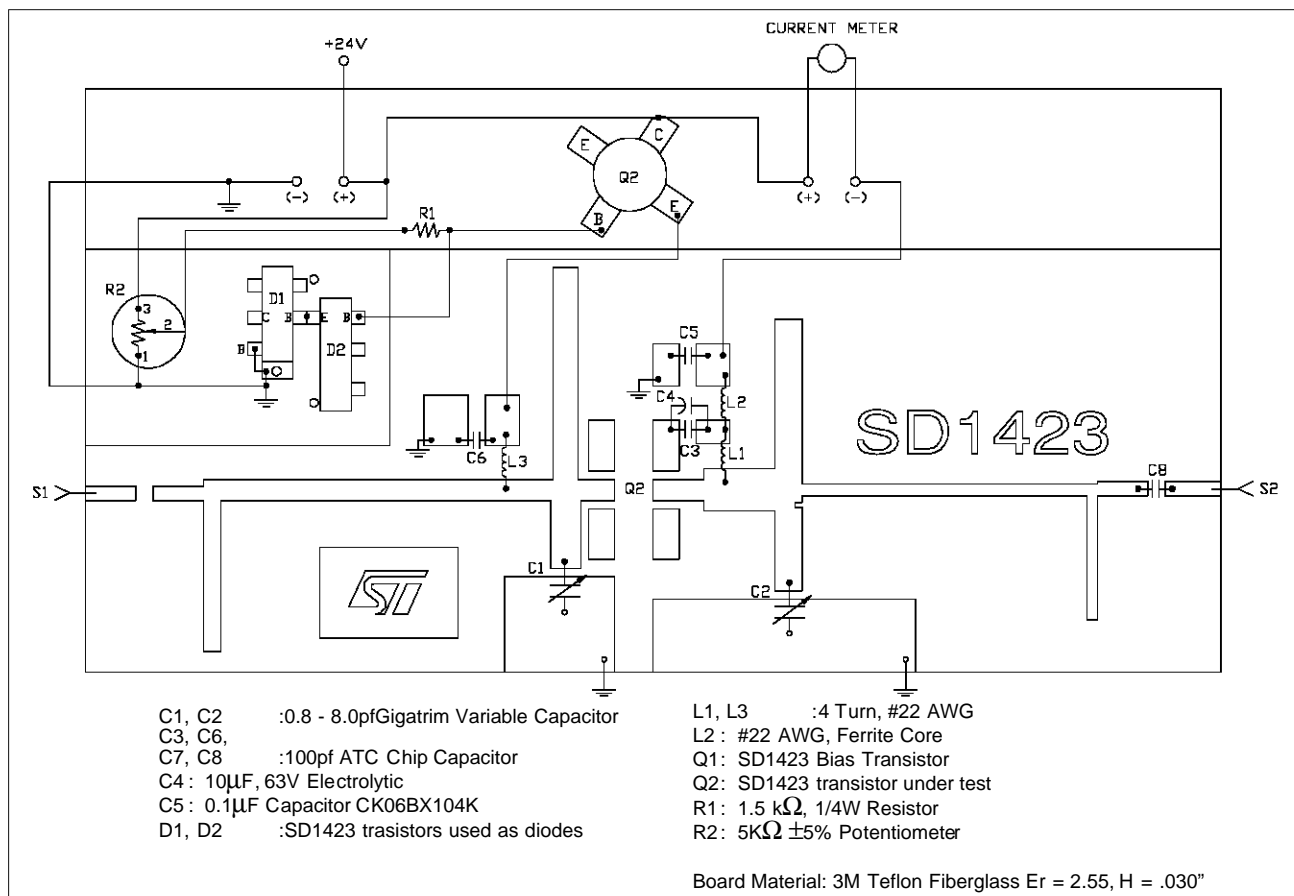

TEST CIRCUIT DIMENSIONS

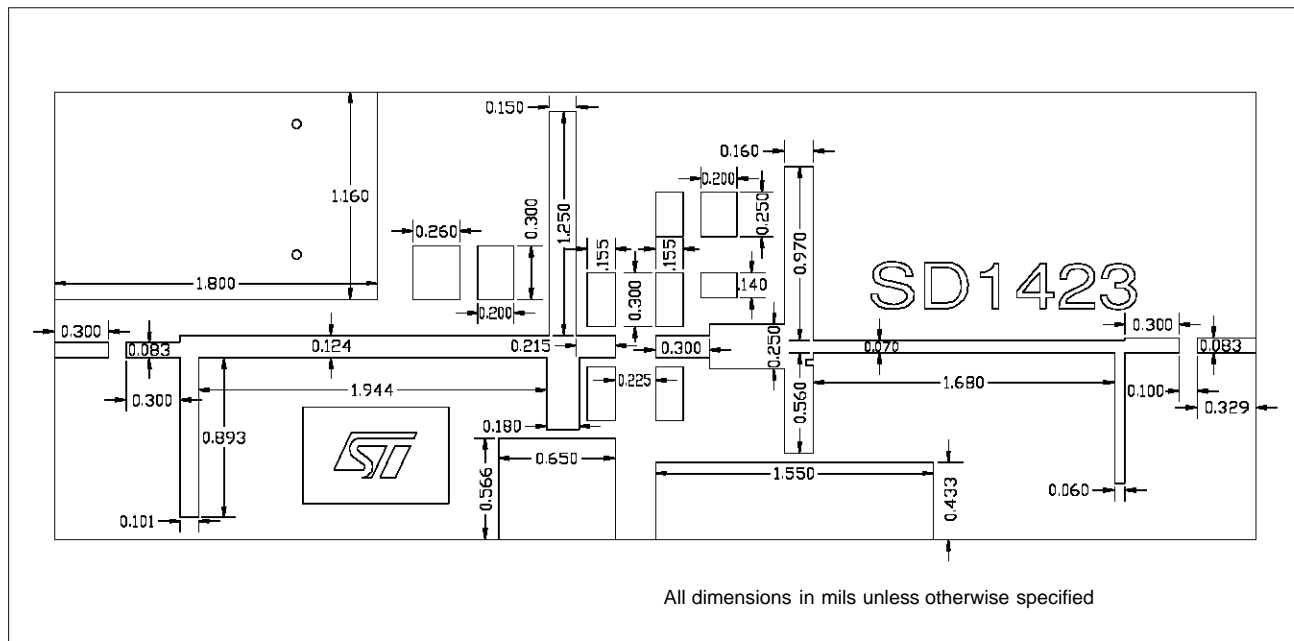

SD1423

TEST CIRCUIT LAYOUT

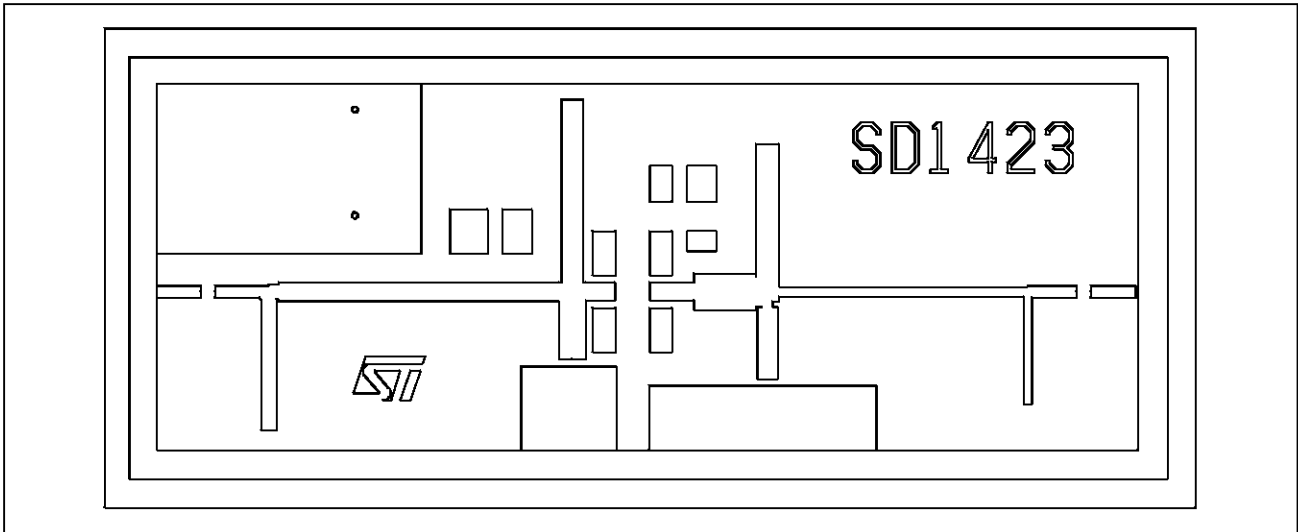

PACKAGE MECHANICAL DATA

Ref.: UDCS Doc. No.1010941 rev. B

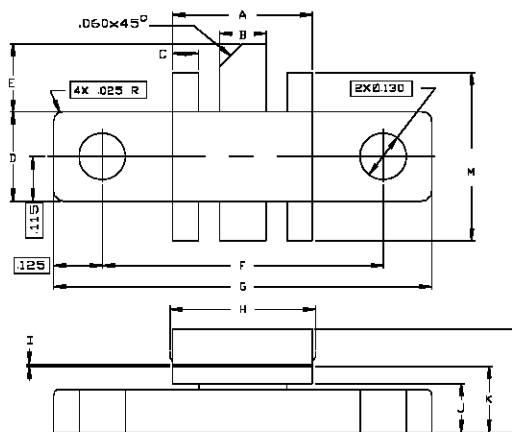

SGS-THOMSON MICROELECTRONICS		CONT'D			
	MINIMUM Inches/mm	MAXIMUM Inches/mm		MINIMUM Inches/mm	MAXIMUM Inches/mm
A	.355/9,02	.365/9,27	K	.160/4,06	.180/4,57
B	.115/2,92	.125/3,18	L	.250/6,35	.275/6,99
C	.060/1,52	.070/1,78	M	.420/10,67	.450/11,43
D	.225/5,72	.235/5,97			
E	.150/3,81	.170/4,32			
F	.720/18,29	.730/18,54			
G	.970/24,64	.980/24,89			
H	.355/9,02	.365/9,27			
I	.004/0,10	.005/0,15			
J	.120/3,05	.130/3,30			

Information furnished is believed to be accurate and reliable. However, SGS-THOMSON Microelectronics assumes no responsibility for the consequences of use of such information nor for any infringement of patents or other rights of third parties which may result from its use. No license is granted by implication or otherwise under any patent or patent rights of SGS-THOMSON Microelectronics. Specifications mentioned in this publication are subject to change without notice. This publication supersedes and replaces all information previously supplied. SGS-THOMSON Microelectronics products are not authorized for use as critical components in life support devices or systems without express written approval of SGS-THOMSON Microelectronics.

©1996 SGS-THOMSON Microelectronics - All Rights Reserved

SGS-THOMSON Microelectronics GROUP OF COMPANIES
Australia - Brazil - France - Germany - Hong Kong - Italy - Japan - Korea - Malaysia -