

SD188SBWS

SILICON SCHOTTKY BARRIER DIODE

Features

- Small surface mounting type
- Ultra low V_F
- High reliability

PINNING

PIN	DESCRIPTION
1	Cathode
2	Anode

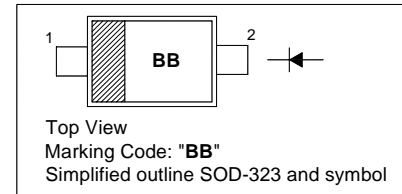

Absolute Maximum Ratings ($T_a = 25\text{ }^\circ\text{C}$)

Parameter	Symbol	Value	Unit
Peak Reverse Voltage	V_{RM}	20	V
Reverse Voltage	V_R	10	V
Mean Rectifying Current	I_O	200	mA
Peak Forward Surge Current	I_{FSM}	0.5	A
Junction Temperature	T_j	125	$^\circ\text{C}$
Storage Temperature Range	T_s	- 40 to + 125	$^\circ\text{C}$

Characteristics at $T_a = 25\text{ }^\circ\text{C}$

Parameter	Symbol	Max.	Unit
Forward Voltage at $I_F = 50\text{ mA}$ at $I_F = 200\text{ mA}$	V_F	0.3 0.41	V
Reverse Current at $V_R = 10\text{ V}$	I_R	20	μA

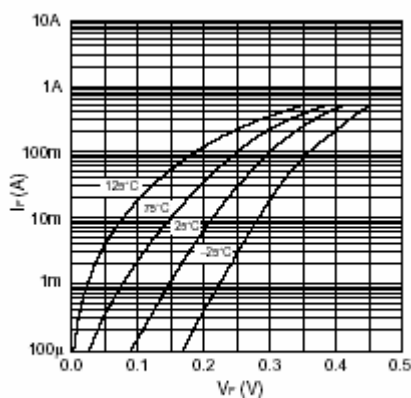

Fig.1 Forward characteristics

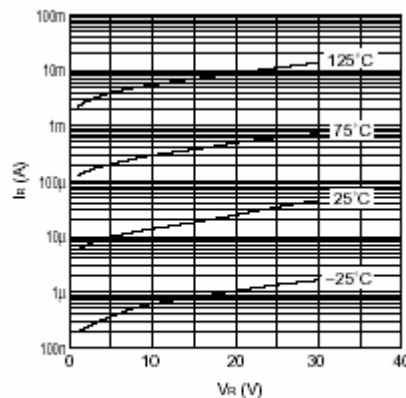

Fig.2 Reverse characteristics

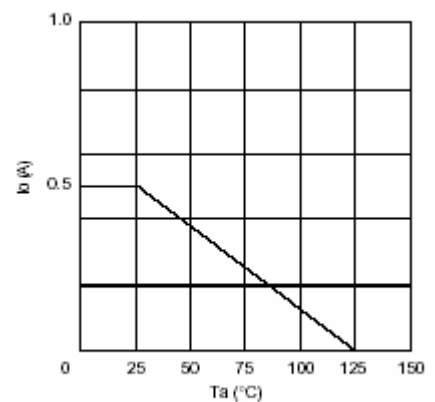
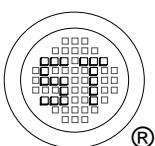

Fig.3 Derating curve



SEMTECH ELECTRONICS LTD.

(Subsidiary of Sino-Tech International Holdings Limited, a company
listed on the Hong Kong Stock Exchange, Stock Code: 724)



ISO/TS 16949 : 2002 Certificate No. 05103
ISO 14001:2004 Certificate No. 7116
ISO 9001:2000 Certificate No. 0506098

Dated : 01/09/2006

SD188SBWS

PACKAGE OUTLINE

Plastic surface mounted package; 2 leads

SOD-323

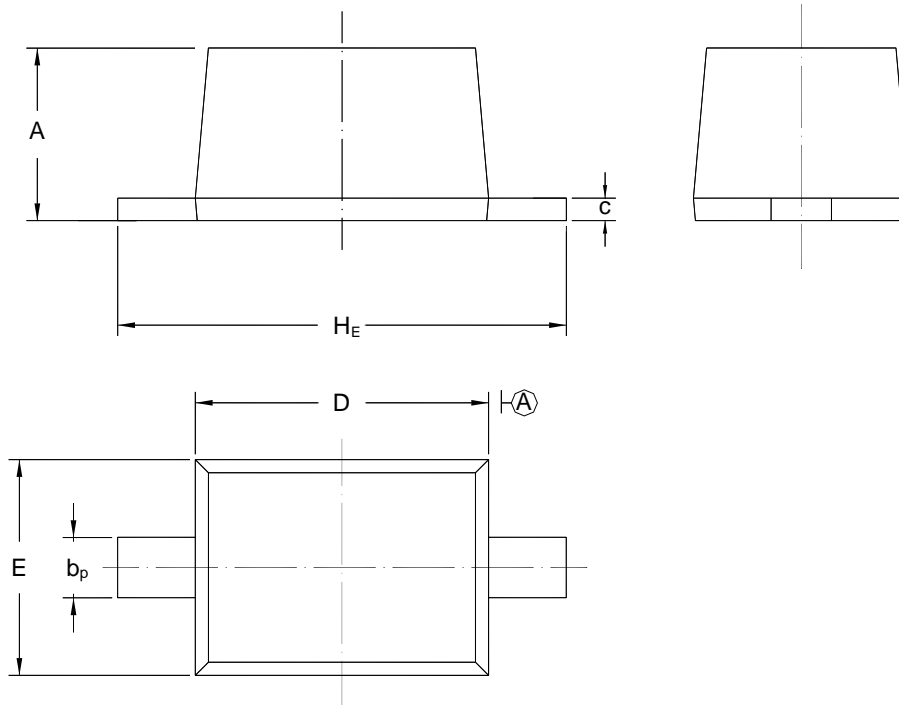

www.DataSheet4U.com

UNIT	A	b _p	C	D	E	H _E
mm	1.10 0.80	0.40 0.25	0.15 0.00	1.80 1.60	1.35 1.15	2.80 2.30

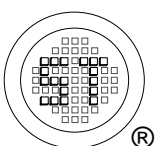

SEMTECH ELECTRONICS LTD.
 (Subsidiary of Sino-Tech International Holdings Limited, a company
 listed on the Hong Kong Stock Exchange, Stock Code: 724)



ISO/TS 16949 : 2002 Certificate No. 05103
 ISO 14001:2004 Certificate No. 7116
 ISO 9001:2000 Certificate No. 0506098

Dated : 01/09/2006