



T-31-25
SD2204

P-CHANNEL ENHANCEMENT MODE D-MOS FET

ORDERING INFORMATION

Sorted Chips in Conductive Waffle Pack	SD2204CHP
TO-226AA (TO-92) Plastic Package	SD2204BD
Description	-400V, 700Ω

FEATURES

- Ultra-Low Channel OFF Leakage, <math>< -500\text{pA}</math>
- Low Interelectrode Capacitances
- N-Channel Complements available, SD1201
- Gate Standoff Voltage, $\pm 40\text{V}$ min.

APPLICATIONS

- High-Voltage Drivers
- High-Voltage Level Translators
- Reed Relay Replacements

ABSOLUTE MAXIMUM RATINGS ($T_A = +25^\circ\text{C}$, unless otherwise specified)

Drain-Source Voltage	-400V	Continuous Drain Current	$T_A = +25^\circ\text{C}$	$T_C = +25^\circ\text{C}$
Drain-Gate Voltage	-400V		-15mA	-25mA
Gate-Source Voltage	$\pm 40\text{V}$	Continuous Device Dissipation	$T_A = +25^\circ\text{C}$	$T_C = +25^\circ\text{C}$
Operating and Storage Temperature Range	-55 to $+125^\circ\text{C}$		0.30W	1.0W
Lead Temperature (1/16" from mounting surface for 10 sec.)	$+260^\circ\text{C}$	Linear Derating Factor	$T_A = +25^\circ\text{C}$	$T_C = +25^\circ\text{C}$
			3.0mW/ $^\circ\text{C}$	10mW/ $^\circ\text{C}$

PIN CONFIGURATION

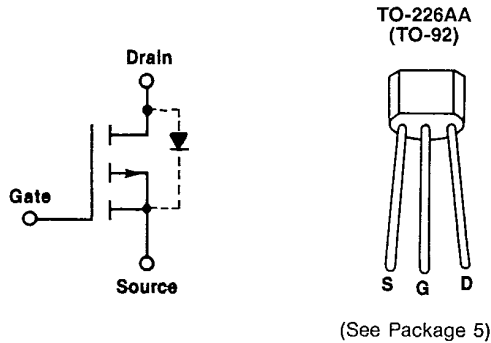

CHIP CONFIGURATION

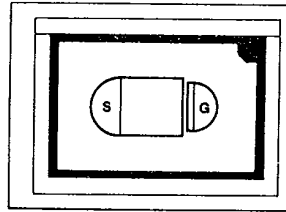

Dimensions: .025 x .035 x .020 in.
Drain is backside contact.

ELECTRICAL CHARACTERISTICS ($T_A = +25^\circ\text{C}$ per channel, unless otherwise noted)

#	CHARACTERISTIC	MIN	TYP	MAX	UNIT	TEST CONDITIONS
1	BV_{DSS} Drain-Source Breakdown Voltage	-400			V	$I_D = -100\mu\text{A}$, $V_{GS} = 0$
2		-400				$I_D = -1.0\mu\text{A}$
3	I_{DSS} Drain-Source OFF Leakage Current		-80	-500	pA	$V_{DS} = -100\text{V}$, $V_{GS} = 0$
4	I_{GBS} Gate-Body Leakage Current		± 1.0		nA	$V_{GS} = \pm 20\text{V}$, $V_{DS} = 0$
5	$V_{GS(th)}$ Gate-Source Threshold Voltage	-2.0		-5.0	V	$V_{DS} = V_{GS}$, $I_D = -0.5\text{mA}$
7	$r_{D(on)}$ Drain-Source ON Resistance		500	700	ohms	$I_D = -10\text{mA}$, $V_{GS} = -10\text{V}$
8	$I_{D(on)}$ Drain-Source ON Current	-15	-40		mA	$V_{DS} = -25\text{V}$, $V_{GS} = -10\text{V}$
9	g_{fs} Common-Source Forward Transconductance	3.0	7.5		mmhos	$V_{DS} = -25\text{V}$, $I_D = -5\text{mA}$, $f = 1\text{KHz}$
10	C_{iss} Common-Source Input Capacitance		8.0	10	pF	$V_{DS} = -25\text{V}$, $V_{GS} = 0$, $f = 1\text{MHz}$
11	C_{oss} Common-Source Output Capacitance		1.5	2.0		
12	Common-Source Reverse Transfer Capacitance		0.8	1.0		
13	$t_{d(on)}$ Turn-ON Delay Time		6		nS	$V_{DD} = -25\text{V}$, $V_{G(on)} = -10\text{V}$, $R_L = 500\Omega$, $R_G = 51\Omega$
14	t_r Rise time		6			
15	$t_{d(off)}$ Turn-OFF Delay Time		8			
16	t_f Fall Time		6			

SWITCHING TIME TEST CIRCUIT

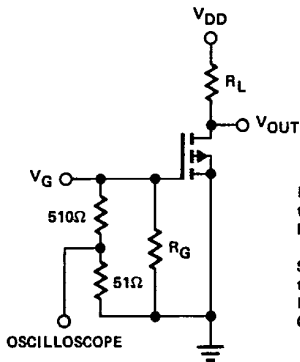

INPUT PULSE
 $t_r < 0.5 \text{ nSEC}$
 PULSE WIDTH - 100 nSEC

SAMPLING OSCILLOSCOPE
 $t_r < 0.38 \text{ nSEC}$
 $R_{in} > 1 \text{ M}\Omega$
 $C_{in} < 2.0 \text{ pF}$

TEST WAVEFORMS

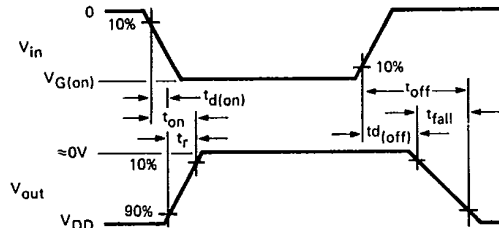

TYPICAL PERFORMANCE CHARACTERISTICS ($T_A = +25^\circ\text{C}$ per channel, unless otherwise noted)

DRAIN-SOURCE ON RESISTANCE
—VS—
GATE-SOURCE VOLTAGE

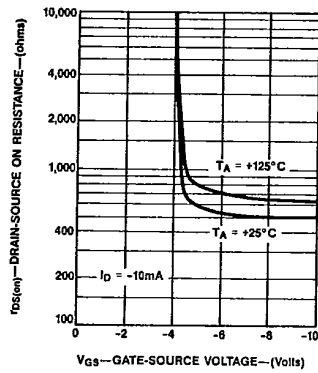

ON DRAIN CURRENT
—VS—
GATE-SOURCE VOLTAGE

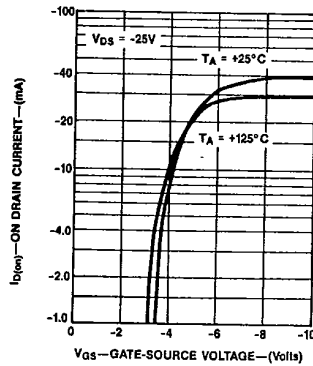

DRAIN-SOURCE OFF LEAKAGE CURRENT
—VS—
AMBIENT TEMPERATURE

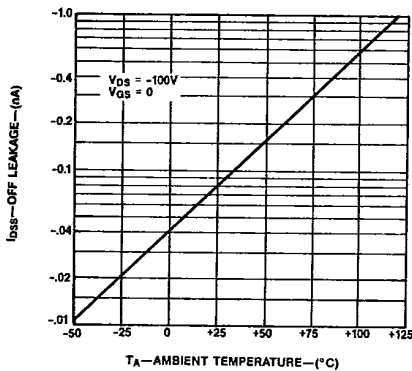

FORWARD TRANSCONDUCTANCE
—VS—
ON DRAIN CURRENT

