

SD306 Fan Controller

Features

- Use 455 KHz crystal time base.
- Three wind modes : Constant wind, Rhythmical wind, Sleep wind.
- Three wind grades : Soft wind, Medium wind, Strong wind.
- Six types of timing function selection by bonding options.
- Key-in protection function.
- Power supply range : 4.0V ~6.0V.
- Low power consumption.

General Description

SD306 is a new type of fan controller designed for wide applications. Three wind modes and three wind grades are available. In rhythmical wind mode, the wind speed is programmable. In sleep wind mode, the wind speed

is automatically decreasing to help fall asleep. There are six types of fan controller provide more flexible timing selection for user (by bonding option BO1, BO2 and BO3).

Type	Timer	BO1	BO2	BO3
SD306-A	0.5→1→2→4 , summable	F	F	VSS
SD306-B	0.5→1→2→4 , non-summable	F	F	F
SD306-C	1→2→4→8 , summable	F	VDD	VSS
SD306-D	1→2→4→8 , non-summable	F	VDD	F
SD306-E	1→2→4 , summable	VDD	F	VSS
SD306-F	1→2→4 , non-summable	VDD	F	F

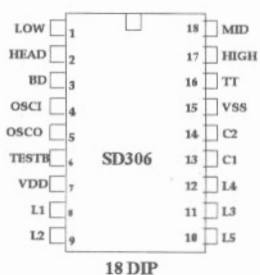
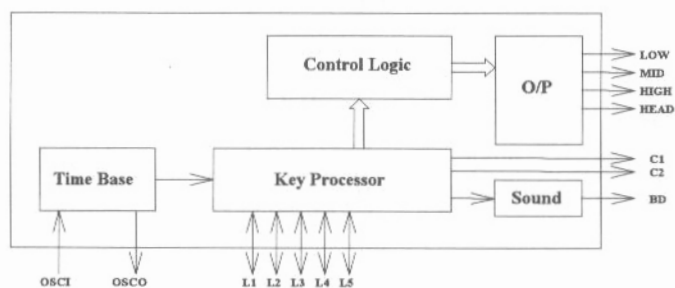
Pin Configuration

SD 306 Block Diagram

Pin Description

Pin No.	Symbol	Description
1	LOW	Soft wind output (driving TRIAC).
2	HEAD	Swing head control output (driving TRIAC).
3	BD	Buzzer output.
4	OSCI	455k Hz crystal oscillator input.
5	OSCO	455k Hz crystal oscillator output.
6	TESTB	Test pin.
7	VDD	Positive power supply.
8	L1	Wind speed selector and LED output.
9	L2	Enable swing head and LED output.
10	L5	Chip disable and LED output.
11	L3	Timer setting and LED output.
12	L4	Wind mode selector and LED output.
13	C1	LED pattern common pin 1.
14	C2	LED pattern common pin 2.
15	VSS	Negative power supply.
16	TT	Test pin.
17	HIGH	Strong wind output (driving TRIAC).
18	MID	Medium wind output (driving TRIAC).

Absolute Maximum Ratings

RATING	VALUE
DC Supply Voltage	< 6.5 V
Input/Output Voltage	VSS-0.5V to VDD+0.5V
Operating Temperature	-10° C to 60° C
Storage Temperature	-25° C to 125° C

Notice: Stress greater than those listed under **Absolute Maximum Ratings** may cause permanent damage to the device. This is a stress rating only and functional operation of the device at these or any other conditions above those indicated in the operational sections of this specification is not implied, Exposure to absolute maximum rating conditions for extended period may affect reliability.

Electrical Characteristics

(VDD = 4.5V, VSS = 0V, Ta = 25°C, unless otherwise specified)

Parameter	Symbol	Min.	Typ.	Max.	Condition
Operating Voltage	Vdd	4.0V	4.5V	6.0V	
Current On TRIAC Driver Pin	ITRIAC	---	10mA	---	Vout = 3V
Current On LED Driver Pin	Idriving	---	6mA	---	Vout = 3V
Current On C1, C2 Pin	Isinking	---	33mA	---	Vout = 1.5V
Current On BD Pin	Idriving & Isinking	---	2mA	---	Vout = 3V(Drv.)/1.5V(Sink)
Crystal Oscillator Frequency	Freq.	---	455KHz	---	

Operation Function

SD306 has five control inputs : Turn off, Wind speed, Wind mode, Timer setting, Head swing. The control signal can be input by the keypads. When the control signals besides "Turn off" are received, the control system echoes an "Bi" voice. If any two keys or more are simultaneously pressed, neither of the corresponding functions will be activated. If any key is kept on

depressing over 6 seconds, the fan controller will automatically echo four warning "Bi"s and power off. The "Speed" starts the fan, then the speed is at "Soft wind". Pushing "Speed" key, the sequence of the wind speed is "Soft → Medium → Strong". The sequence of the "Mode" is "Constant → Rhythmical → Sleep". Detailed function graph is shown below.

Function Graph

- Rhythmical Wind mode programmed with speed : ($t = 6\text{sec}$)

Strong-Rhythmical Wind

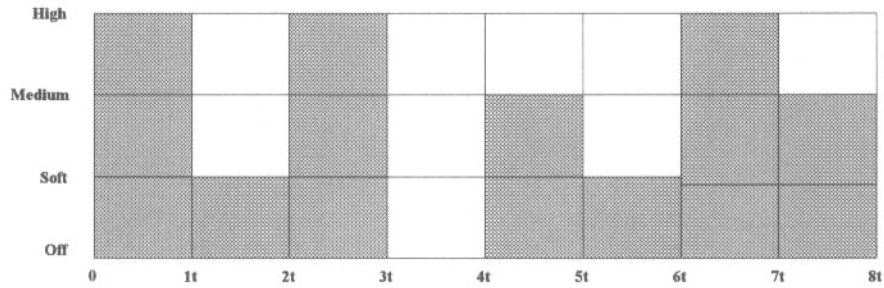

Medium-Rhythmical Wind

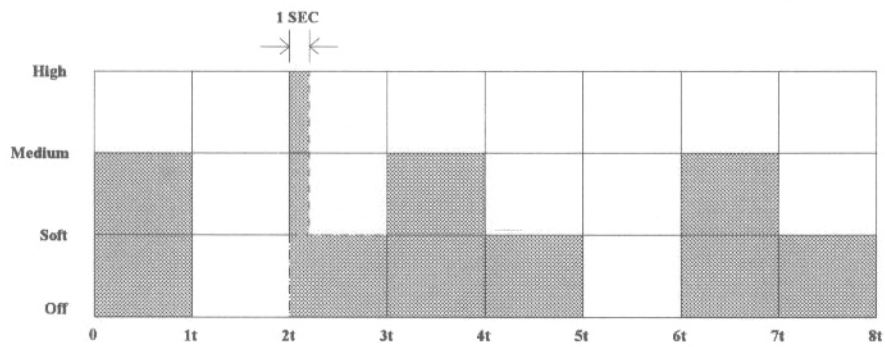

Soft-Rhythmical Wind

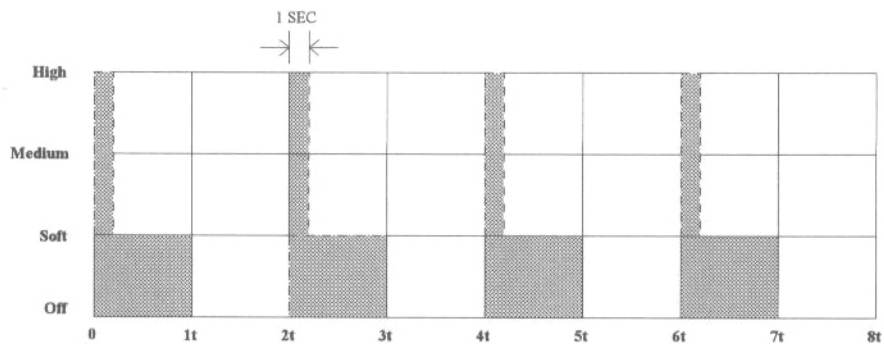

• Sleep Wind: (T = 0.5hr)

Strong-Sleep Wind

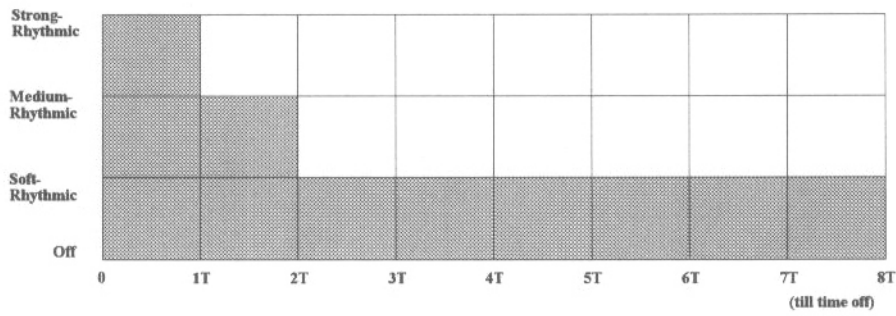

Medium-Sleep Wind

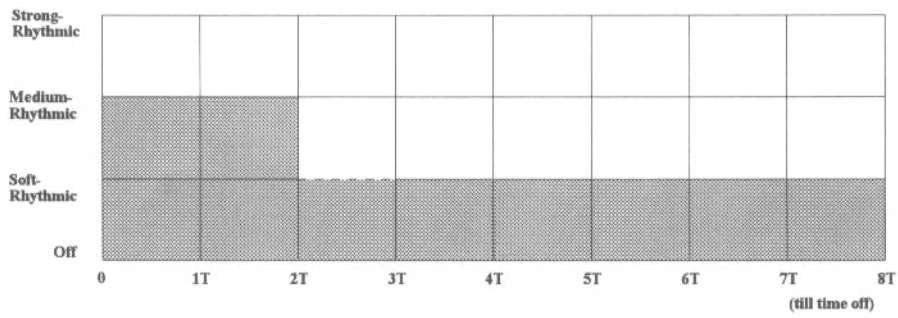

Soft-Sleep Wind

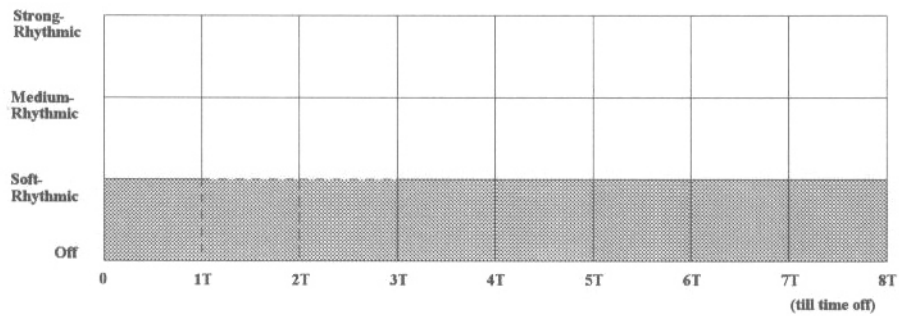

Application Circuit

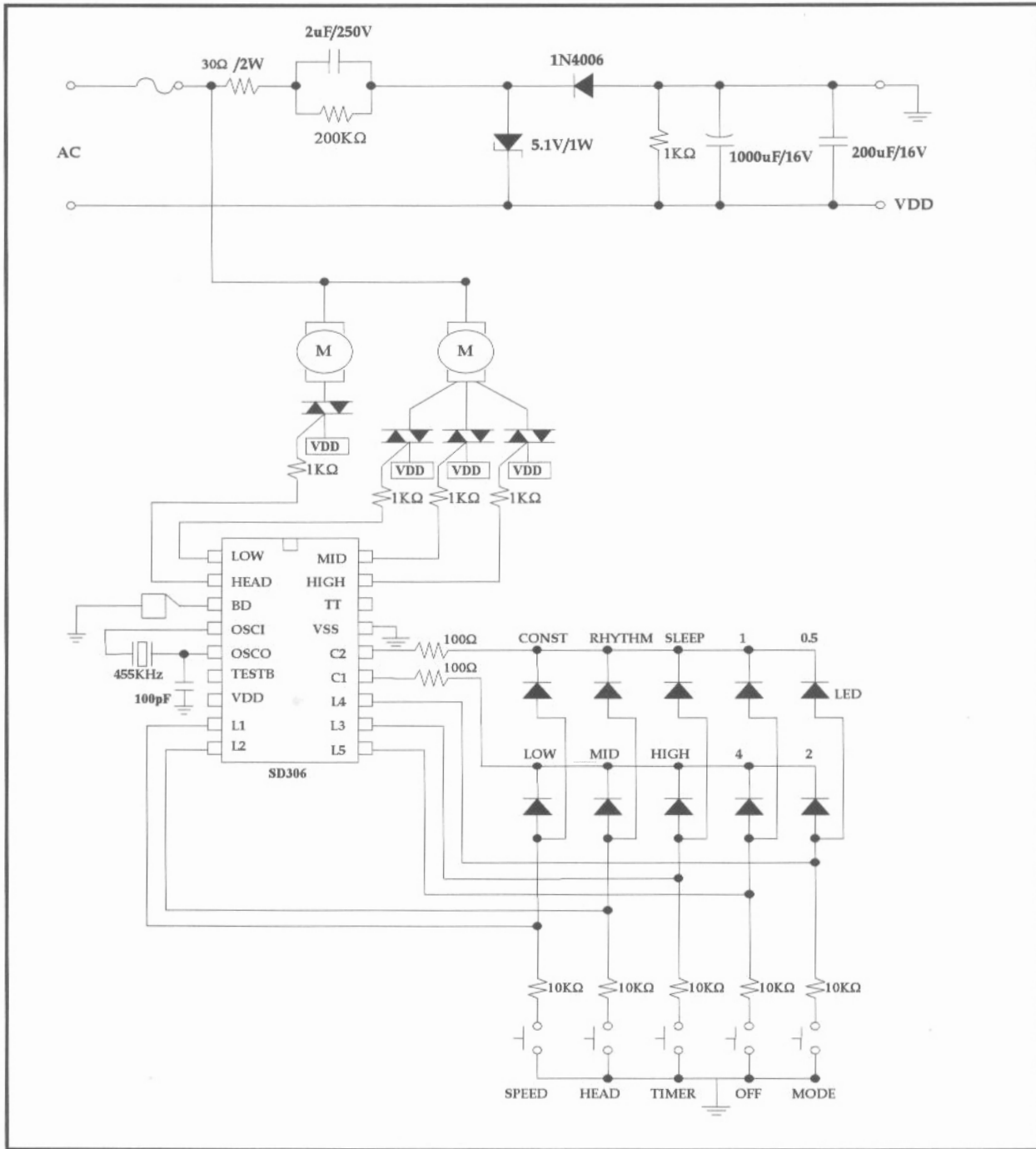

Fig 1. SD306 Typical Application Circuit.

Bonding Diagram
