

## Schottky Barrier Rectifier Diode

## Features

- Fast Switching
- Low forward voltage drop,  $V_F$
- Guard ring protection
- High surge capacity
- High efficiency, low power loss

Electrical Ratings ( $T_C = 25^\circ\text{C}$ , unless otherwise noted)

Parameter	Symbol	Values	Units
Repetitive peak reverse voltage	$V_{RRM}$	45	V
DC blocking voltage	$V_{DC}$		
Non-repetitive peak reverse voltage	$V_{RSM}$	54	V
Average rectified forward current ( $T_C = 85^\circ\text{C}$ )	$I_{F(AV)}$	60	A
Non-repetitive peak surge current (surge applied at rated load conditions, halfwave, single phase, 60 Hz)	$I_{FSM}$	600	A



DO-203AB (DO-5)

Maximum Ratings ( $T_C = 25^\circ\text{C}$ , unless otherwise noted)

Parameter	Test Conditions	Symbol	Values	Units
Maximum instantaneous forward voltage	$I_F = 30\text{ A}$	$V_F$	0.58	V
	$I_F = 60\text{ A}$		0.66	V
	$I_F = 120\text{ A}$		0.86	V
Maximum instantaneous reverse current at rated DC voltage	$T_C = 25^\circ\text{C}$	$I_R$	50	mA
	$T_C = 125^\circ\text{C}$		125	mA

Thermal & Mechanical Specifications ( $T_E = 25^\circ\text{C}$ , unless otherwise noted)

Parameters	Symbol	Values	Units
Maximum thermal resistance, junction to case	$R_{th(jc)}$	1.0	$^\circ\text{C}/\text{W}$
Operating junction temperature range	$T_J$	-65 to +150	$^\circ\text{C}$
Storage temperature	$T_{stg}$	-65 to +150	$^\circ\text{C}$
Mounting torque (non-lubricated threads)		15	in-lb
Approximate allowable weight	W	45.6	g

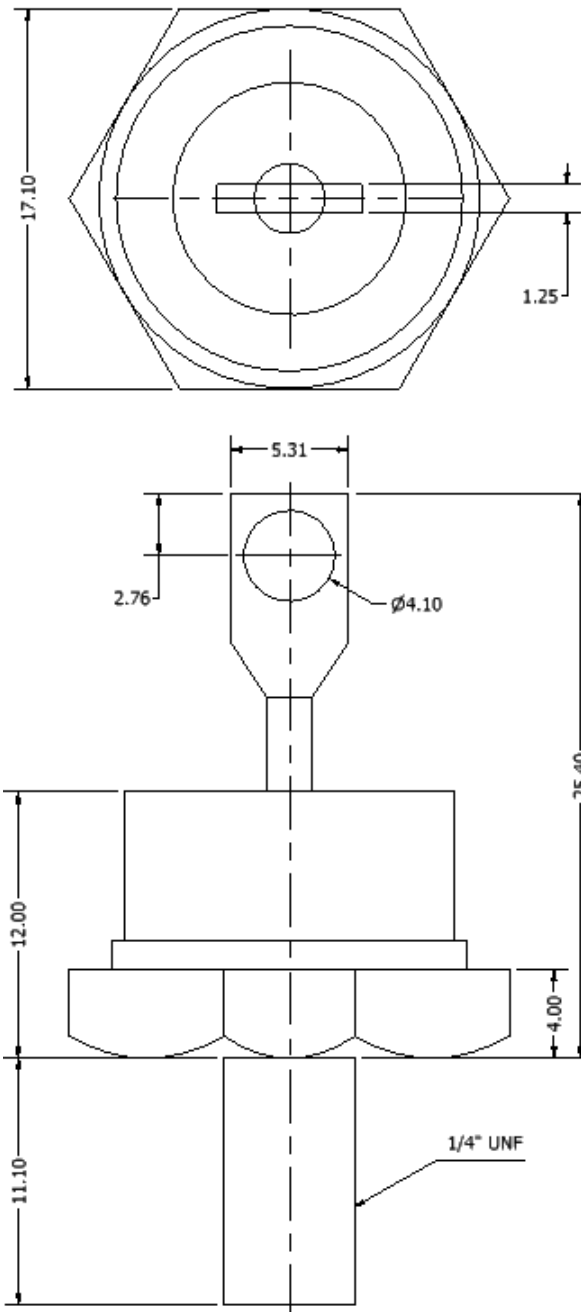

ALL DIMENSIONS IN MM