

The SDA 2008 IC represents a follow-on development of the infrared transmitter IC SAB 3210. It includes a disconnectable 8-stage divider, thus enabling the oscillator to operate up to 500 kHz with a ceramic oscillator instead of an LC circuit.

Features

- Complete security of the keyboard against operating errors
- Instruction extension up to 60 instructions is possible by using diodes and by means of a shift key (keyboard changeover)
- Start bit programmable by external voltage
- Wide supply voltage range between 5 V and 16 V
- Low current consumption, typically 3 mA. The battery can be switched off by an external transistor
- No external column resistors necessary

Maximum ratings

all voltages referred to $V_{DD} = 0$ V

Supply voltage	V_{SS}	18	V
Input voltage	V_i	18	V
Power dissipation per output	P_q	100	mW
Total power dissipation	P_{tot}	500	mW
Storage temperature range	T_{stg}	-40 to 125	°C

Operating range

referred to $V_{DD} = 0$ V

Supply voltage	V_{SS1}	5 to 16	V
Supply voltage ¹⁾	V_{SS1}	5.5 to 16	V
Ambient temperature	T_A	0 to 70	°C

¹⁾ Instruction extension with diodes

Characteristicsall voltages referred to V_{DD}

	min	typ	max	
Supply current (outputs not connected)		3	7	mA
Leakage current, total current of outputs Ca, Cb, Cc, Cd, ETA, IRA (refer to test circuit)			1	μ A

Inputs**Oscillator input CLK I**Operating frequency
with prescaler

f_{17}	160		560	kHz
----------	-----	--	-----	-----

Operating frequency for external clock
with disconnected prescaler

f_{17}	20		70	kHz
----------	----	--	----	-----

IRA remote control signal outputH output voltage
(refer to test circuit)

V_{qH8}	$V_{SS}-5$			V
-----------	------------	--	--	---

 $I = 4$ mA; $V_{SS} = 6$ VH resistor with respect to V_{SS}

R_{qH8}	100			Ω
-----------	-----	--	--	----------

ETA switch-on transistor output

H output current

I_{qH7}	100		10000	μ A
-----------	-----	--	-------	---------

 $V_{q7} = V_{SS} - 4$ V

Row input 1 to 8 (internal pull-high resistors)

Instructions can be transmitted by connecting the respective row input with the corresponding column output (refer to instruction set). Operating errors, such as connecting more than one respective row and column are recognized and transmission is interrupted. Only exception: instruction extension with row 8 (see input, keyboard).

The connection can include as max. resistance a silicon diode junction in forward direction and a $100\ \Omega$ resistance in series. Minimum resistance is zero.

ETA input

The ETA input is connected to the supply voltage via the base-emitter diode of the NPN switching transistor for normal transmitting operations.

PPIN program input

If the PPIN input is joined with the corresponding column output or with the IRA output (in this case $= 33\ \text{k}\Omega \leq R_{\text{IRA}} \leq 47\ \text{k}\Omega$) the output mode can be changed in accordance with the table "PPIN connections".

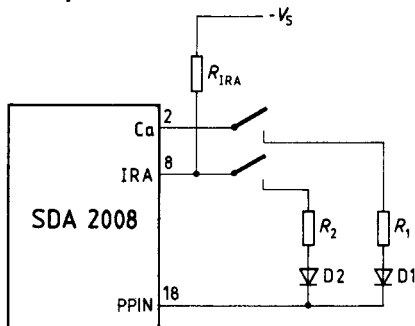
Example

$$33\ \text{k}\Omega \leq R_{\text{IRA}} \leq 47\ \text{k}\Omega$$

$$R_1 R_2 \leq 100\ \Omega$$

$$D1, D2 = V_1 \leq 0.8\ \text{V at } I_F = 0.1\ \text{mA} \\ \text{and } T_{A\ \text{min}}$$

Description of function

The SDA 2008 IC operates as a transmitter for the infrared remote control system IR 60. The PMOS circuit contains a control output for an NPN transistor which deactivates the supply voltage if the keyboard is not activated (i.e. no row is in "low" state).

Input, keyboard

The transmitter contains an input matrix of 8 rows and 4 columns. In order to input an instruction, a row must be connected to a column. Thus, the transmitter is switched on and the appropriate instruction is sent. Without further measures it is possible to issue up to 32 instructions. The instruction set can be extended up to 60 either with the aid of additional diodes (for this purpose 2 diodes are required for each 4 additional instructions) or up to 62 instructions with a shift key. In both cases the additional connection (diodes to row 8 or shift key) is necessary prior to issuing the first instruction – after that the originally allocated instruction is sent independent of the additional connection.

As a fifth matrix column, – V_S can be used to input the instructions 40 to 47 (without external diode connection using only one key, each).

Operating error

The circuit includes a security lock against multi-operations (several keys are depressed simultaneously). An exception is the double operation inside a column with one of the rows 1 to 7 and row 8, since this combination is used in order to extend the instruction set with the aid of diodes. After transmission of the first infrared instruction after the startbit, this double operation is locked as well.

Start instruction, end instruction

After the switch-on, the instruction No. 62 is issued as start instruction thus indicating to the receiver the start of the instruction transmission.

In case of an operating error, this instruction is generated by the security lock. If the key or keys are released, the selected instruction is sent once more (depending upon the exact instant of release) while the instruction No. 62 is sent once as stop before the supply voltage is switched off. Safety measures prevent to change an instruction to any other than instruction No. 62.

Output

The transmitter encodes the input in bi-phase code (refer to timing diagram). Prior to the 6 information bits, a presignal and a startbit which can be selected via PPIN, are sent. The presignal enables proper control of the preamplifier on the receiver side, whereas the startbit is used for receiver discrimination. Thus it is possible to control a TV set and a radio in one room independently of each other with the same remote control system.

The output signal is carried at $1/16$ of the clock frequency ($f_{CLK}/16$) and a pulse duty factor of 1:4. With the help of corresponding wiring of the program input PPIN, the carrier can be switched off. Thus any other external carrier can be used. www.DataSheet4U.com

Instruction interval

The interval between two given instructions (except the start instruction) is approximately 12 times the instruction length (incl. presignal) or 35 536 CLKI clocks, respectively. This interval can be reduced to 30 976 CLKI clocks in order to obtain diminished instruction intervals at lower clock frequencies.

Operation at low clock frequency

The prescaler (divide by 8) can be switched off. Thus, operation is possible at a clock frequency of approx. 500 kHz or 62.5 kHz, as required. The prescaler can only be switched off if – at low resistance – the IRA output is not forced to low (by means of a base-emitter space), e.g. in the case of wiring for front-end control.

Operation without switching transistor

During operations with a fixed supply voltage ($\text{ETA} = \text{low}$), the columns a to d are periodically interrogated (H pulse) in the normal sequence (as if an instruction is emitted) in order to permit an external synchronization.

After the supply voltage began to rise at 0 V, the flow of control is brought into a definite state and starts column interrogation. After having recognized a row in the "low" state, the flow of control is reset – then the flow corresponds until disconnection to the flow present during battery operations. After transmission has ended, the flow of control continues column interrogation, however, without any further output to IRA.

Multitransmitter operation

Without great increase in external circuitry, it is possible to cascade two SDA 2008 ICs so that they can be multiplexed to give out the instructions. For this purpose, the automatic resetting of the flow control and the instruction register are utilized which become effective as soon as both columns a and b are on high.

PPIN connections

Connect with:	Function
Column a	Shift into second instruction group (bit F = "1")
Column b	Shortened instruction interval
Column c	Startbit = "0"
Column d	No carrier of the IRA signal
IRA	Bridging the prescaler

(In the case of combinations of these functions, decoupling with diodes according to figure PPIN connection is necessary).

ETA connection

ETA = V_{DD}	Operation at constant supply voltage. If no row is set to "low", IRA is without output, however permanent column interrogation.
ETA to base of the voltage commutation transistor	Normal battery operation including disconnection of the supply voltage after the end instruction at open row combination.

Instruction set

No diodes at row 8
unshifted

Instr. No.	Code		Key
	FED	CBA	
0	000	000	1a
1	000	001	1b
2	000	010	1c
3	000	011	1d
4	000	100	2a
5	000	101	2b
6	000	110	2c
7	000	111	2d
8	001	000	3a
9	001	001	3b
10	001	010	3c
11	001	011	3d
12	001	100	4a
13	001	101	4b
14	001	110	4c
15	001	111	4d
16	010	000	5a
17	010	001	5b
18	010	010	5c
19	010	011	5d
20	010	100	6a
21	010	101	6b
22	010	110	6c
23	010	111	6d
24	011	000	7a
25	011	001	7b
26	011	010	7c
27	011	011	7d
28	011	100	8a
29	011	101	8b
30	011	110	8c
31	011	111	8d

No diodes at row 8
shifted

Instr. No.	Code		Key
	FED	CBA	
32	100	000	
33	100	001	
34	100	010	
35	100	011	
36	100	100	
37	100	101	
38	100	110	
39	100	111	
40	101	000	
41	101	001	
42	101	010	
43	101	011	
44	101	100	
45	101	101	
46	101	110	
47	101	111	
48	110	000	
49	110	001	
50	110	010	
51	110	011	
52	110	100	
53	110	101	
54	110	110	
55	110	111	
56	111	000	
57	111	001	
58	111	010	
59	111	011	
60	111	100	
61	111	101	
62	111	110	
62	111	110	end instructions

With diodes at row 8
unshifted/shifted

Instr. No.	Code		Key
	FED	CBA	
32	100	000	81a
33	100	001	81b
34	100	010	81c
35	100	011	81d
36	100	100	82a
37	100	101	82b
38	100	110	82c
39	100	111	82d
40	101	000	83a
41	101	001	83b
42	101	010	83c
43	101	011	83d
44	101	100	84a
45	101	101	84b
46	101	110	84c
47	101	111	84d
48	110	000	85a
49	110	001	85b
50	110	010	85c
51	110	011	85d
52	110	100	86a
53	110	101	86b
54	110	110	86c
55	110	111	86d
56	111	000	87a
57	111	001	87b
58	111	010	87c
59	111	011	87d

Special group
unshifted/shifted

Instr. No.	Code		Key
	FED	CBA	
40	101	000	1L
41	101	001	2L
42	101	010	3L
43	101	011	4L
44	101	100	5L
45	101	101	6L
46	101	110	7L
47	101	111	8L

Instruction interval (prescaler switched on)

Interval	Interval in CLKI clocks	Interval in ms $f_{CLKI} = 500 \text{ kHz}$	PPIN connected to column b
Normal	65536	approx. 131	_____
Reduced	30976	approx. 62	X

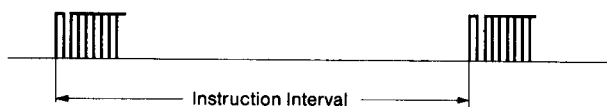
Definition of the instruction interval**Hints for special functions**

	IR remote control TV/radio sets	Front-end operation TV/radio sets	Transmission via AF cable	Remote control for model rail way	Typewriter keyboard	Time programmable remote control	TV games	Light switch remote control
Start bit changeover	X	X	X	X	X	X	X	
Shift into second group	X	X	X	X		X	X	
Diode matrix	X	X	X	X	X	X	X	
Special instruction group	X	X	X	X	X	X	X	
No carrier		X	X		X			
Bridged prescaler		X						
Shortened instruction interval			X	X				
No debounce delay								X
Special connection			X		X			

Pin description

Pin	Function
1	V_{SS} , +supply voltage
2	Column a
3	Column b
4	Column c
5	Column d
6	V_{DD} , -supply voltage
7	ETA (switch-on transistor output)
8	IRA (infrared output)
9	Row 1
10	Row 2
11	Row 3
12	Row 4
13	Row 5
14	Row 6
15	Row 7
16	Row 8
17	CLKI (oscillator input)
18	PPIN (programming input)

Oscillator connection

1)

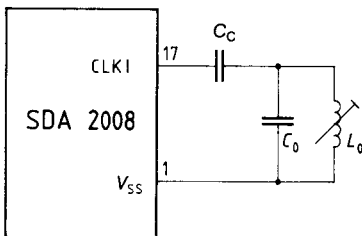

$$C_C \geq 10\text{nF} \quad f_{\text{CLKI}} \approx \frac{1}{2\pi\sqrt{L_0 C_0}}$$

2)

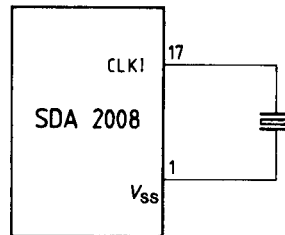

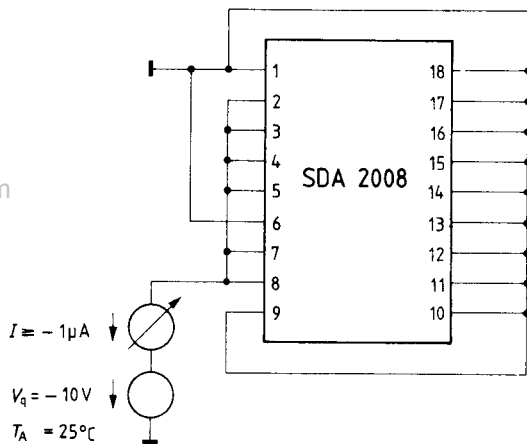
Leakage current, total current (test circuit)

DataSheet4U.com

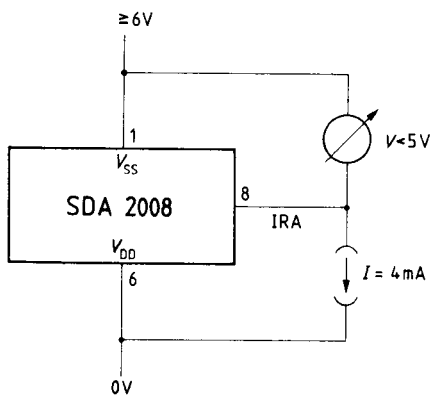
IRA remote control signal output (test circuit)

Biphase coding from instruction 011001

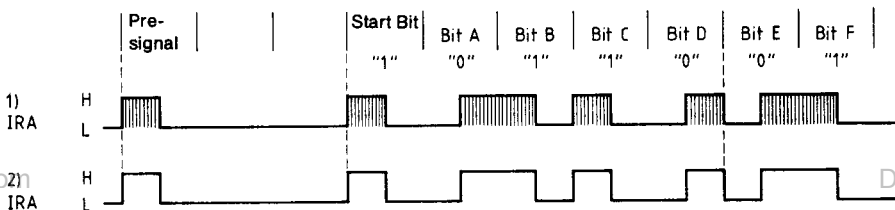

Def: for "0" and "1"

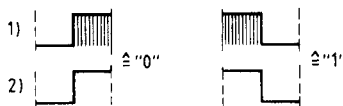
1) with Carrier
2) without Carrier

Exact Pulse Train of a Burst for 1):

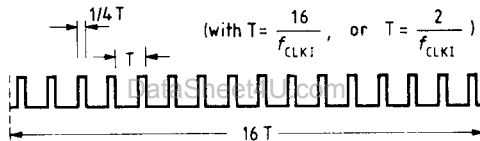

Actuating a key (e.g. 1a), $f_{CLKI} = 500 \text{ kHz}$

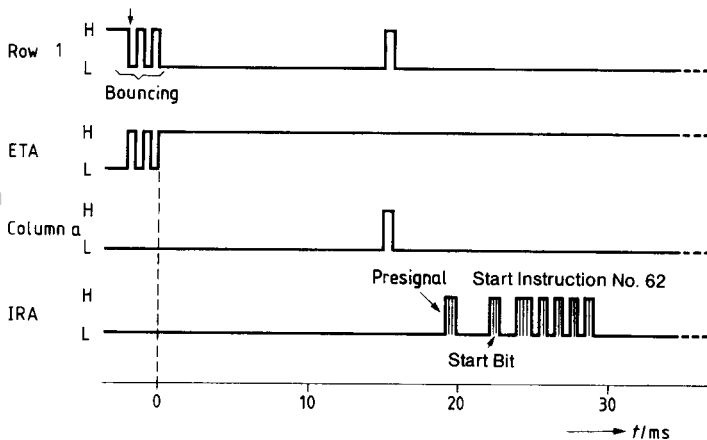

DataSheet4U.com

Releasing a key (1a), $f_{CLKI} = 500 \text{ kHz}$

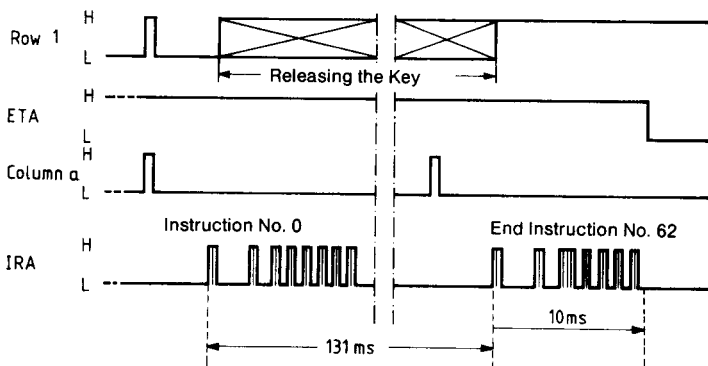

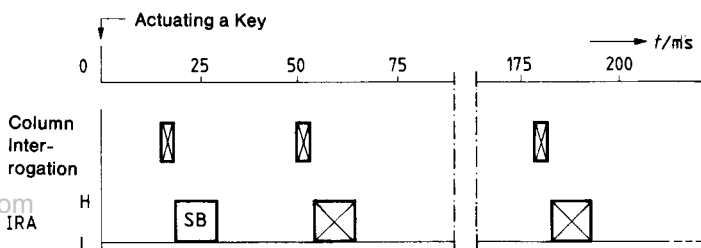
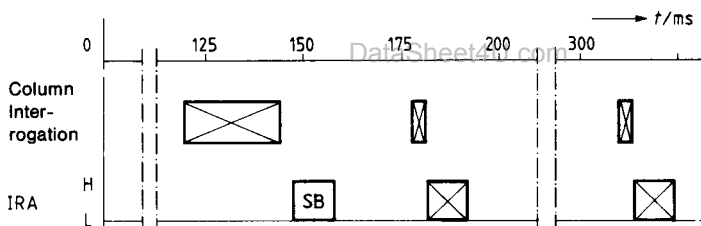
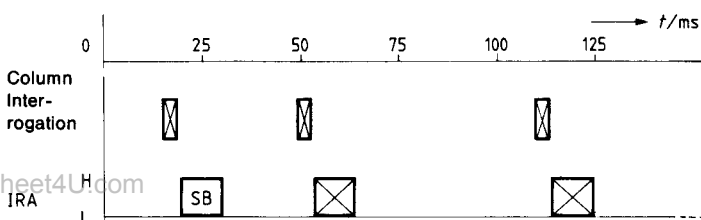
Instruction interval, $f_{CLKI} = 500 \text{ kHz}$

PPIN at IRA (bridged prescaler) $f_{CLKI} = 62.5 \text{ kHz}$

PPIN at column b (shortened instruction interval) $f_{CLKI} = 500 \text{ kHz}$

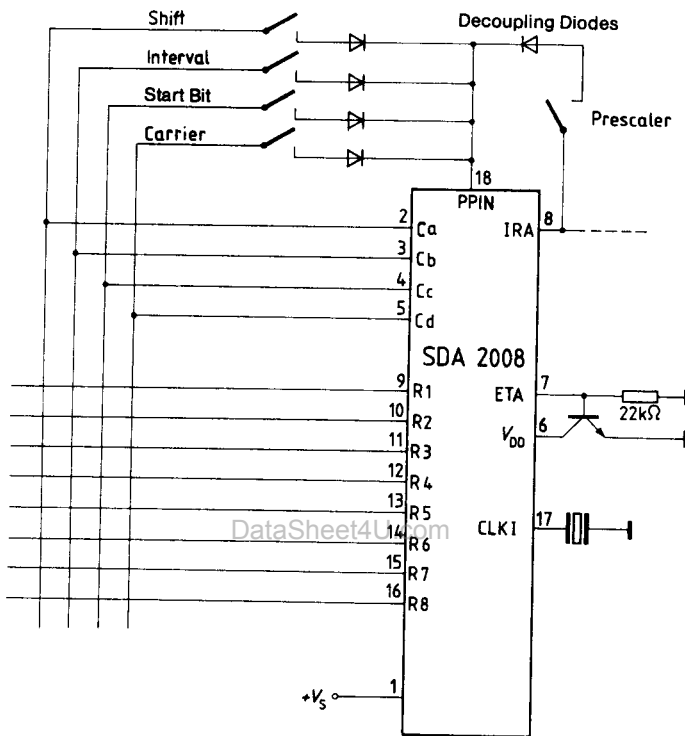
SB: = Instruction No. 62

PPIN connection

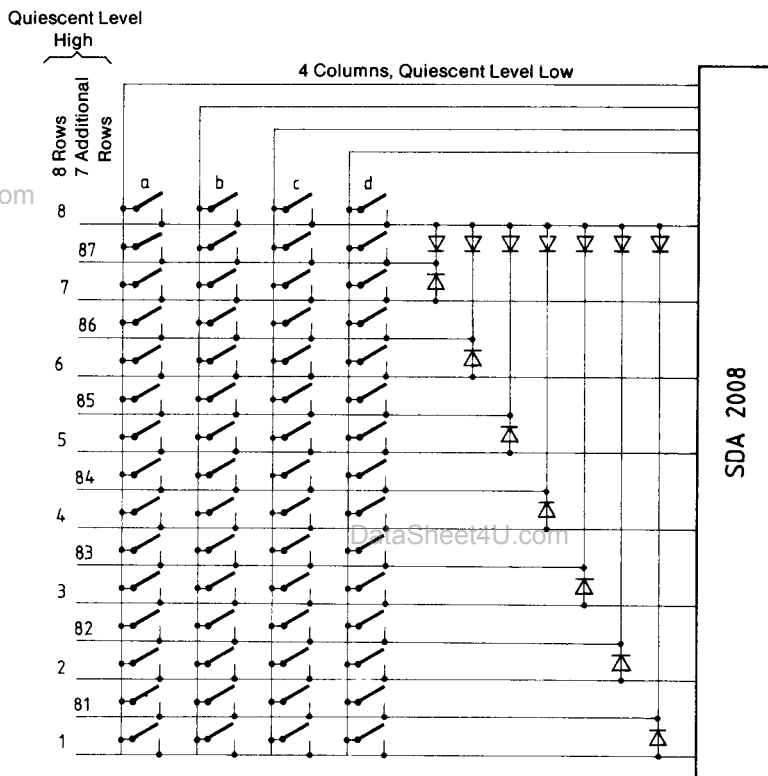

Extension for 60 instructions with additional diodes



$-V_S$ as fifth matrix column

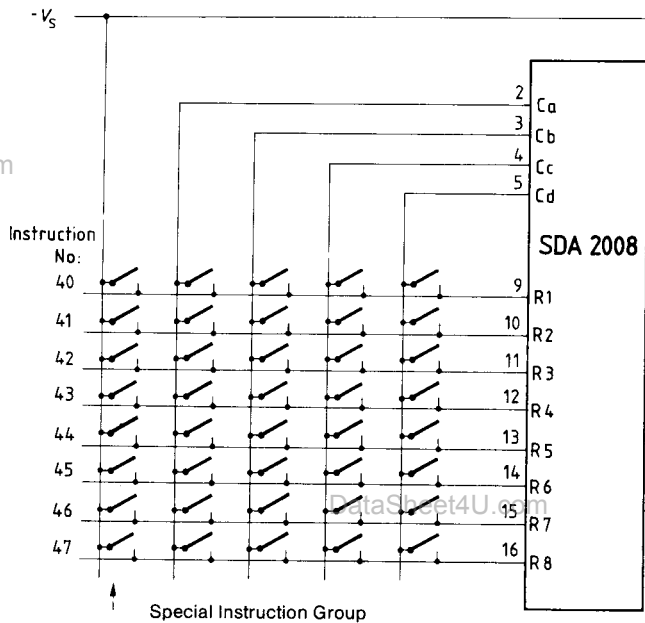

et4U.com

DataShee

DataSheet4U.com

Application circuit

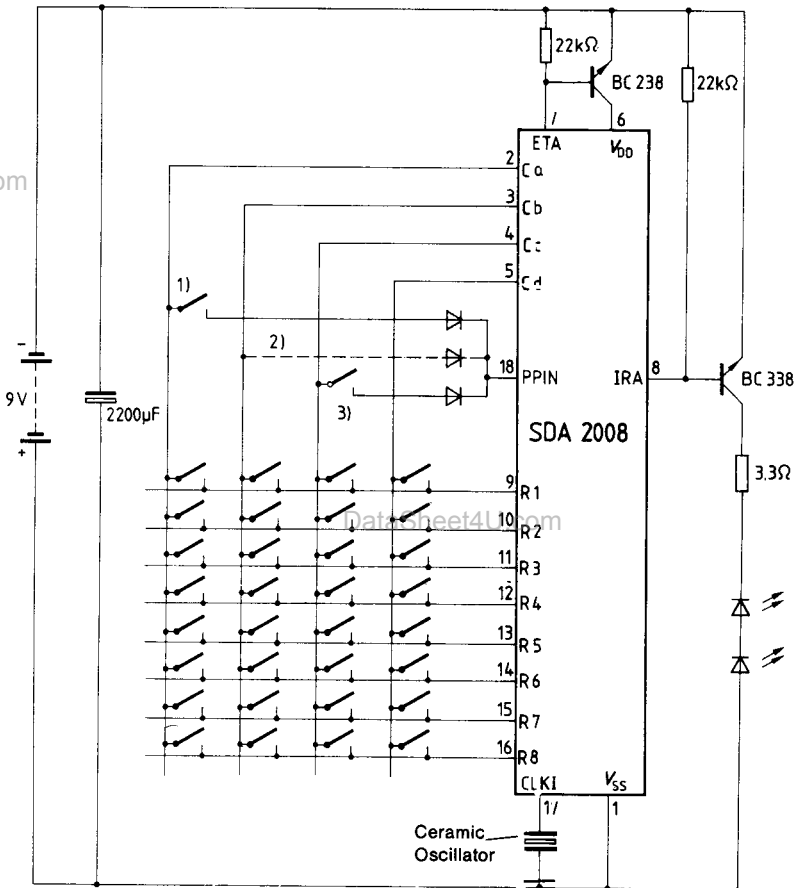

- 1) Shift key
- 2) Connection for shortened instruction interval
- 3) Start bit changeover

If only one of these three possibilities is used, no diode is required.