

Silicon Carbide Schottky Diode

- Revolutionary semiconductor material - Silicon Carbide
- Switching behavior benchmark
- No reverse recovery
- No temperature influence on the switching behavior
- No forward recovery

Product Summary

| | | |
|-----------|-----|----|
| V_{RRM} | 300 | V |
| Q_C | 23 | nC |
| I_F | 10 | A |

P-TO220-2-2.

P-TO220-3.SMD

P-TO220-3-1.

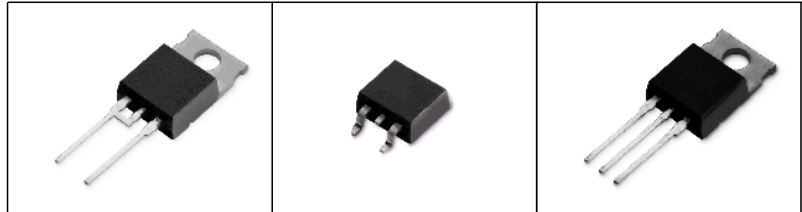

| Type | Package | Ordering Code | Marking | Pin 1 | PIN 2 | PIN 3 |
|----------|---------------|---------------|---------|-------|-------|-------|
| SDP10S30 | P-TO220-3-1. | Q67040-S4372 | D10S30 | n.c. | C | A |
| SDB10S30 | P-TO220-3.SMD | Q67040-S4373 | D10S30 | n.c. | C | A |
| SDT10S30 | P-TO220-2-2. | Q67040-S4447 | D10S30 | C | A | |

Maximum Ratings, at $T_j = 25^\circ\text{C}$, unless otherwise specified

| Parameter | Symbol | Value | Unit |
|---|----------------|-------------|----------------------|
| Continuous forward current, $T_C=100^\circ\text{C}$ | I_F | 10 | A |
| RMS forward current, $f=50\text{Hz}$ | I_{FRMS} | 14 | |
| Surge non repetitive forward current, sine halfwave $T_C=25^\circ\text{C}$, $t_p=10\text{ms}$ | I_{FSM} | 36 | |
| Repetitive peak forward current $T_j=150^\circ\text{C}$, $T_C=100^\circ\text{C}$, $D=0.1$ | I_{FRM} | 45 | |
| Non repetitive peak forward current $t_p=10\mu\text{s}$, $T_C=25^\circ\text{C}$ | I_{FMAX} | 100 | |
| i^2t value, $T_C=25^\circ\text{C}$, $t_p=10\text{ms}$ | $\int I^2 dt$ | 6.5 | A^2s |
| Repetitive peak reverse voltage | V_{RRM} | 300 | V |
| Surge peak reverse voltage | V_{RSM} | 300 | |
| Power dissipation, $T_C=25^\circ\text{C}$ | P_{tot} | 65 | W |
| Operating and storage temperature | T_j, T_{stg} | -55... +175 | $^\circ\text{C}$ |

Thermal Characteristics

| Parameter | Symbol | Values | | | Unit |
|---|------------|--------|------|------|------|
| | | min. | typ. | max. | |
| Characteristics | | | | | |
| Thermal resistance, junction - case | R_{thJC} | - | - | 2.3 | K/W |
| SMD version, device on PCB: | R_{thJA} | | | | |
| P-TO263-3-2: @ min. footprint | | - | - | 62 | |
| P-TO263-3-2: @ 6 cm ² cooling area ¹⁾ | | - | 35 | - | |

Electrical Characteristics, at $T_j = 25\text{ }^\circ\text{C}$, unless otherwise specified

| Parameter | Symbol | Values | | | Unit |
|--|--------|--------|------|------|---------------|
| | | min. | typ. | max. | |
| Static Characteristics | | | | | |
| Diode forward voltage | V_F | | | | V |
| $I_F=10\text{A}, T_j=25^\circ\text{C}$ | | - | 1.5 | 1.7 | |
| $I_F=10\text{A}, T_j=150^\circ\text{C}$ | | - | 1.5 | 1.9 | |
| Reverse current | I_R | | | | μA |
| $V_R=300\text{V}, T_j=25^\circ\text{C}$ | | - | 15 | 200 | |
| $V_R=300\text{V}, T_j=150^\circ\text{C}$ | | - | 20 | 1000 | |

¹Device on 40mm*40mm*1.5mm epoxy PCB FR4 with 6cm² (one layer, 70 μm thick) copper area for drain connection. PCB is vertical without blown air.

Electrical Characteristics, at $T_j = 25\text{ }^\circ\text{C}$, unless otherwise specified

| Parameter | Symbol | Values | | | Unit |
|---|----------|--------|-----------------|------|------|
| | | min. | typ. | max. | |
| AC Characteristics | | | | | |
| Total capacitive charge ¹⁾ $V_R=200\text{V}, I_F=10\text{A}, di_F/dt=-200\text{A}/\mu\text{s}, T_j=150^\circ\text{C}$ | Q_C | - | 23 | - | nC |
| Switching time ²⁾ $V_R=200\text{V}, I_F=10\text{A}, di_F/dt=-200\text{A}/\mu\text{s}, T_j=150^\circ\text{C}$ | t_{rr} | - | n.a. | - | ns |
| Total capacitance $V_R=0\text{V}, T_C=25^\circ\text{C}, f=1\text{MHz}$ $V_R=150\text{V}, T_C=25^\circ\text{C}, f=1\text{MHz}$ $V_R=300\text{V}, T_C=25^\circ\text{C}, f=1\text{MHz}$ | C | - | 600 55 40 | - | pF |

1 Power dissipation

$P_{tot} = f(T_C)$

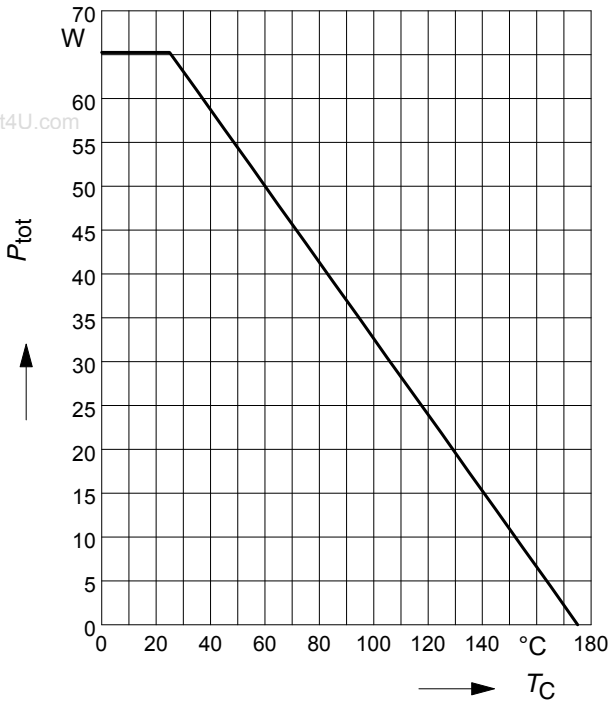

2 Diode forward current

$I_F = f(T_C)$

parameter: $T_j \leq 175^\circ\text{C}$

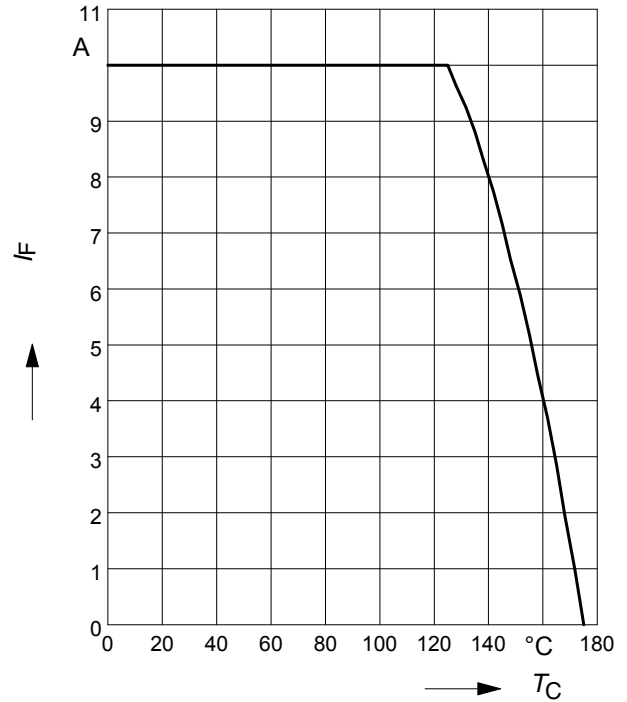

3 Typ. forward characteristic

$I_F = f(V_F)$

parameter: T_j , $t_p = 350 \mu\text{s}$

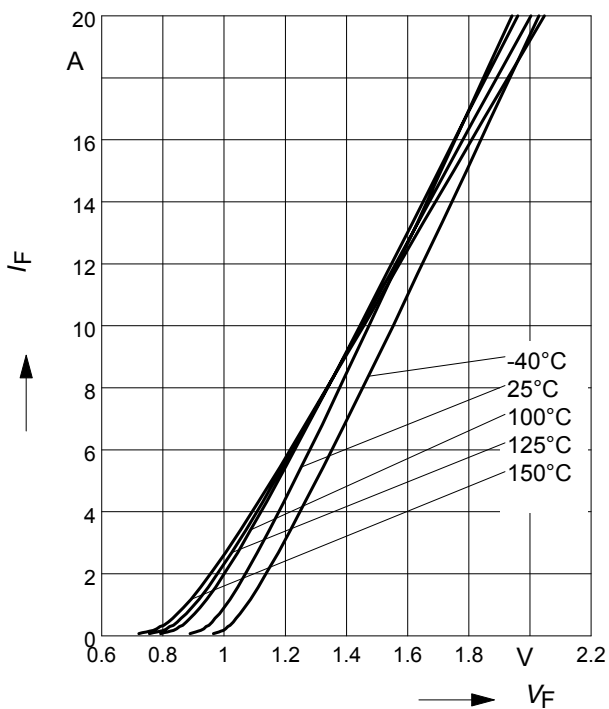

4 Typ. forward power dissipation vs. average forward current

$P_{F(AV)} = f(I_F)$ $T_C = 100^\circ\text{C}$, $d = t_p/T$

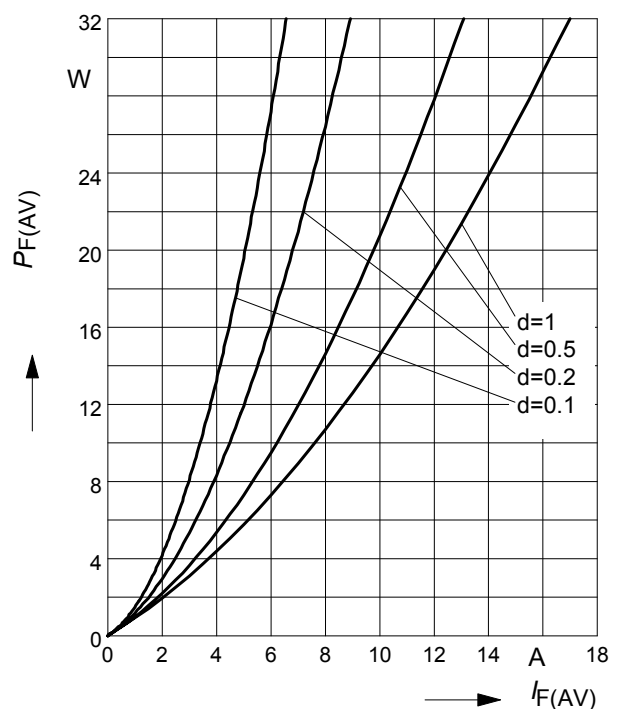

5 Typ. reverse current vs. reverse voltage

$$I_R = f(V_R)$$

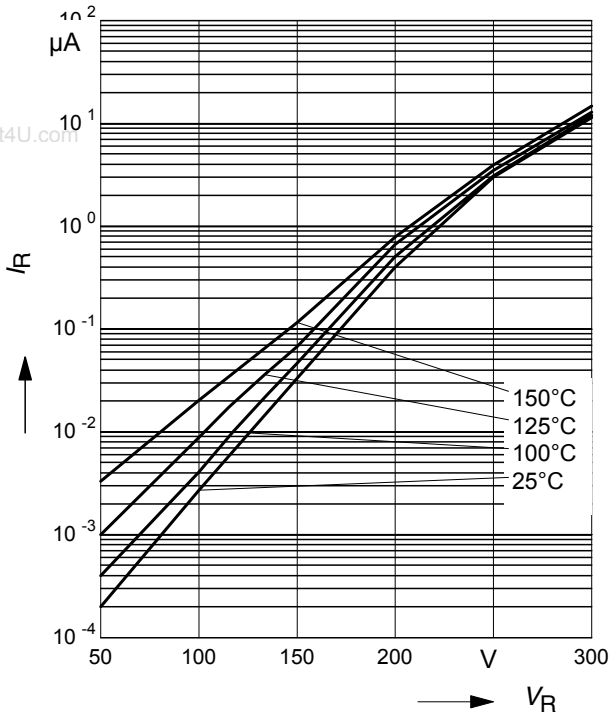

6 Transient thermal impedance

$$Z_{thJC} = f(t_p)$$

parameter : $D = t_p/T$

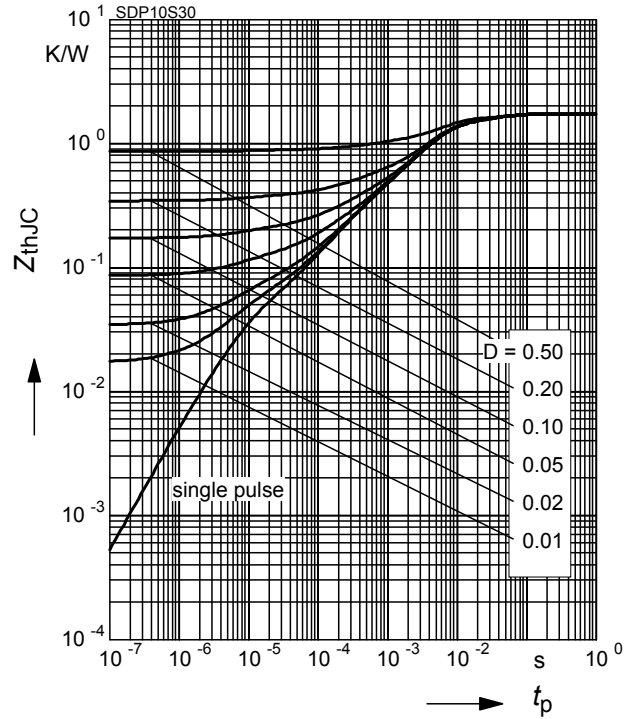

7 Typ. capacitance vs. reverse voltage

$$C = f(V_R)$$

parameter: $T_C = 25^\circ C$, $f = 1$ MHz

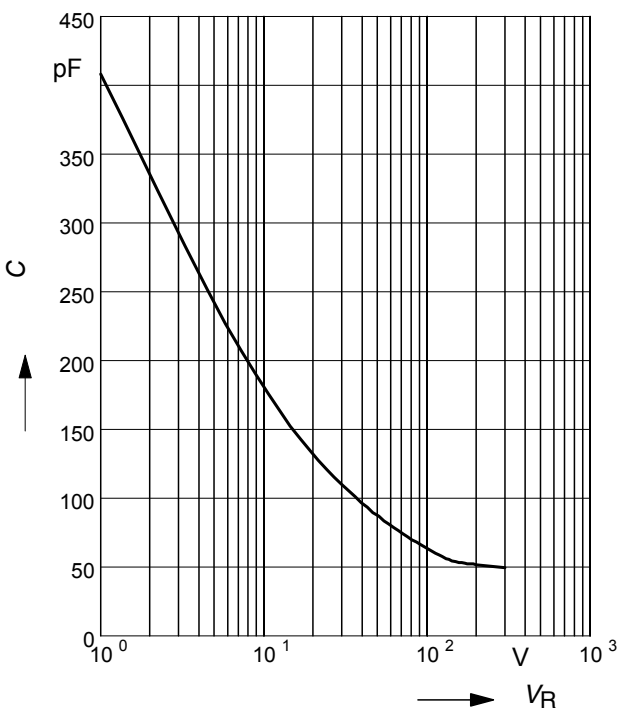

8 Typ. C stored energy

$$E_C = f(V_R)$$

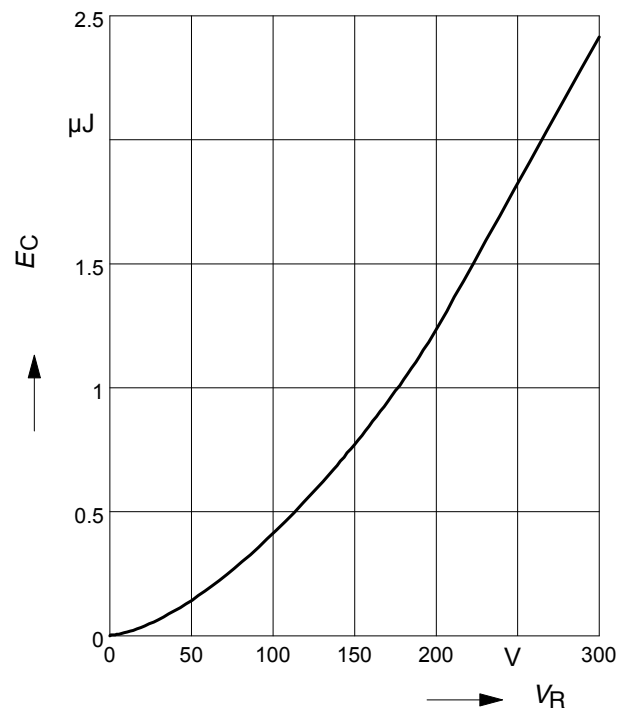

9 Typ. capacitive charge vs. current slope

$$Q_c = f(di_F/dt)$$

parameter: $T_j = 150\text{ }^\circ\text{C}$

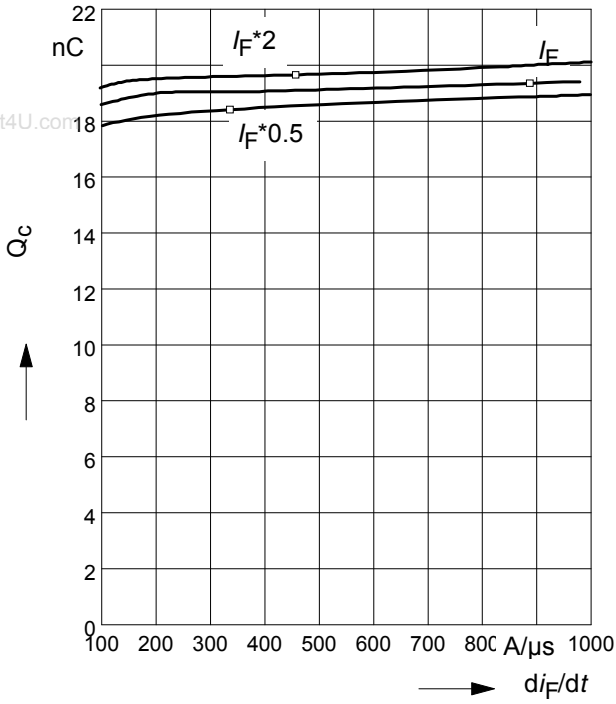

P-TO220-3-1

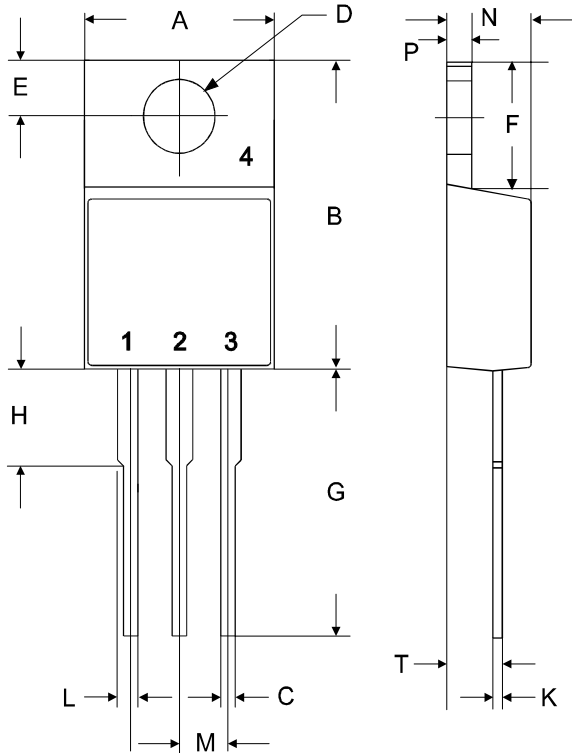

| symbol | dimensions | | | |
|--------|------------|-------|----------|--------|
| | [mm] | | [inch] | |
| | min | max | min | max |
| A | 9.70 | 10.30 | 0.3819 | 0.4055 |
| B | 14.88 | 15.95 | 0.5858 | 0.6280 |
| C | 0.65 | 0.86 | 0.0256 | 0.0339 |
| D | 3.55 | 3.89 | 0.1398 | 0.1531 |
| E | 2.60 | 3.00 | 0.1024 | 0.1181 |
| F | 6.00 | 6.80 | 0.2362 | 0.2677 |
| G | 13.00 | 14.00 | 0.5118 | 0.5512 |
| H | 4.35 | 4.75 | 0.1713 | 0.1870 |
| K | 0.38 | 0.65 | 0.0150 | 0.0256 |
| L | 0.95 | 1.32 | 0.0374 | 0.0520 |
| M | 2.54 typ. | | 0.1 typ. | |
| N | 4.30 | 4.50 | 0.1693 | 0.1772 |
| P | 1.17 | 1.40 | 0.0461 | 0.0551 |
| T | 2.30 | 2.72 | 0.0906 | 0.1071 |

TO-220-3-45 (P-TO220SMD)

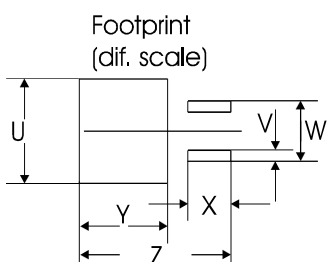
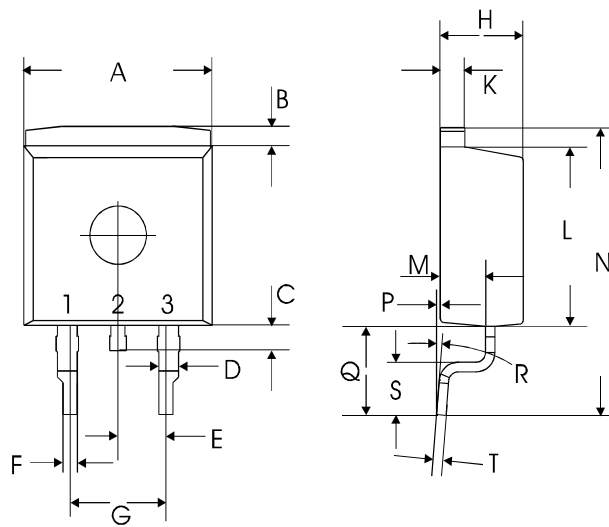

| symbol | dimensions | | | |
|--------|------------|-------|-------------|--------|
| | [mm] | | [inch] | |
| | min | max | min | max |
| A | 9.80 | 10.00 | 0.3858 | 0.3937 |
| B | 1.3 typ. | | 0.0512 typ. | |
| C | 1.25 | 1.75 | 0.0492 | 0.0689 |
| D | 0.95 | 1.15 | 0.0374 | 0.0453 |
| E | 2.54 typ. | | 0.1 typ. | |
| F | 0.72 | 0.85 | 0.0283 | 0.0335 |
| G | 5.08 typ. | | 0.2 typ. | |
| H | 4.30 | 4.50 | 0.1693 | 0.1772 |
| K | 1.28 | 1.40 | 0.0504 | 0.0551 |
| L | 9.00 | 9.40 | 0.3543 | 0.3701 |
| M | 2.30 | 2.50 | 0.0906 | 0.0984 |
| N | 14.1 typ. | | 0.5551 typ. | |
| P | 0.00 | 0.20 | 0.0000 | 0.0079 |
| Q | 3.30 | 3.90 | 0.1299 | 0.1535 |
| R | 8° max | | 8° max | |
| S | 1.70 | 2.50 | 0.0669 | 0.0984 |
| T | 0.50 | 0.65 | 0.0197 | 0.0256 |
| U | 10.8 typ. | | 0.4252 typ. | |
| V | 1.35 typ. | | 0.0532 typ. | |
| W | 6.43 typ. | | 0.2532 typ. | |
| X | 4.60 typ. | | 0.1811 typ. | |
| Y | 9.40 typ. | | 0.3701 typ. | |
| Z | 16.15 typ. | | 0.6358 typ. | |

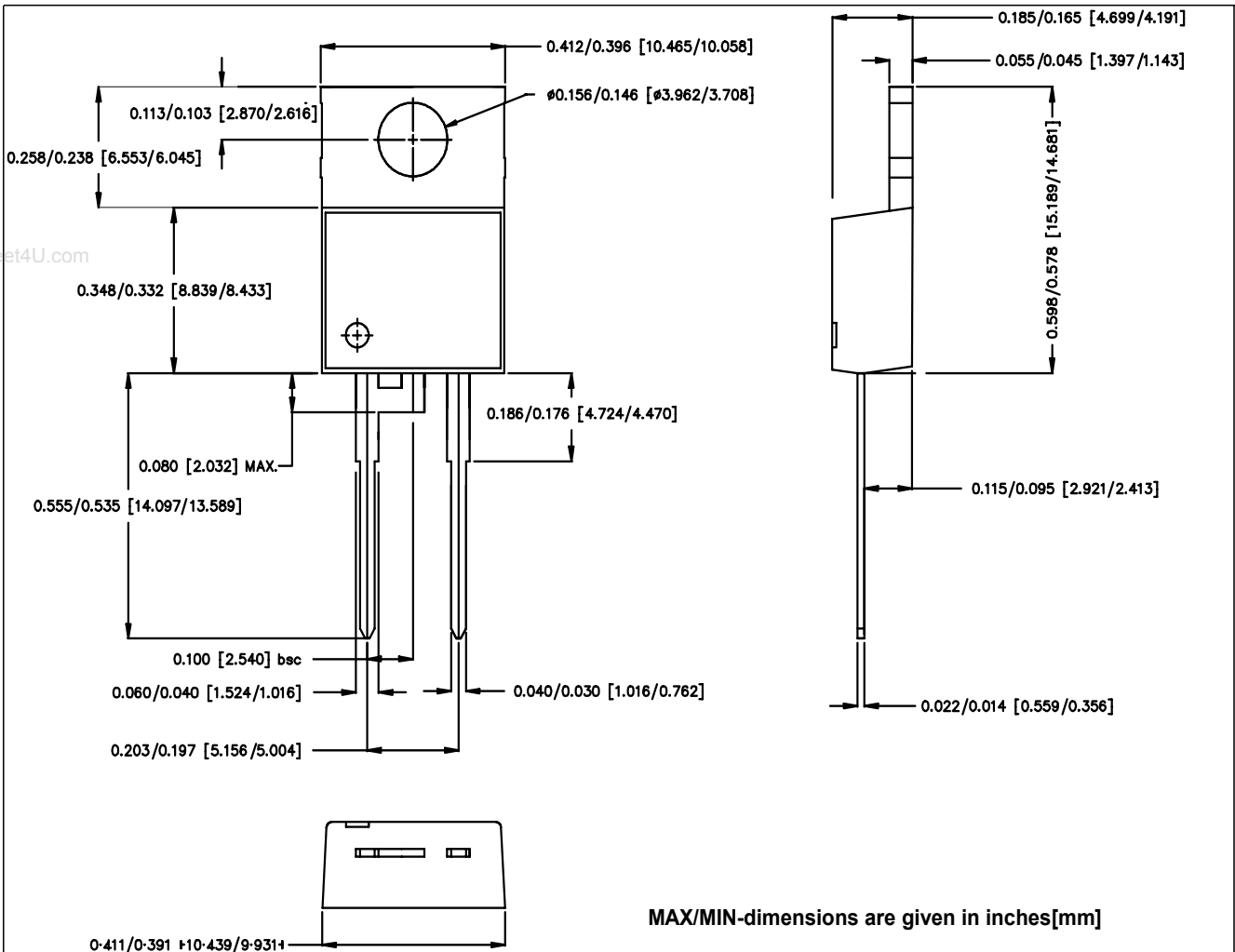

Published by
Infineon Technologies AG,
Bereichs Kommunikation
St.-Martin-Strasse 53,
D-81541 München
© Infineon Technologies AG 1999
All Rights Reserved.

Attention please!

The information herein is given to describe certain components and shall not be considered as warranted characteristics.

Terms of delivery and rights to technical change reserved.

We hereby disclaim any and all warranties, including but not limited to warranties of non-infringement, regarding circuits, descriptions and charts stated herein.

Infineon Technologies is an approved CECC manufacturer.

Information

For further information on technology, delivery terms and conditions and prices please contact your nearest Infineon Technologies Office in Germany or our Infineon Technologies Representatives worldwide (see address list).

Warnings

Due to technical requirements components may contain dangerous substances.

For information on the types in question please contact your nearest Infineon Technologies Office.

Infineon Technologies Components may only be used in life-support devices or systems with the express written approval of Infineon Technologies, if a failure of such components can reasonably be expected to cause the failure of that life-support device or system, or to affect the safety or effectiveness of that device or system. Life support devices or systems are intended to be implanted in the human body, or to support and/or maintain and sustain and/or protect human life. If they fail, it is reasonable to assume that the health of the user or other persons may be endangered.