

HIGH VOLTAGE SCHOTTKY RECTIFIER

Features

- Low forward voltage drop
- Low power loss and High efficiency
- Low leakage current
- Dual common cathode rectifier
- Halogen free and RoHS compliant device

Applications

- High efficiency SMPS
- Output rectification
- High frequency switching
- Freewheeling
- DC-DC converter systems

Description

The SDB20200DI has two schottky barriers arranged in a common cathode configuration and is ideally suited for a full wave output rectifier in low switching power supplies and DC to DC converters where small size and high reliability are required.

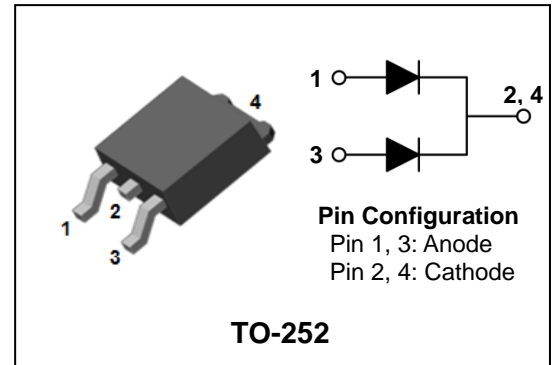

Product Characteristics

$I_{F(AV)}$	2 x 10A
V_{RRM}	200V
V_{FM} at 125°C	0.88V (Max.)
I_{FSM}	120A

Ordering Information

Device	Marking Code	Package	Packaging
SDB20200DI	SDB20200DI	TO-252	Tape & Reel

Marking Information

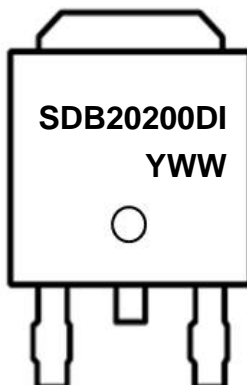

SDB20200DI = Specific Device Code

YWW = Year & Week Code Marking

-. Y = Year Code

-. WW = Week Code

Absolute Maximum Ratings (Limiting Values)

Characteristic		Symbol	Value	Unit
Maximum repetitive reverse voltage Maximum working peak reverse voltage Maximum DC blocking voltage		V_{RRM} V_{RWM} V_R	200	V
Maximum average forward rectified current	per diode	$I_{F(AV)}$	10	A
	total device		20	
Peak forward surge current 8.3ms single half sine-wave superimposed on rated load per diode		I_{FSM}	120	A
Storage temperature range		T_{stg}	-55 to +150	°C
Maximum operating junction temperature		T_j	150	

Thermal Characteristics

Characteristic		Symbol	Value	Unit
Maximum thermal resistance junction to case	per diode	$R_{th(j-c)}$	6.0	°C/W
	total device		5.6	

Electrical Characteristics (Per Diode)

Characteristic	Symbol	Test Condition	Min.	Typ.	Max.	Unit	
Peak forward voltage drop	$V_{FM}^{(1)}$	$I_{FM} = 10A$	$T_j=25^\circ C$	-	-	0.95	V
			$T_j=125^\circ C$	-	-	0.88	V
Reverse leakage current	$I_{RM}^{(1)}$	$V_R = V_{RRM}$	$T_j=25^\circ C$	-	-	20	uA
			$T_j=125^\circ C$	-	-	10	mA
Junction capacitance	C_j	$V_R = 10V_{DC}, f=1MHz$	-	100	-	pF	

Note : (1) Pulse test : $t_p \leq 380\mu s$, Duty cycle $\leq 2\%$

Rating and Characteristic Curves

Fig. 1) Typical Forward Characteristics (Per diode)

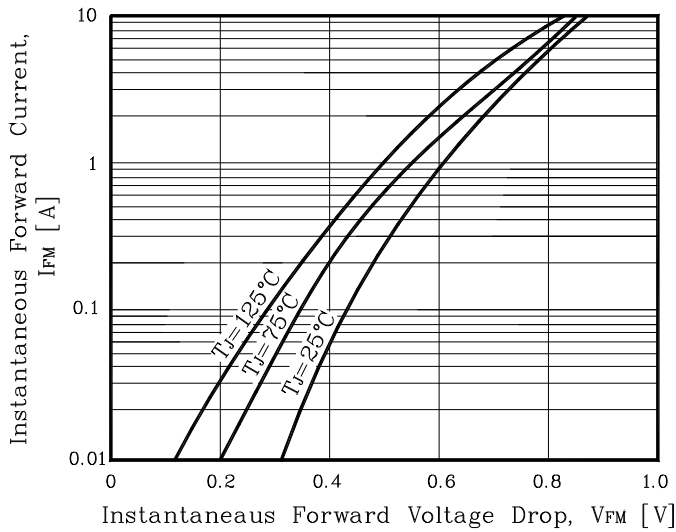

Fig. 2) Typical Reverse Characteristics (Per diode)

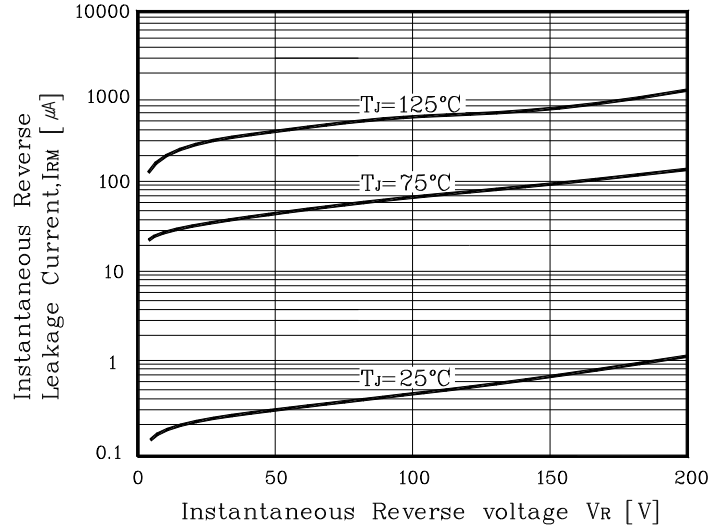

Fig. 3) Maximum Forward Derivative Curve

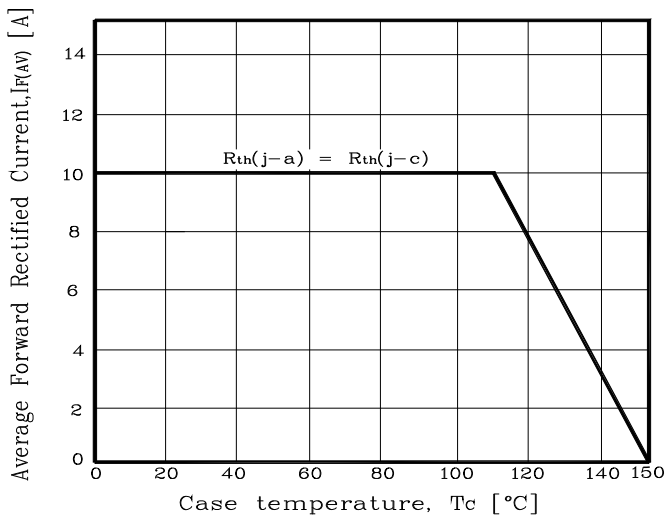

Fig. 4) Forward Power Dissipation (Per diode)

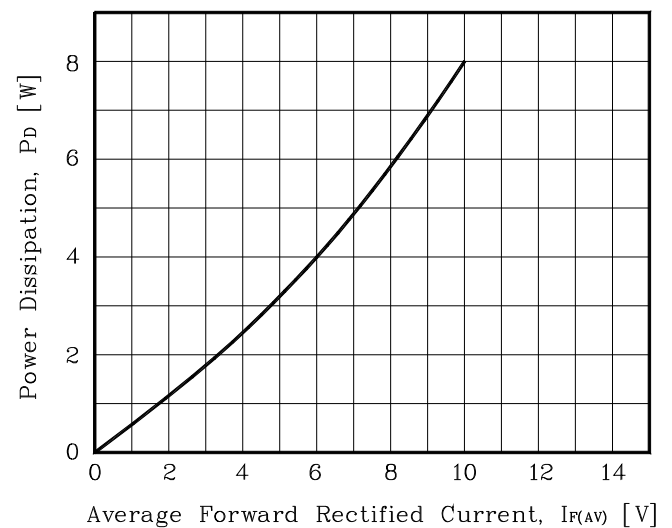

Fig. 5) Maximum Non-Repetitive Peak Forward Surge Current (Per diode)

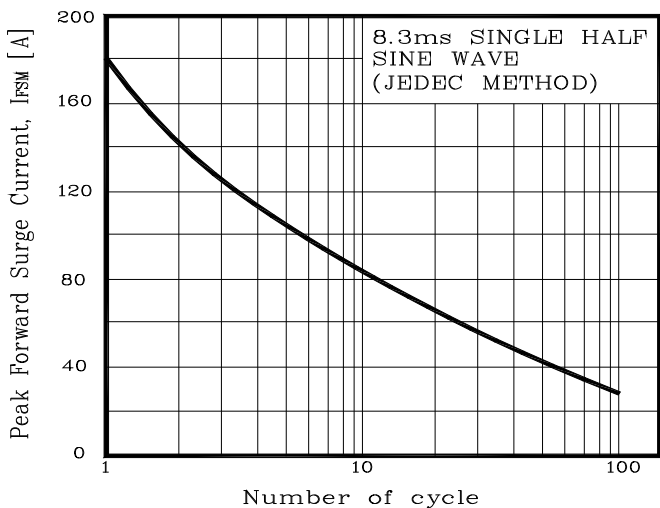
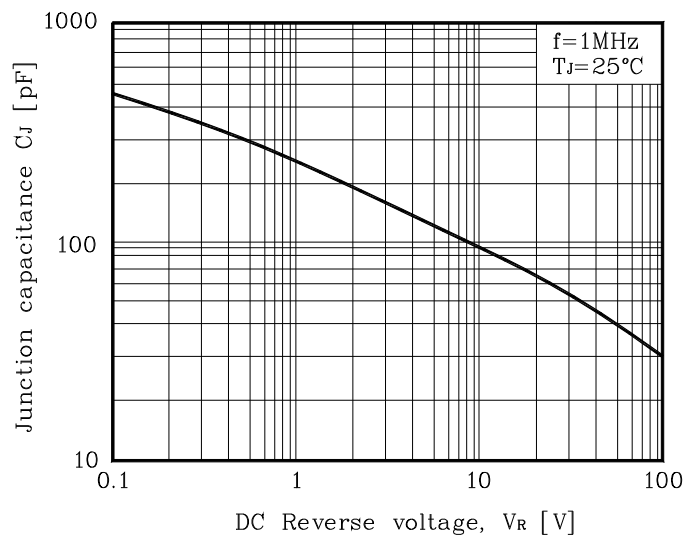
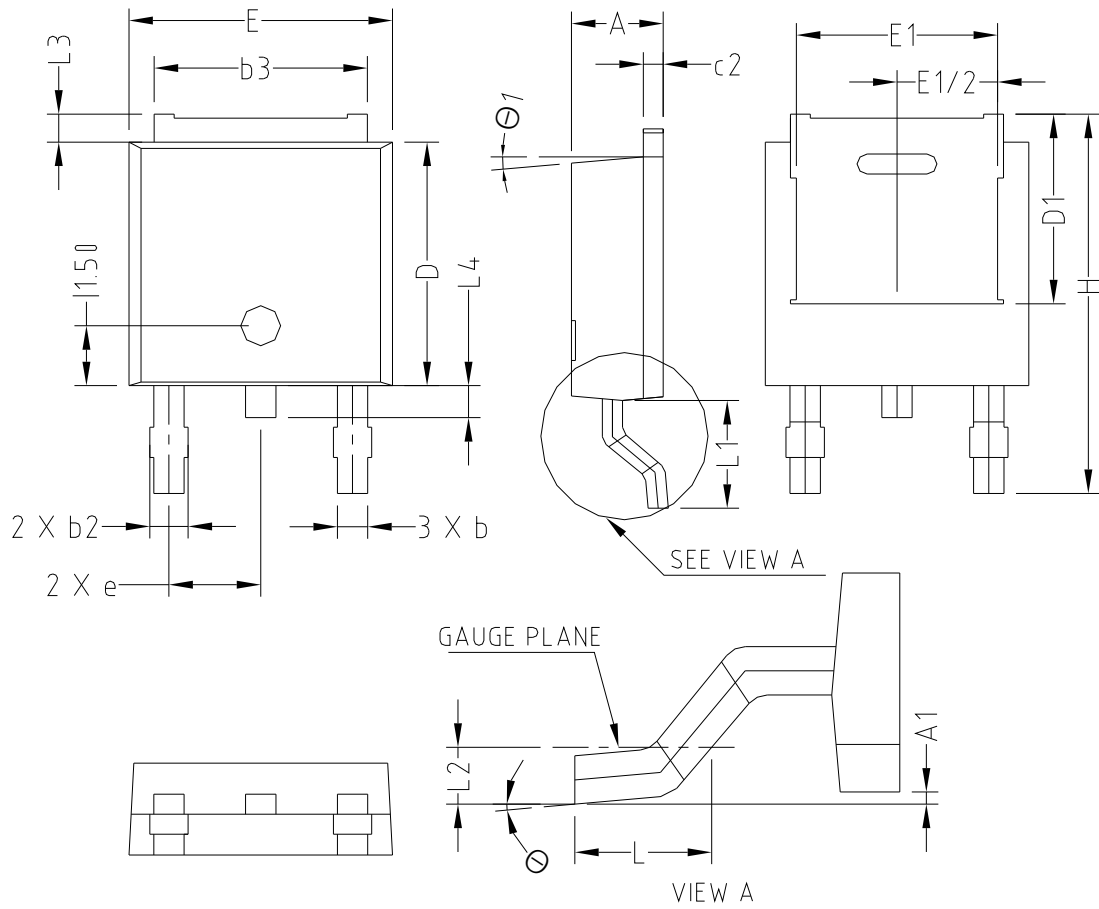

Fig. 6) Typical Junction Capacitance (Per diode)



Package Outline Dimension



SYMBOL	MILLIMETERS			NOTE
	MINIMUM	NOMINAL	MAXIMUM	
A	2.20	2.30	2.40	
A1	0.00		0.127	
b	0.66	0.76	0.86	
b2	-	-	0.96	
b3	5.04	5.34	5.64	
c2	0.40	0.50	0.60	
D	5.90	6.10	6.30	
D1	4.75			
E	6.40	6.60	6.80	
E1	5.04			
e	2.30 BSC			
H	9.20	9.50	9.80	
L	1.27	1.47	1.67	
L1	2.50	2.70	2.90	
L2	0.508 BSC			
L3	0.50	0.70	0.90	
L4	0.60	0.80	1.00	
Θ	0°	-	10°	
$\Theta 1$	5°			

The AUK Corp. products are intended for the use as components in general electronic equipment (Office and communication equipment, measuring equipment, home appliance, etc.).

Please make sure that you consult with us before you use these AUK Corp. products in equipments which require high quality and / or reliability, and in equipments which could have major impact to the welfare of human life(atomic energy control, airplane, spaceship, transportation, combustion control, all types of safety device, etc.). AUK Corp. cannot accept liability to any damage which may occur in case these AUK Corp. products were used in the mentioned equipments without prior consultation with AUK Corp..

Specifications mentioned in this publication are subject to change without notice.