

## HIGH VOLTAGE SCHOTTKY RECTIFIER

### Features

- Low forward voltage drop and leakage current
- Low power loss and High efficiency
- Guard-ring for overvoltage protection
- Dual common cathode rectifier
- Full lead (Pb)-free and RoHS compliant device

### Applications

- Power supply - Output rectification
- High efficiency SMPS
- Free-wheeling diode
- Reverse battery protection
- DC to DC systems

### Description

Schottky barrier rectifier designed for high frequency miniature Switched Mode Power Supplies such as adaptors and on board DC to DC converters.

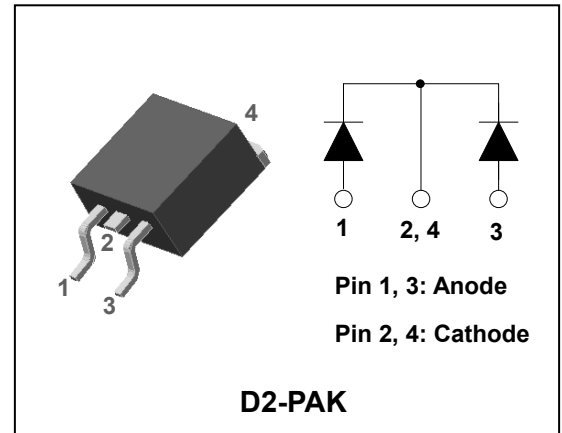

### Product Characteristics

$I_{F(AV)}$	2 X 15A
$V_{RRM}$	100V
$V_{FM}$ at 125°C	0.72V
$I_{FSM}$	210A

### Ordering Information

Device	Marking Code	Package	Packaging
SDB30D100D2	SDB30D100D2	D2-PAK	Tape & Reel

### Marking Information

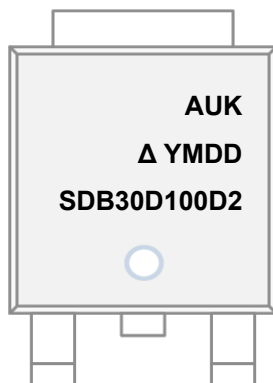

AUK = Manufacture Logo

Δ = Control Code of Manufacture

YMDD = Date Code Marking

- . Y = Year Code

- . M = Monthly Code

- . DD = Daily Code

SDB30D100D2 = Specific Device Code

## Absolute Maximum Ratings (Limiting Values)

Characteristic		Symbol	Value	Unit
Maximum repetitive reverse voltage Maximum working peak reverse voltage Maximum DC blocking voltage		$V_{RRM}$ $V_{RWM}$ $V_R$	100	V
Maximum average forward rectified current	per diode	$I_{F(AV)}$	15	A
	total device		30	
Peak forward surge current 8.3ms single half sine-wave superimposed on rated load per diode		$I_{FSM}$	210	A
Storage temperature range		$T_{stg}$	-45 to +150	°C
Maximum operating junction temperature		$T_J$	150	

## Thermal Characteristics

Characteristic		Symbol	Value	Unit
Maximum thermal resistance junction to case	per diode	$R_{th(j-c)}$	3.5	°C/W
	total device		3.3	

## Electrical Characteristics (Per Diode)

Characteristic	Symbol	Test Condition	Min.	Typ.	Max.	Unit	
Peak forward voltage drop	$V_{FM}^{(1)}$	$I_{FM} = 15A$	$T_J = 25^\circ C$	-	-	0.85	V
			$T_J = 125^\circ C$	-	-	0.72	
Reverse leakage current	$I_{RM}^{(1)}$	$V_R = V_{RRM}$	$T_J = 25^\circ C$	-	-	0.2	mA
			$T_J = 125^\circ C$	-	-	30	
Junction capacitance	$C_j$	$V_R = 5V_{DC}, f = 1MHz$	-	280	-	pF	

**Note :** (1) Pulse test :  $t_p \leq 380\mu s$ , Duty cycle  $\leq 2\%$

## Rating and Characteristic Curves

**Fig. 1) Typical Forward Characteristics (Per diode)**

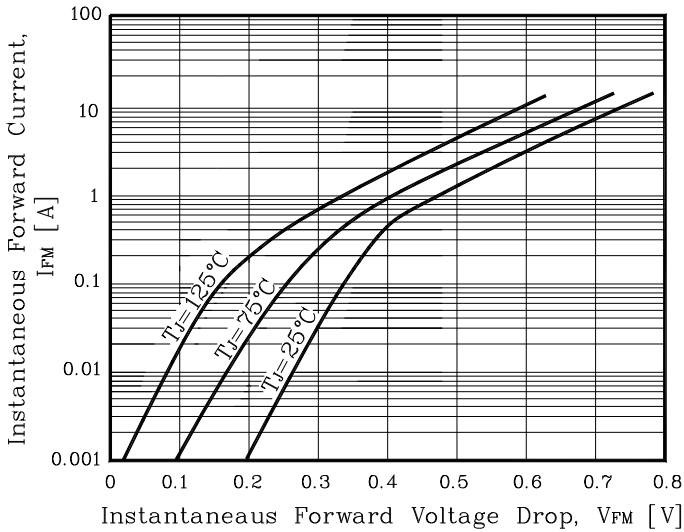

**Fig. 2) Typical Reverse Characteristics (Per diode)**

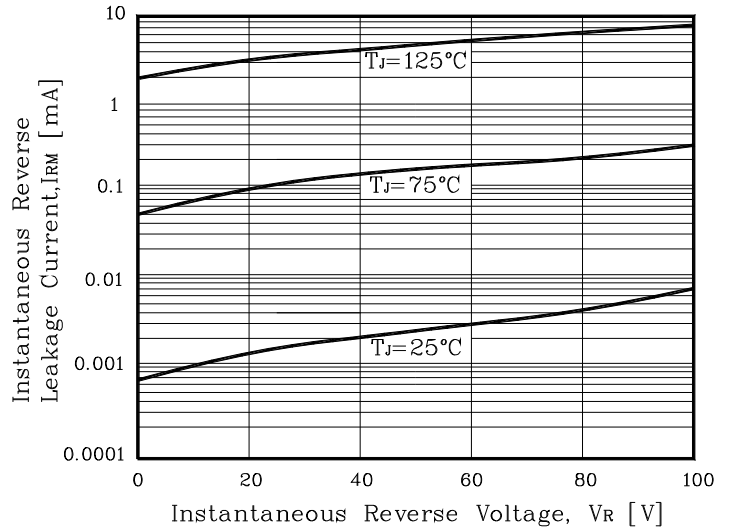

**Fig. 3) Maximum Forward Derivative Curve**

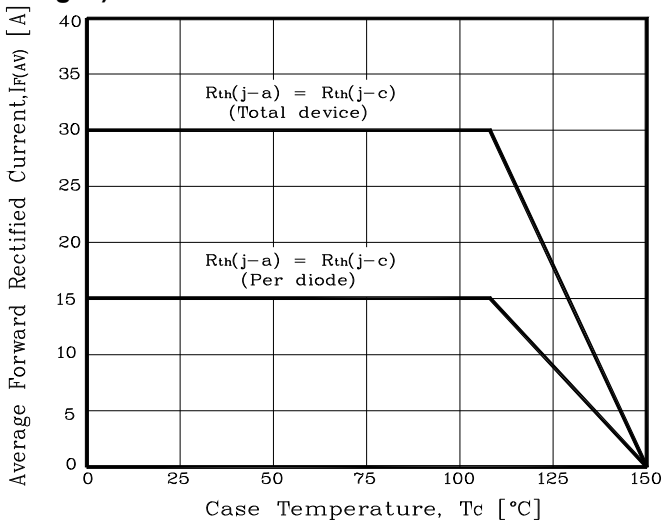

**Fig. 4) Forward Power Dissipation (Per diode)**

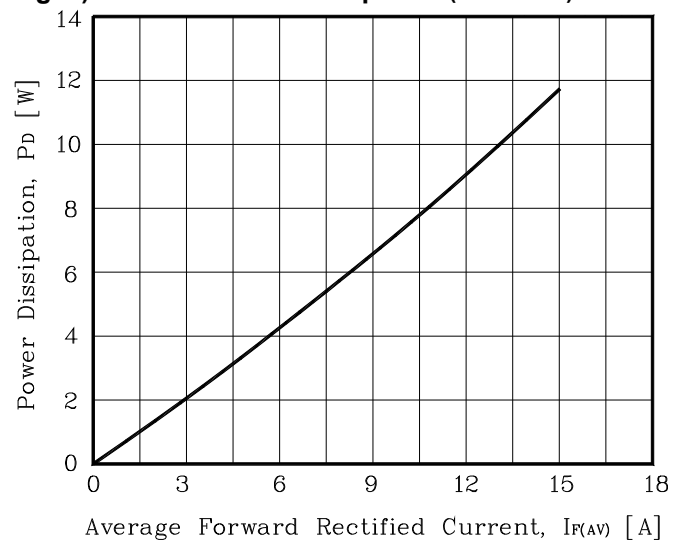

**Fig. 5) Maximum Non-Repetitive Peak Forward Surge Current (Per diode)**

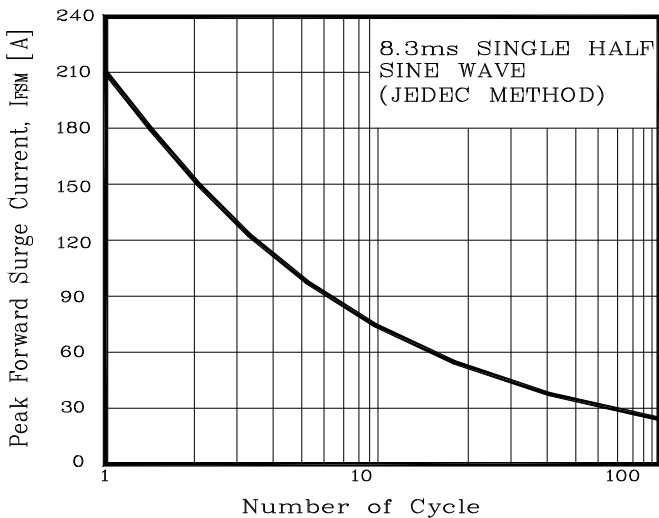

**Fig. 6) Typical Junction Capacitance (Per diode)**

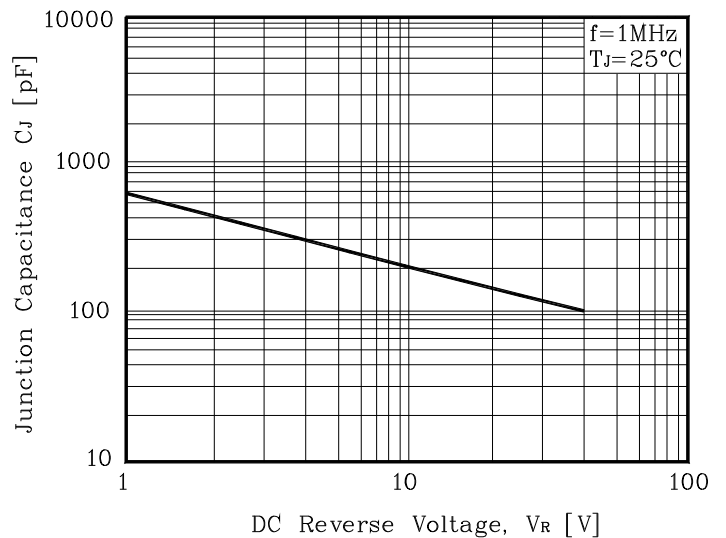

## Package Outline Dimension (Unit: mm)

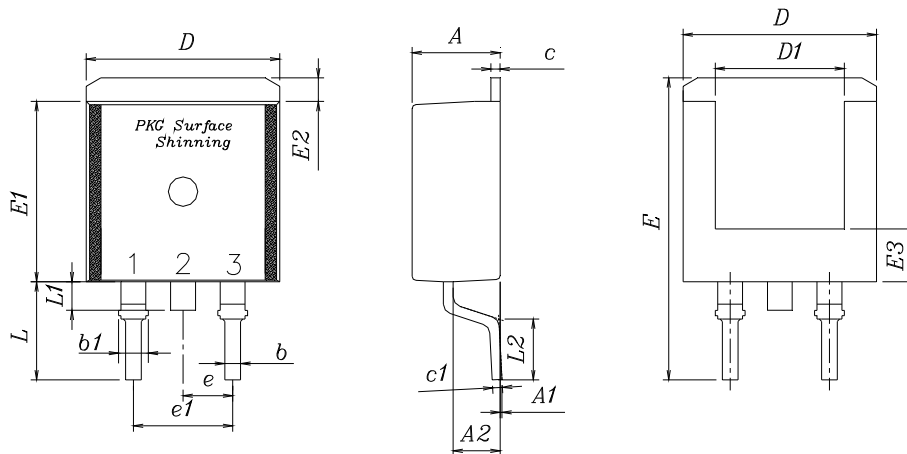

SYMBOL	MILLIMETERS			NOTE
	MINIMUM	NOMINAL	MAXIMUM	
A	4.35	4.50	4.65	
A1	—	—	0.15	
A2	2.20	2.40	2.60	
b	0.70	0.80	0.90	
b1	1.17	1.27	1.37	
c	0.40	0.50	0.60	
c1	0.40	0.50	0.60	
D	9.80	10.00	10.20	
D1	6.40	6.60	6.80	
E	15.00	15.40	15.80	
E1	9.05	9.20	9.35	
E2	1.00	1.20	1.40	
E3	2.50	2.70	2.90	
e	2.34	2.54	2.74	
e1	4.88	5.08	5.28	
L	4.60	5.00	5.40	
L1	1.40	1.45	1.50	
L2	2.50	—	—	

## ※ Recommend PCB solder land (Unit: mm)

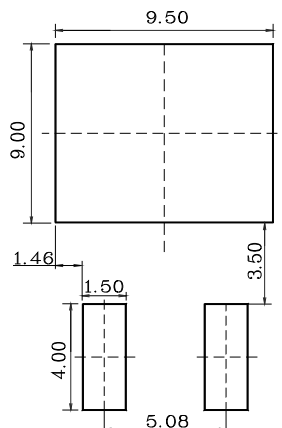

**The AUK Corp. products are intended for the use as components in general electronic equipment (Office and communication equipment, measuring equipment, home appliance, etc.).**

**Please make sure that you consult with us before you use these AUK Corp. products in equipments which require high quality and / or reliability, and in equipments which could have major impact to the welfare of human life(atomic energy control, airplane, spaceship, transportation, combustion control, all types of safety device, etc.). AUK Corp. cannot accept liability to any damage which may occur in case these AUK Corp. products were used in the mentioned equipments without prior consultation with AUK Corp..**

**Specifications mentioned in this publication are subject to change without notice.**