



SDP/B55N03L

N-Channel Logic Level Enhancement Mode Field Effect Transistor

PRODUCT SUMMARY		
V _{DS}	I _D	R _{DS(on)} (mΩ) TYP
30V	55A	12.5 @ V _{GS} = 10V
		20 @ V _{GS} = 4.5V

FEATURES

- Super high dense cell design for extremely low R_{DS(ON)}.
- High power and current handling capability.
- TO-220 & TO-263 package.

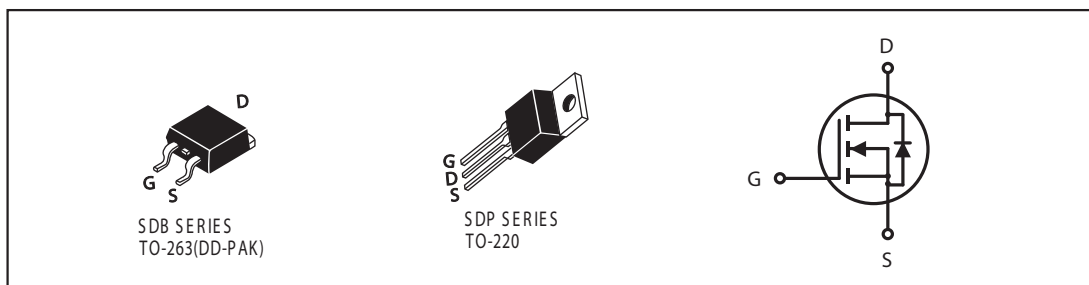

ABSOLUTE MAXIMUM RATINGS (T_C=25°C unless otherwise noted)

Parameter	Symbol	Limit	Unit
Drain-Source Voltage	V _{DS}	30	V
Gate-Source Voltage	V _{GS}	±20	V
Drain Current-Continuous @ T _J =125°C -Pulsed ^a	I _D	55	A
	I _{DM}	140	A
Drain-Source Diode Forward Current	I _S	55	A
Maximum Power Dissipation @ T _C =25°C Derate above 25°C	P _D	75	W
		0.5	W/°C
Operating and Storage Temperature Range	T _J , T _{STG}	-65 to 175	°C

THERMAL CHARACTERISTICS

Thermal Resistance, Junction-to-Case	R _{θJC}	2.5	°C/W
Thermal Resistance, Junction-to-Ambient	R _{θJA}	62.5	°C/W

SDP/B55N03L

ELECTRICAL CHARACTERISTICS ($T_c=25^{\circ}\text{C}$ unless otherwise noted)

Parameter	Symbol	Condition	Min	Typ	Max	Unit
OFF CHARACTERISTICS						
Drain-Source Breakdown Voltage	BV_{DSS}	$V_{GS}=0V, I_D=250\mu A$	30			V
Zero Gate Voltage Drain Current	I_{DSS}	$V_{DS}=24V, V_{GS}=0V$			10	μA
Gate-Body Leakage	I_{GSS}	$V_{GS}=\pm 16V, V_{DS}=0V$			± 100	nA
ON CHARACTERISTICS ^a						
Gate Threshold Voltage	$V_{GS(th)}$	$V_{DS}=V_{GS}, I_D=250\mu A$	1	1.5	3	V
Drain-Source On-State Resistance	$R_{DS(ON)}$	$V_{GS}=10V, I_D=27A$		12.5	14	m ohm
		$V_{GS}=4.5V, I_D=22A$		20	23	m ohm
On-State Drain Current	$I_{D(ON)}$	$V_{GS}=10V, V_{DS}=10V$	60			A
Forward Transconductance	g_{FS}	$V_{DS}=10V, I_D=27A$		32		S
DYNAMIC CHARACTERISTICS ^b						
Input Capacitance	C_{ISS}	$V_{DS}=15V, V_{GS}=0V$ $f=1.0\text{MHz}$		930		pF
Output Capacitance	C_{OSS}			340		pF
Reverse Transfer Capacitance	C_{RSS}			120		pF
SWITCHING CHARACTERISTICS ^b						
Turn-On Delay Time	$t_{D(ON)}$	$V_{DD}=15V,$ $I_D=1A,$ $V_{GS}=10V,$ $R_{GEN}=60\text{ ohm}$		17	16	ns
Rise Time	t_r			23	250	ns
Turn-Off Delay Time	$t_{D(OFF)}$			37	90	ns
Fall Time	t_f			20	200	ns
Total Gate Charge	Q_g	$V_{DS}=15V, I_D=27.5A, V_{GS}=10V$		26.1	35	nC
		$V_{DS}=15V, I_D=27.5A, V_{GS}=4.5V$		13.7	16.5	nC
Gate-Source Charge	Q_{gs}	$V_{DS}=15V, I_D=27.5A,$ $V_{GS}=10V$		5.4		nC
Gate-Drain Charge	Q_{gd}			4.6		nC

SDP/B55N03L

ELECTRICAL CHARACTERISTICS ($T_c=25^\circ\text{C}$ unless otherwise noted)

Parameter	Symbol	Condition	Min	Typ	Max	Unit
DRAIN-SOURCE DIODE CHARACTERISTICS ^a						
Diode Forward Voltage	V_{SD}	$V_{GS} = 0V, I_s = 26A$		0.9	1.3	V

Notes

a. Pulse Test: Pulse Width $\leq 300\mu\text{s}$, Duty Cycle $\leq 2\%$.

b. Guaranteed by design, not subject to production testing.

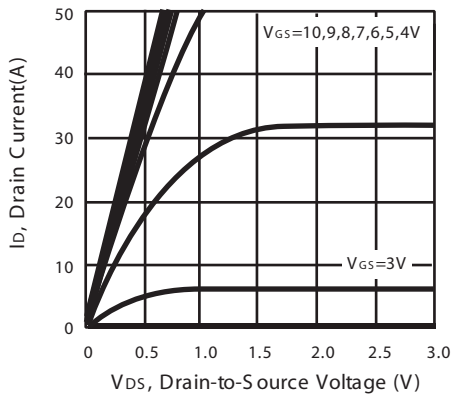

Figure 1. Output Characteristics

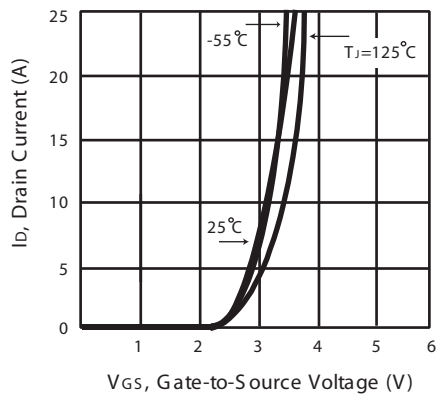

Figure 2. Transfer Characteristics

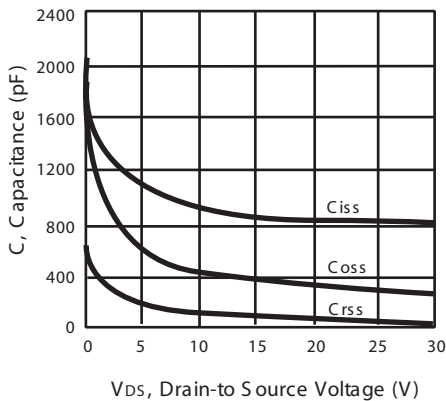

Figure 3. Capacitance

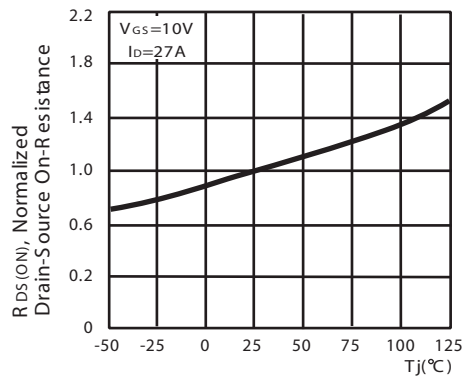

Figure 4. On-Resistance Variation with Temperature

SDP/B55N03L

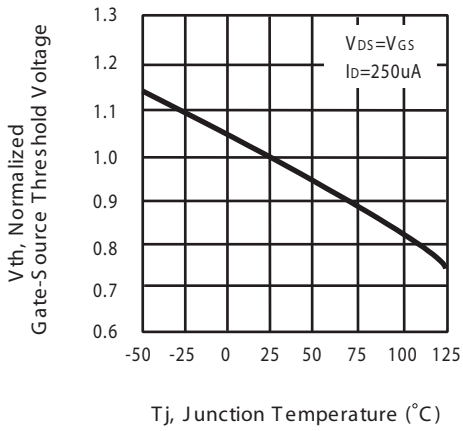

Figure 5. Gate Threshold Variation with Temperature

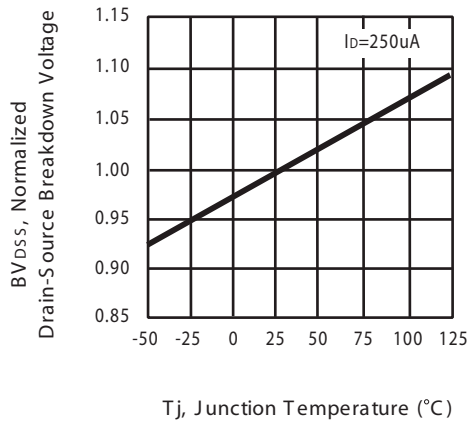

Figure 6. Breakdown Voltage Variation with Temperature

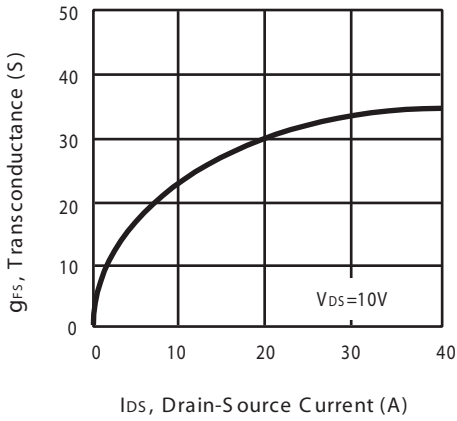

Figure 7. Transconductance Variation with Drain Current

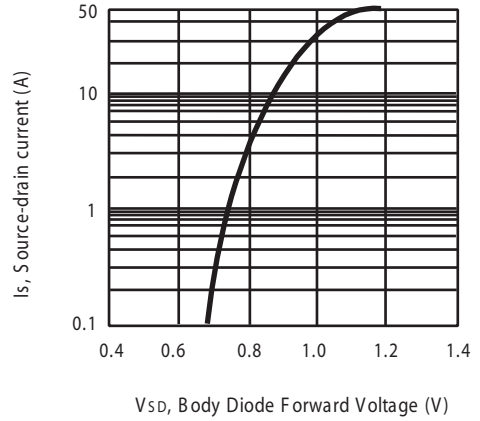

Figure 8. Body Diode Forward Voltage Variation with Source Current

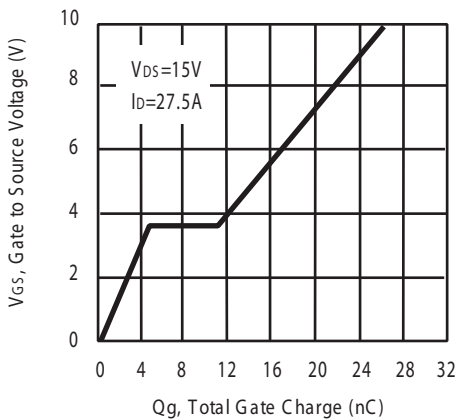

Figure 9. Gate Charge

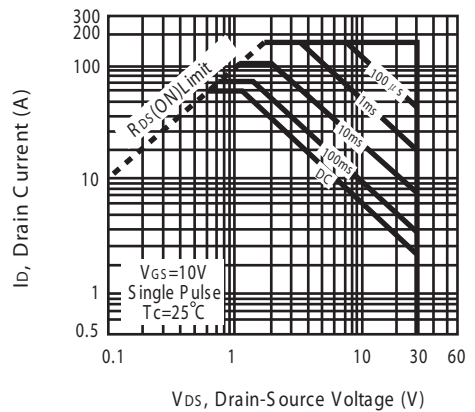

Figure 10. Maximum Safe Operating Area

SDP/B55N03L

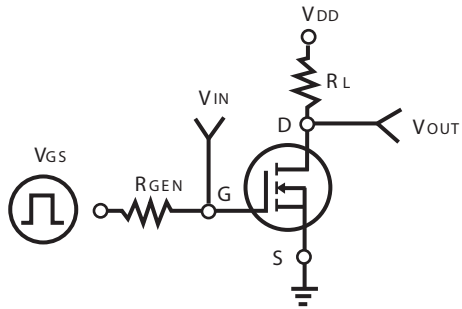

Figure 11. Switching Test Circuit

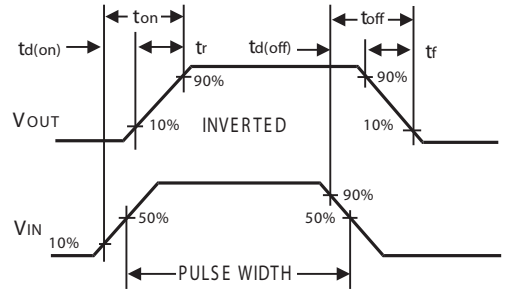

Figure 12. Switching Waveforms

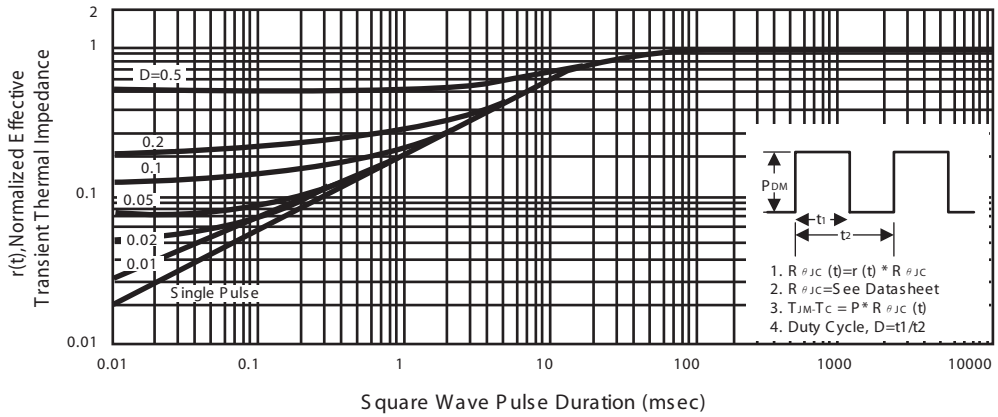

Figure 13. Normalized Thermal Transient Impedance Curve