

1. PART NO. EXPRESSION :

S D L 0 8 0 6 - R 5 6 M F

(a) (b) (c) (d)(e)

- (a) Series code
- (b) Dimension code
- (c) Inductance code : R56 = 0.56uH
- (d) Tolerance code : M = ±20%
- (e) F : Lead Free

2. CONFIGURATION & DIMENSIONS :

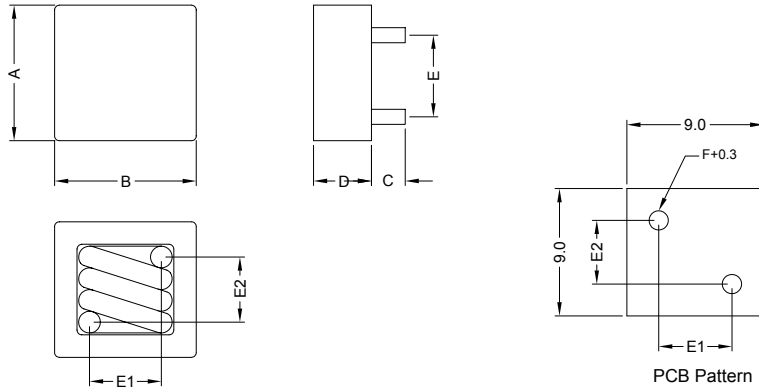

Part No.	A mm	B mm	C mm	D mm	E mm	E1 mm	E2 mm	F mm
SDL0806-R56MF	8.2 MAX.	8.2 MAX.	3.5±0.5	7.0 MAX.	6.3±0.5	4.5±0.5	4.4±0.5	0.9±0.1
SDL0806-R82MF	8.2 MAX.	8.2 MAX.	3.5±0.5	6.0 MAX.	6.2±0.5	4.5±0.5	4.3±0.5	0.8±0.1
SDL0806-1R2MF	8.2 MAX.	8.2 MAX.	3.5±0.5	6.0 MAX.	6.3±0.5	4.4±0.5	4.5±0.5	0.7±0.1

3. SCHEMATIC :

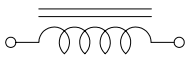

4. MATERIALS :

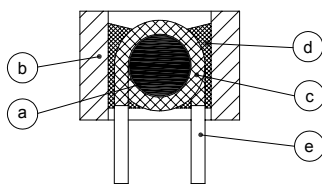

- (a) Core : Iron Powder R Core
- (b) Core : Iron Powder RI Core
- (c) Wire : Enamelled Copper Wire
- (d) Adhesive : Epoxy
- (e) Terminal : Tinned Copper Plate

5. GENERAL SPECIFICATION :

- a) Ambient temp. : 25°C
- b) Irms(A) : Will cause temperature rise approximately 40°C without core loss
- c) Isat(A) : Will cause Lo to drop approximately 20%



RoHS Compliant

NOTE : Specifications subject to change without notice. Please check our website for latest information.

05.05.2008



SUPERWORLD ELECTRONICS (S) PTE LTD

6. ELECTRICAL CHARACTERISTICS :

Part No.	Inductance L ₀ (μ H)	Test Frequency (Hz)	DCR (m Ω) $\pm 8\%$	I _{rms} (A) Max.	I _{sat} (A) Max.
SDL0806-R56MF	0.56 $\pm 20\%$	1.0V / 100K	1.90	23	28
SDL0806-R82MF	0.82 $\pm 20\%$	1.0V / 100K	2.90	18	23
SDL0806-1R2MF	1.20 $\pm 20\%$	1.0V / 100K	4.30	15	21

7. INDUCTANCE VS. DC BIAS CURVES :

SDL0806-R56MF

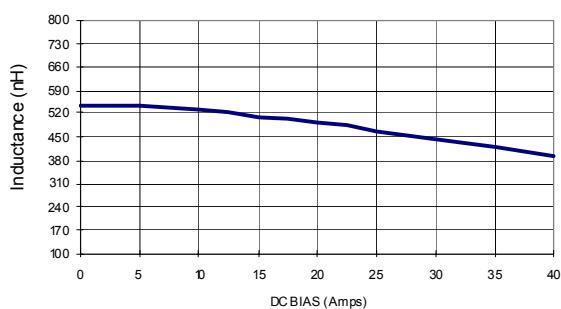

SDL0806-R82MF

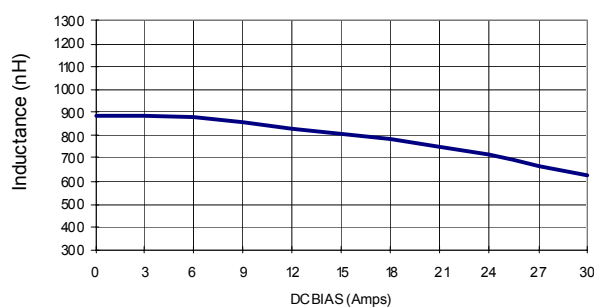

SDL0806-1R2MF

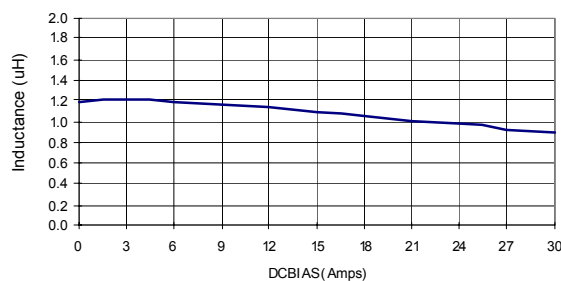

RoHS Compliant

NOTE : Specifications subject to change without notice. Please check our website for latest information.

05.05.2008



SUPERWORLD ELECTRONICS (S) PTE LTD

8. TEMPERATURE RISE VS DC BIAS CURVES : :

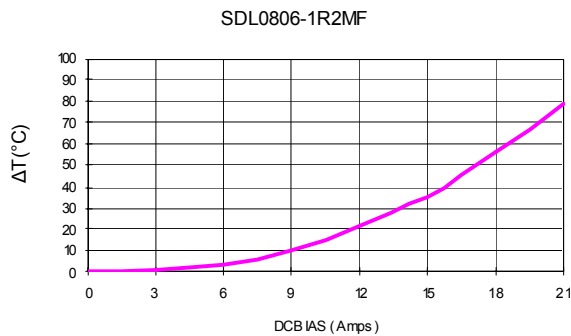
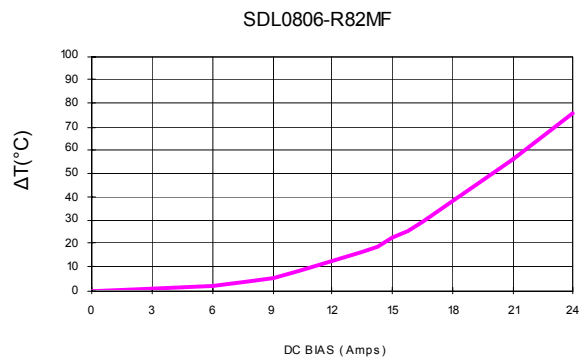
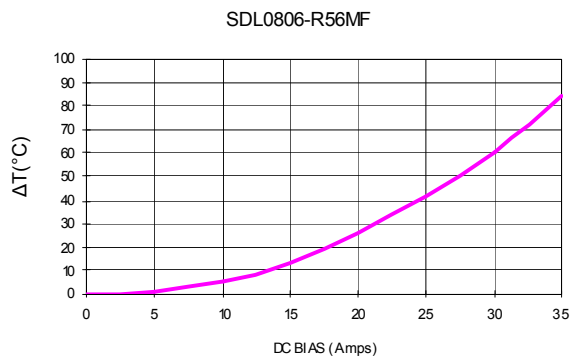

RoHS Compliant

NOTE : Specifications subject to change without notice. Please check our website for latest information.

05.05.2008



SUPERWORLD ELECTRONICS (S) PTE LTD