



N-Channel Enhancement Mode Field Effect Transistor

PRODUCT SUMMARY

V _{DSS}	I _D	R _{DS(ON)} (Ω) Typ
650V	4A	2.3 @ V _{GS} =10V

FEATURES

- Super high dense cell design for low R_{DS(ON)}.
- Rugged and reliable.
- TO-220 and TO-220F Package.

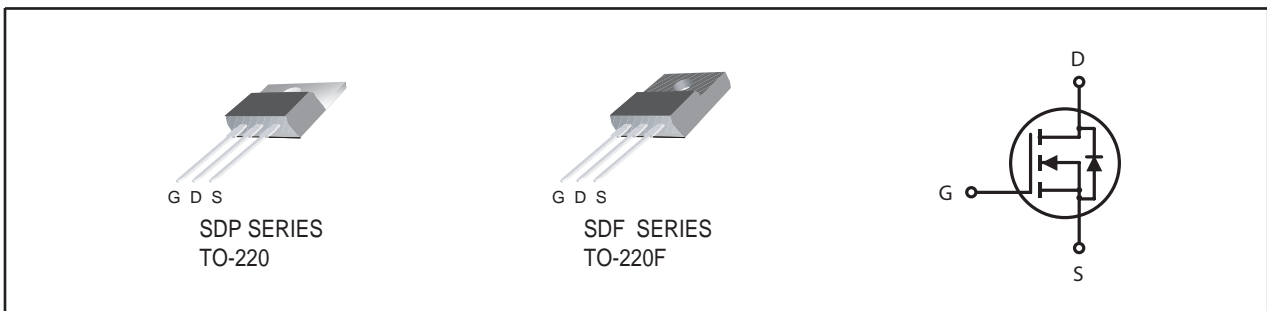

ORDERING INFORMATION

Ordering Code	Package	Marking Code	Delivery Mode	RoHS Status
SDP04N65HZ	TO-220	SDP04N65	Tube	Halogen Free
SDP04N65PZ	TO-220	04N65	Tube	Pb Free
SDF04N65HZ	TO-220F	SDF04N65	Tube	Halogen Free
SDF04N65PZ	TO-220F	04N65	Tube	Pb Free

ABSOLUTE MAXIMUM RATINGS (T_C=25°C unless otherwise noted)

Symbol	Parameter	SDP04N65	SDF04N65	Units
V _{DS}	Drain-Source Voltage	650		V
V _{GS}	Gate-Source Voltage	±30	±30	V
I _D	Drain Current-Continuous ^a	T _C =25°C	4	4
		T _C =100°C	2.8	2.8
I _{DM}	-Pulsed ^a	12	12	A
E _{AS}	Single Pulse Avalanche Energy ^c	324		mJ
P _D	Maximum Power Dissipation	T _C =25°C	94	31
		T _C =100°C	47	15.6
T _J , T _{STG}	Operating Junction and Storage Temperature Range	-55 to 175		°C

THERMAL CHARACTERISTICS

Symbol	Parameter	SDP04N65	SDF04N65	Units
R _{θJC}	Thermal Resistance, Junction-to-Case	1.6	4.8	°C/W
R _{θJA}	Thermal Resistance, Junction-to-Ambient	62.5	62.5	°C/W

SDP04N65

SDF04N65

Ver 2.2

ELECTRICAL CHARACTERISTICS (T_C=25°C unless otherwise noted)

Symbol	Parameter	Conditions	Min	Typ	Max	Units
OFF CHARACTERISTICS						
BV _{DSS}	Drain-Source Breakdown Voltage	V _{GS} =0V , I _D =250uA	650			V
I _{DSS}	Zero Gate Voltage Drain Current	V _{DS} =520V , V _{GS} =0V			1	uA
I _{GSS}	Gate-Body Leakage Current	V _{GS} = ±30V , V _{DS} =0V			±100	nA
ON CHARACTERISTICS						
V _{GS(th)}	Gate Threshold Voltage	V _{DS} =V _{GS} , I _D =250uA	2	3	4	V
R _{DS(ON)}	Drain-Source On-State Resistance	V _{GS} =10V , I _D =2A		2.3	2.8	ohm
g _{FS}	Forward Transconductance	V _{DS} =20V , I _D =2A		2.9		S
DYNAMIC CHARACTERISTICS ^b						
C _{ISS}	Input Capacitance	V _{DS} =25V, V _{GS} =0V f=1.0MHz		500		pF
C _{OSS}	Output Capacitance			57		pF
C _{RSS}	Reverse Transfer Capacitance			14		pF
SWITCHING CHARACTERISTICS ^b						
t _{D(ON)}	Turn-On Delay Time	V _{DD} =325V I _D =1A V _{GS} =10V R _{GEN} = 6 ohm		20		ns
t _r	Rise Time			17		ns
t _{D(OFF)}	Turn-Off Delay Time			24		ns
t _f	Fall Time			11		ns
Q _g	Total Gate Charge	V _{DS} =325V, I _D =1A, V _{GS} =10V		11.5		nC
Q _{gs}	Gate-Source Charge	V _{DS} =325V, I _D =1A, V _{GS} =10V		2		nC
Q _{gd}	Gate-Drain Charge			5.3		nC
DRAIN-SOURCE DIODE CHARACTERISTICS AND MAXIMUM RATINGS						
V _{SD}	Diode Forward Voltage	V _{GS} =0V, I _S =1A		0.77	1.4	V
Notes						
<p>a. Drain current limited by maximum junction temperature.</p> <p>b. Guaranteed by design, not subject to production testing.</p> <p>c. Starting T_J=25°C, L=50mH, V_{DD} = 50V. (See Figure 12)</p>						

Dec, 24, 2013

SDP04N65

SDF04N65

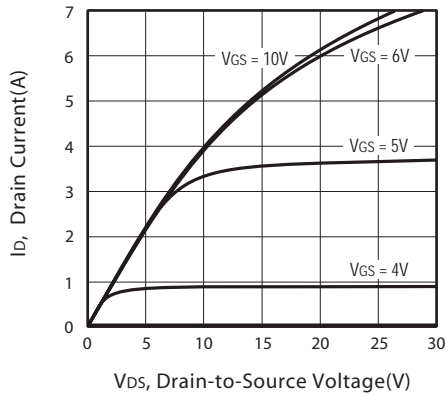

Figure 1. Output Characteristics

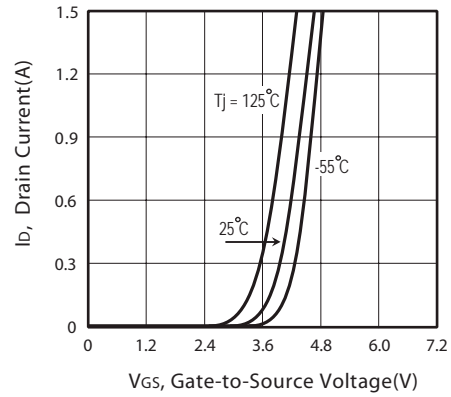

Figure 2. Transfer Characteristics

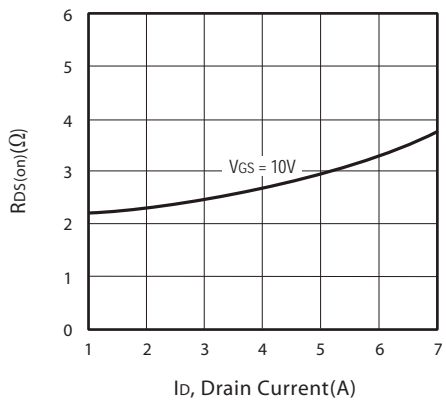

Figure 3. On-Resistance vs. Drain Current and Gate Voltage

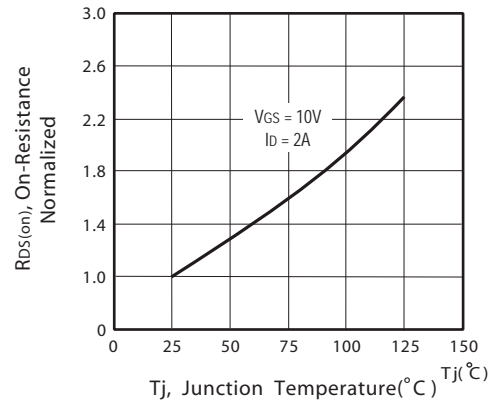

Figure 4. On-Resistance Variation with Drain Current and Temperature

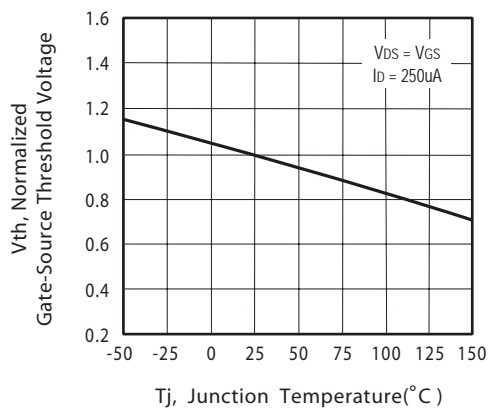

Figure 5. Gate Threshold Variation with Temperature

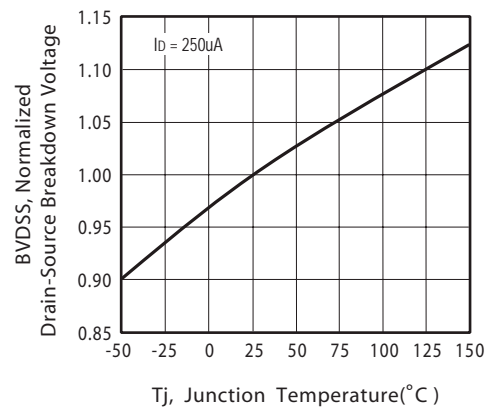

Figure 6. Breakdown Voltage Variation with Temperature

SDP04N65

SDF04N65

Ver 2.2

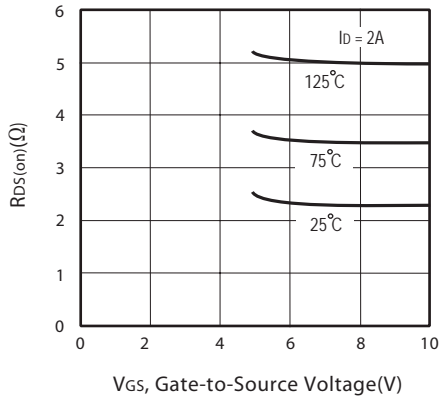

Figure 7. On-Resistance vs. Gate-Source Voltage

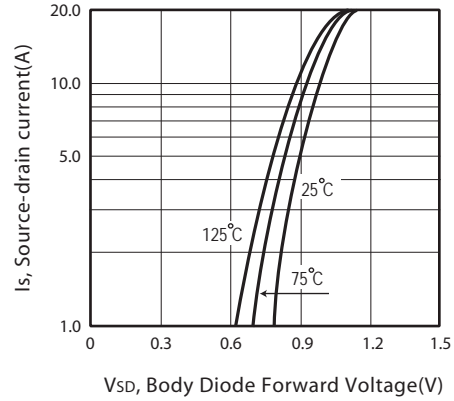

Figure 8. Body Diode Forward Voltage Variation with Source Current

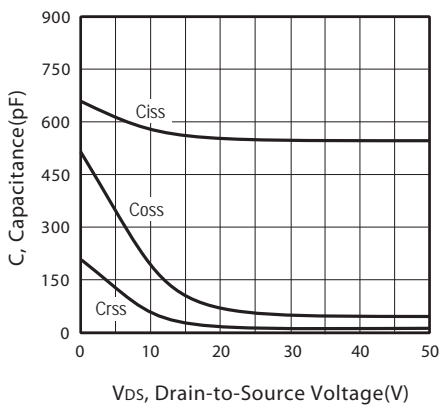

Figure 9. Capacitance

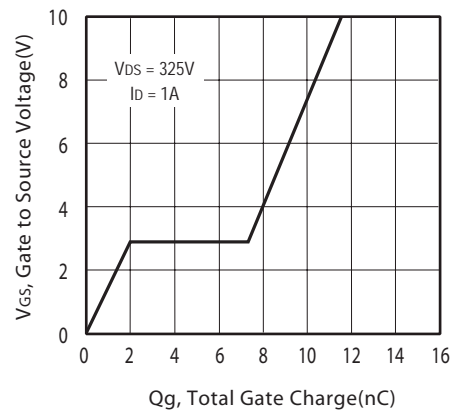

Figure 10. Gate Charge

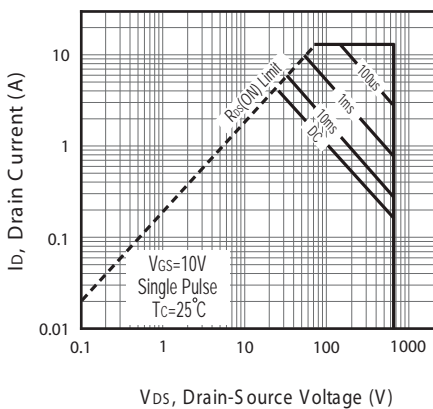

Figure 11a. Maximum Safe Operating Area for SDP04N65

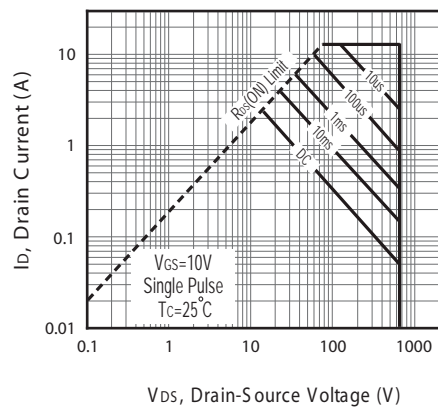

Figure 11b. Maximum Safe Operating Area for SDF04N65

Dec.24,2013

SDP04N65

SDF04N65

Ver 2.2

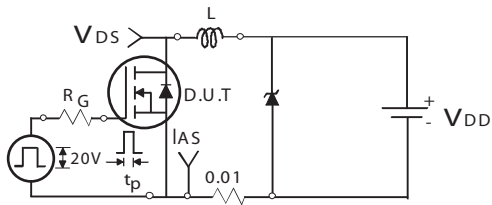

Unclamped Inductive Test Circuit

Figure 12a.

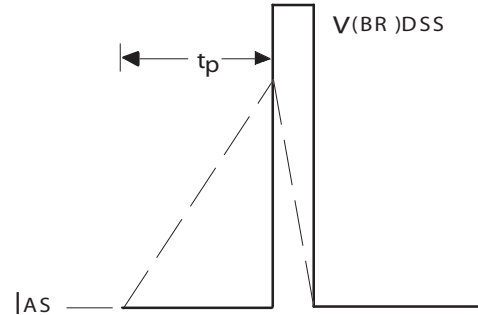

Unclamped Inductive Waveforms

Figure 12b.

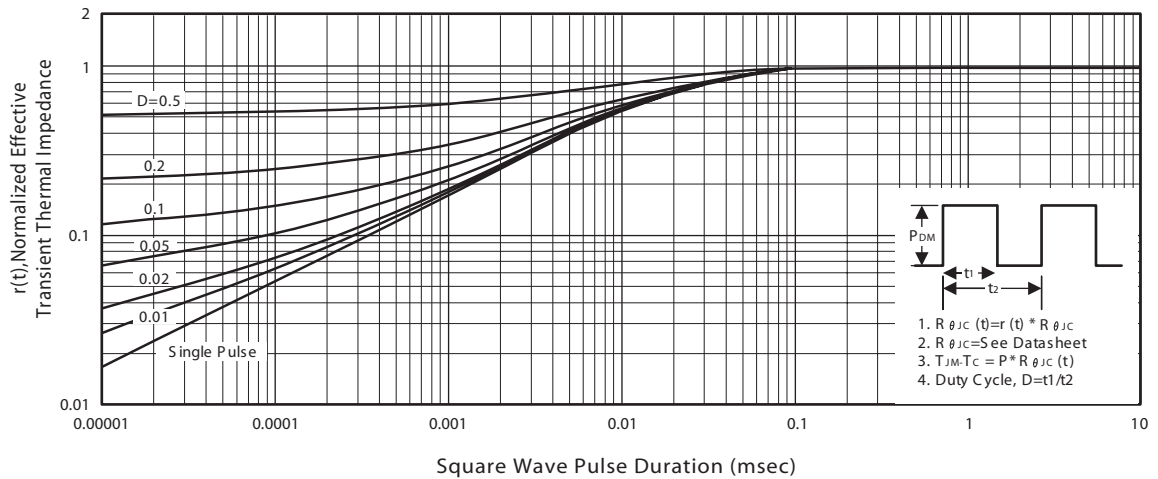

Figure 13a. Normalized Thermal Transient Impedance Curve for SDP04N65

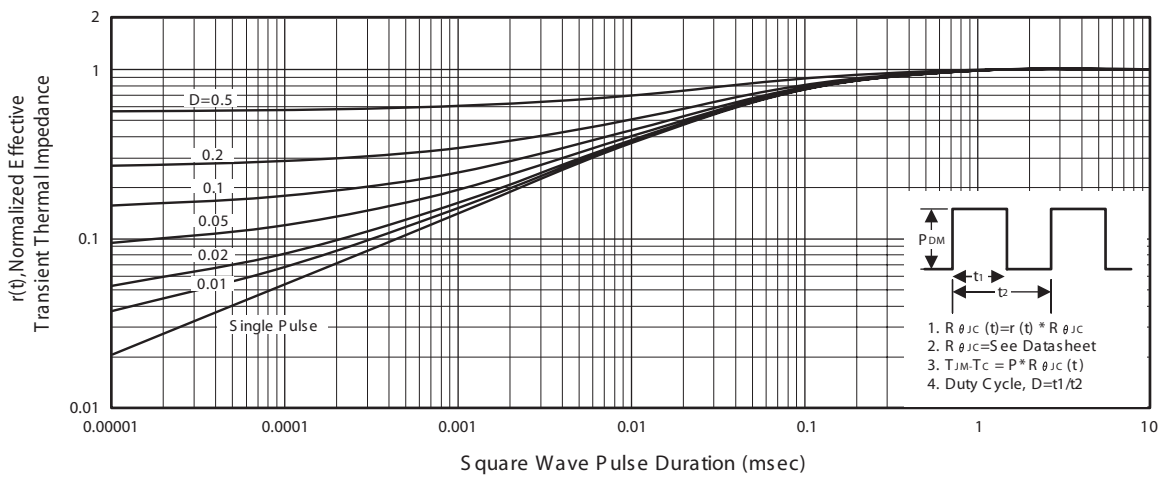

Figure 13b. Normalized Thermal Transient Impedance Curve for SDF04N65

Dec,24,2013

SDP04N65

SDF04N65

Ver 2.2

PACKAGE OUTLINE DIMENSIONS

TO-220

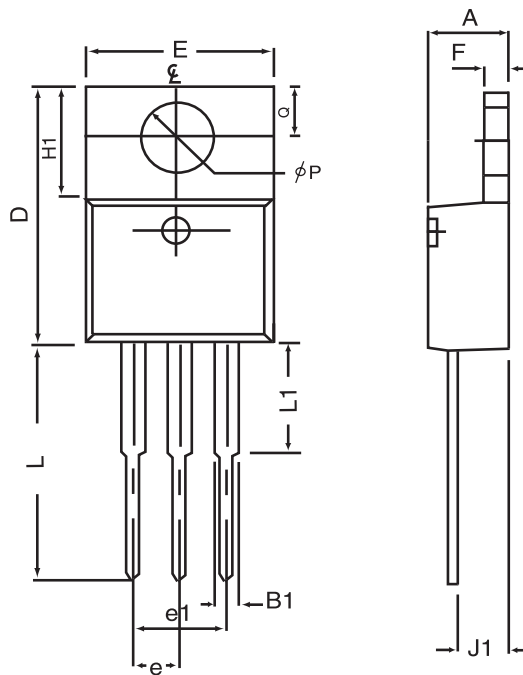

SYMBOLS	MILLIMETERS		INCHES	
	MIN	MAX	MIN	MAX
A	4.32	4.80	0.170	0.189
B1	1.27	1.65	0.050	0.630
D	14.6	16.00	0.575	0.610
E	9.70	10.41	0.382	0.410
e	2.34	2.74	0.092	0.108
e1	4.68	5.48	0.184	0.216
F	1.14	1.40	0.045	0.055
H1	5.97	6.73	0.235	0.265
J1	2.20	2.79	0.087	0.110
L	12.88	14.22	0.507	0.560
L1	3.00	6.35	0.120	0.250
phi P	3.50	3.94	0.138	0.155
Q	2.54	3.05	0.100	0.120

Dec,24,2013

SDP04N65

SDF04N65

Ver 2.2

PACKAGE OUTLINE DIMENSIONS

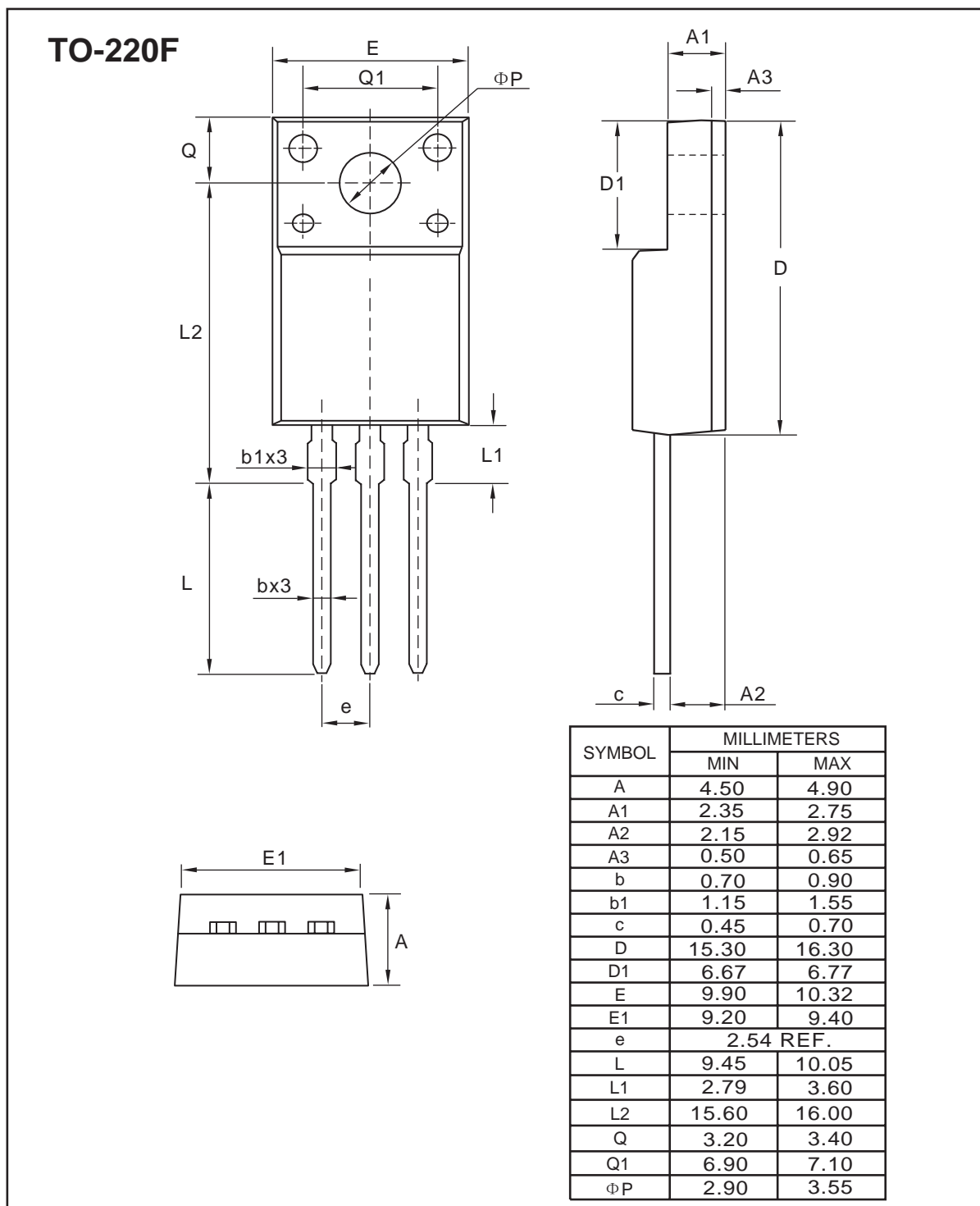

Dec,24,2013

SDP04N65

SDF04N65

Ver 2.2

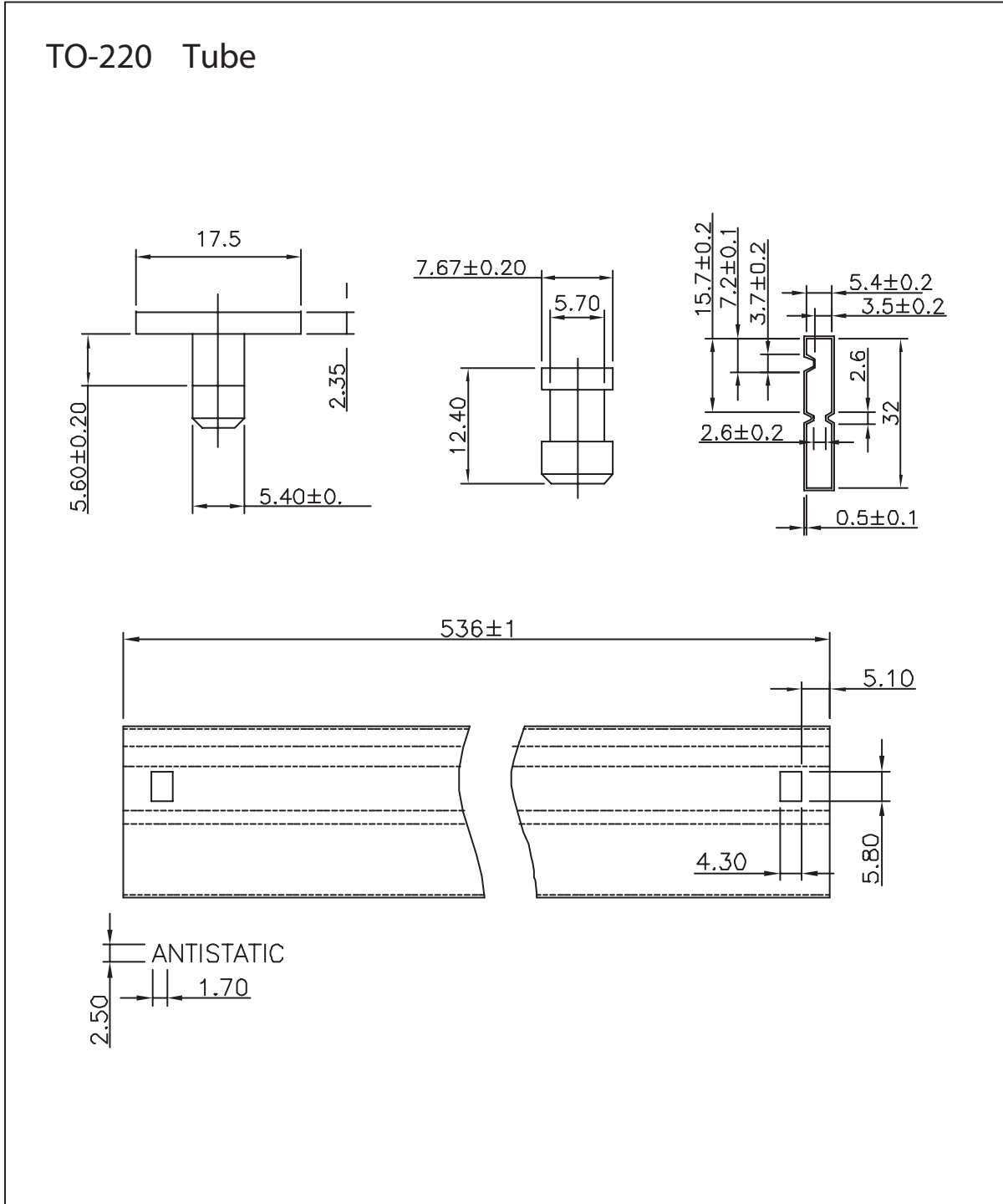

Dec,24,2013

SDP04N65 SDF04N65

Ver 2.2

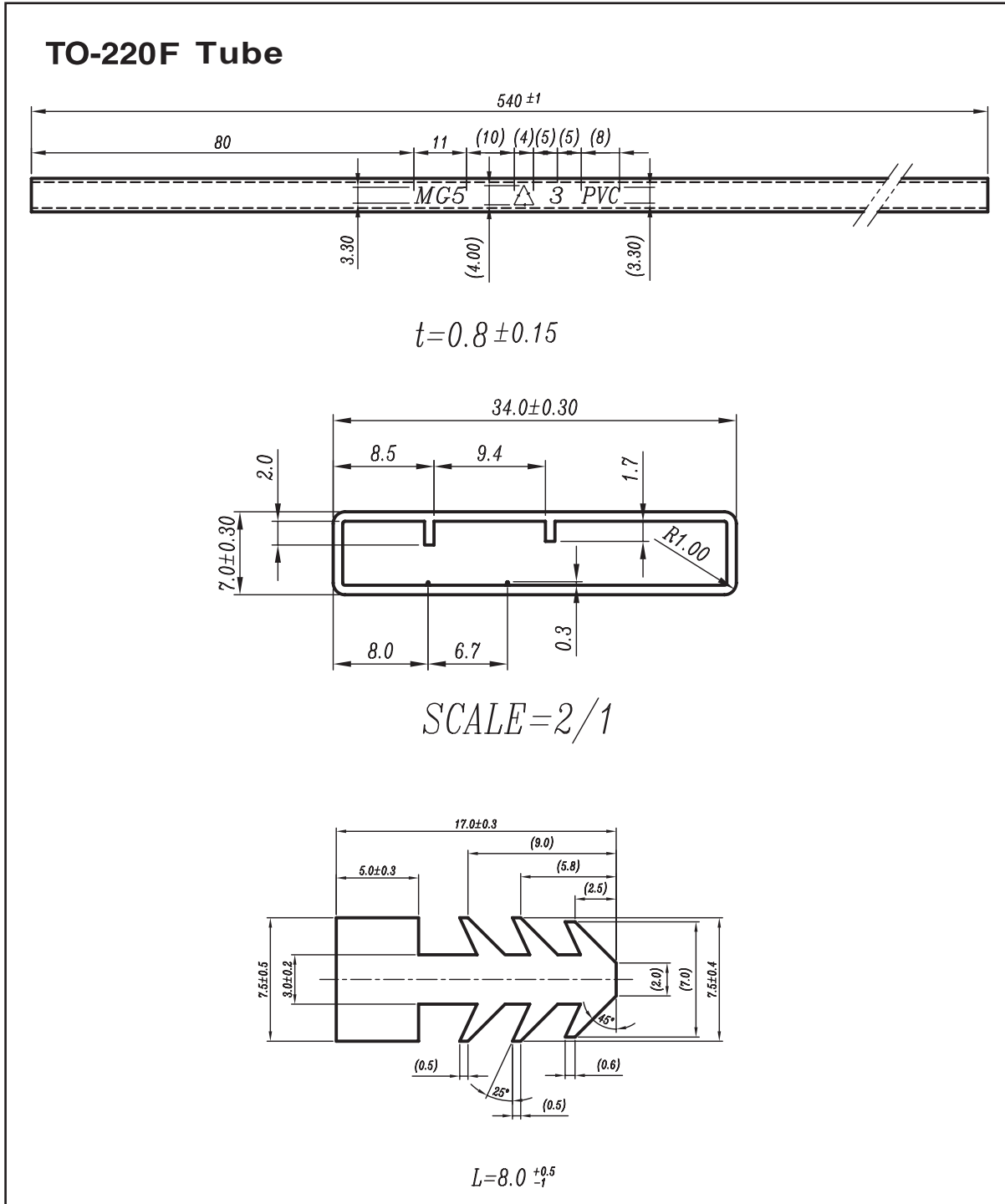

Dec, 24, 2013

SDP04N65

SDF04N65

Ver 2.2

TOP MARKING DEFINITION

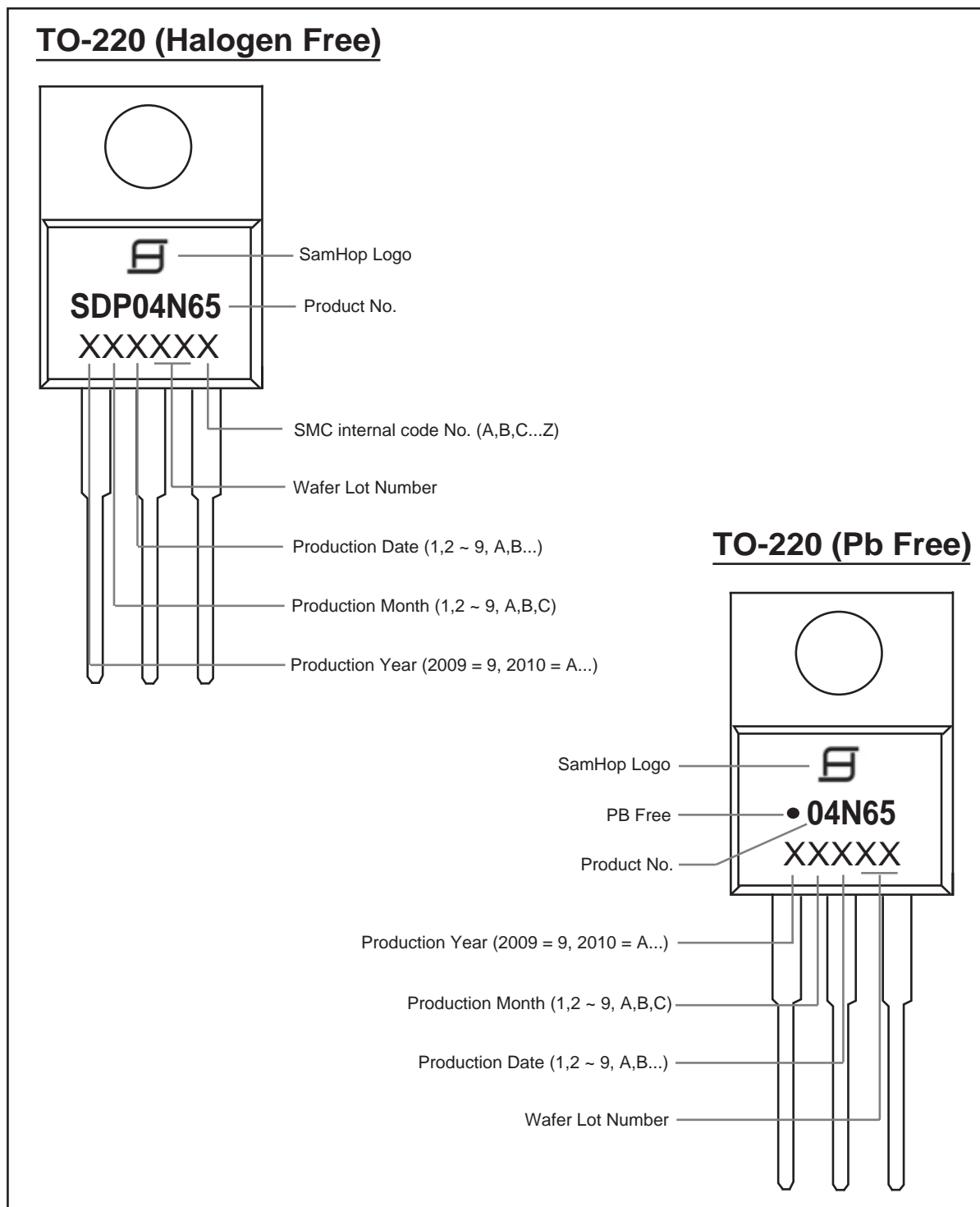

Dec,24,2013

SDP04N65

SDF04N65

Ver 2.2

TOP MARKING DEFINITION

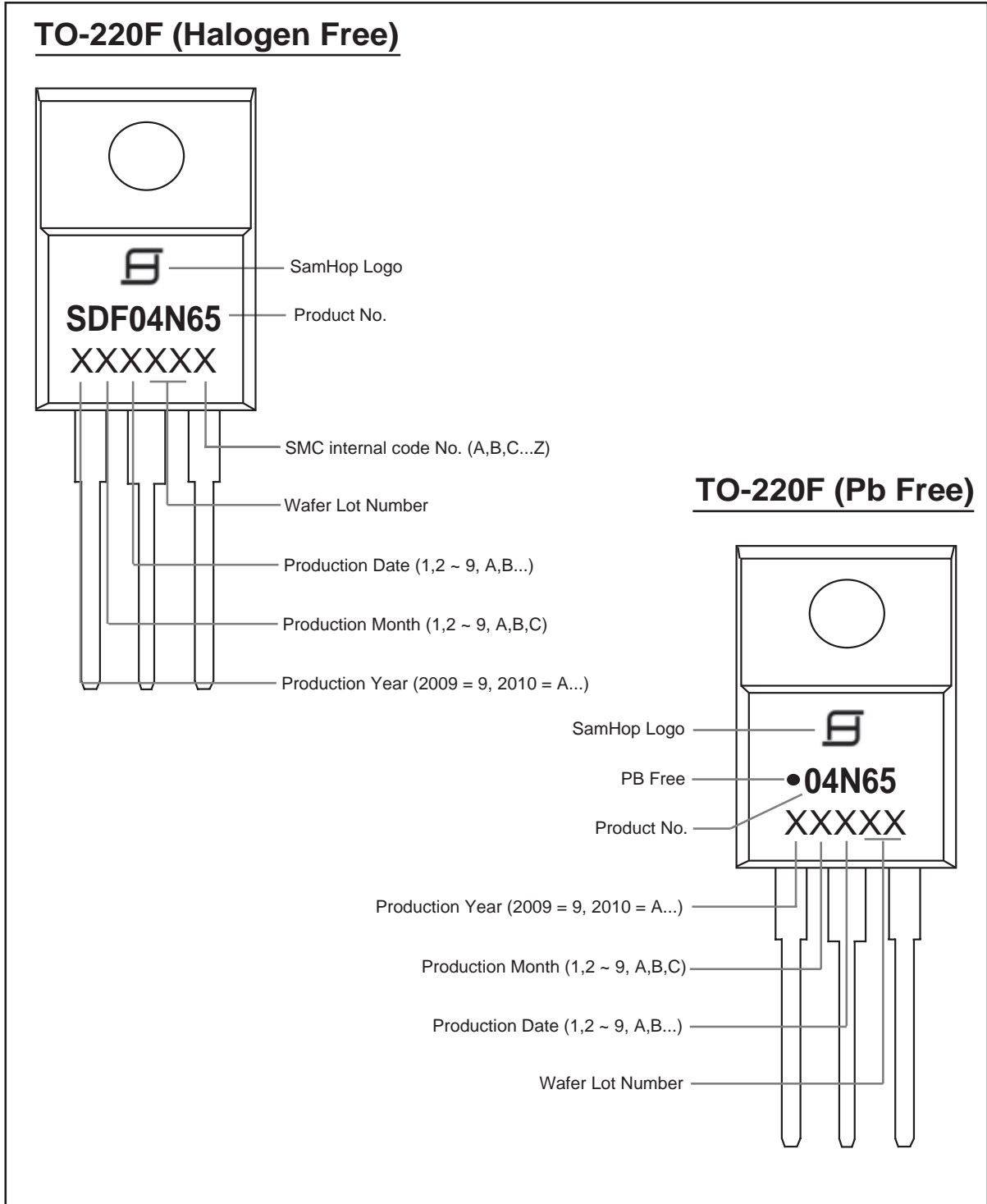

Dec,24,2013