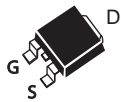
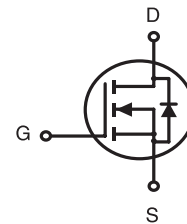

**N-Channel Logic Level Enhancement Mode Field Effect Transistor****PRODUCT SUMMARY**

V _{DSS}	I _D	R _{DS(ON)} (Ω) Max
600V	2A	4.7 @ V _{GS} =10V

FEATURES

- Super high dense cell design for low R_{DS(ON)}.
- Rugged and reliable.
- Surface Mount Package.

SDU SERIES
TO-252(D-PAK)SDD SERIES
TO-251S(I-PAK)SDD SERIES
TO-251L(I-PAK)**ORDERING INFORMATION**

Ordering Code	Package	Marking Code	Delivery Mode	RoHS Status
SDU02N60HZ	TO-252	SDU02N60	Reel	Halogen Free
SDD02N60HS	TO-251S	SDD02N60	Tube	Halogen Free
SDD02N60HL	TO-251L	SDD02N60	Tube	Halogen Free

ABSOLUTE MAXIMUM RATINGS (T_C=25°C unless otherwise noted)

Symbol	Parameter	Limit	Units	
V _{DS}	Drain-Source Voltage	600	V	
V _{GS}	Gate-Source Voltage	±30	V	
I _D	Drain Current-Continuous ^{a d}	T _C =25°C	2	A
		T _C =100°C	1.3	A
I _{DM}	-Pulsed ^b	5.8	A	
P _D	Maximum Power Dissipation	T _C =25°C	42	W
		T _C =100°C	17	W
T _J , T _{STG}	Operating Junction and Storage Temperature Range	-55 to 150	°C	

THERMAL CHARACTERISTICS

R _{θ JC}	Thermal Resistance, Junction-to-Case	3	°C/W
R _{θ JA}	Thermal Resistance, Junction-to-Ambient	50	°C/W

SDU/D02N60

Ver 2.2

ELECTRICAL CHARACTERISTICS (T_C=25°C unless otherwise noted)

Symbol	Parameter	Conditions	Min	Typ	Max	Units
OFF CHARACTERISTICS						
BV _{DSS}	Drain-Source Breakdown Voltage	V _{GS} =0V , I _D =250uA	600			V
I _{DSS}	Zero Gate Voltage Drain Current	V _{DS} =480V , V _{GS} =0V			1	uA
I _{GSS}	Gate-Body Leakage Current	V _{GS} = ±30V , V _{DS} =0V			±100	nA
ON CHARACTERISTICS						
V _{GS(th)}	Gate Threshold Voltage	V _{DS} =V _{GS} , I _D =250uA	2	3	4	V
R _{DS(ON)}	Drain-Source On-State Resistance	V _{GS} =10V , I _D =1A		3.6	4.7	ohm
g _{FS}	Forward Transconductance	V _{DS} =20V , I _D =1A		1.6		S
DYNAMIC CHARACTERISTICS °						
C _{ISS}	Input Capacitance	V _{DS} =25V, V _{GS} =0V f=1.0MHz		300		pF
C _{OSS}	Output Capacitance			37		pF
C _{RSS}	Reverse Transfer Capacitance			9		pF
SWITCHING CHARACTERISTICS °						
t _{D(ON)}	Turn-On Delay Time	V _{DD} =300V I _D =1A V _{GS} =10V R _{GEN} =6 ohm		17.5		ns
t _r	Rise Time			17		ns
t _{D(OFF)}	Turn-Off Delay Time			21		ns
t _f	Fall Time			8		ns
Q _g	Total Gate Charge		V _{DS} =300V, I _D =1A, V _{GS} =10V		7	
Q _{gs}	Gate-Source Charge	V _{DS} =300V, I _D =1A, V _{GS} =10V		1.5		nC
Q _{gd}	Gate-Drain Charge			2.9		nC
DRAIN-SOURCE DIODE CHARACTERISTICS AND MAXIMUM RATINGS						
V _{SD}	Diode Forward Voltage	V _{GS} =0V, I _S =1A		0.79	1.4	V
Notes a.Surface Mounted on FR4 Board,t ≤ 10sec. b.Pulse Test:Pulse Width ≤ 300us, Duty Cycle ≤ 2%. c.Guaranteed by design, not subject to production testing. d.Drain current limited by maximum junction temperature.						

Dec,24,2013

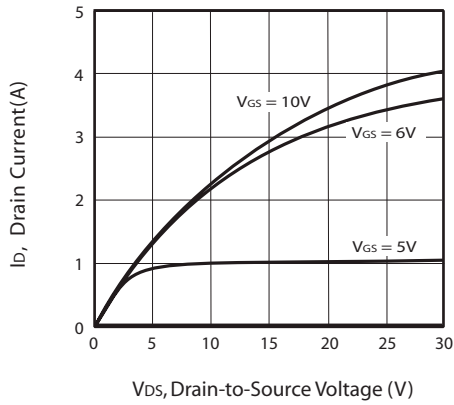

Figure 1. Output Characteristics

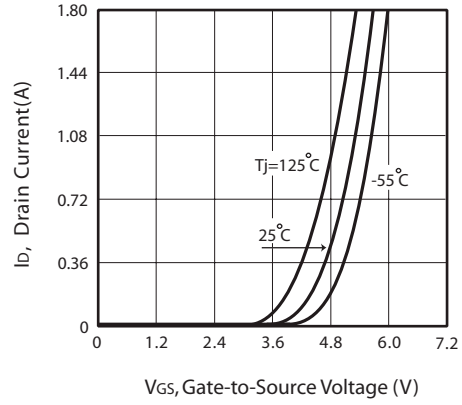

Figure 2. Transfer Characteristics

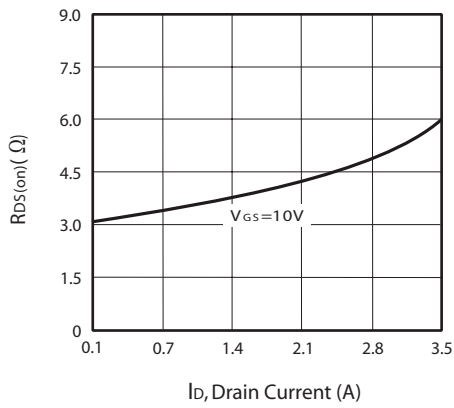

Figure 3. On-Resistance vs. Drain Current and Gate Voltage

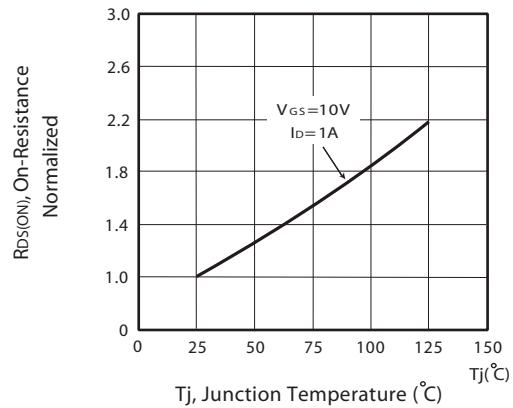

Figure 4. On-Resistance Variation with Drain Current and Temperature

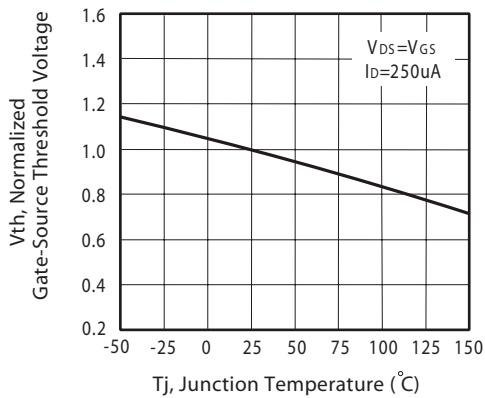

Figure 5. Gate Threshold Variation with Temperature

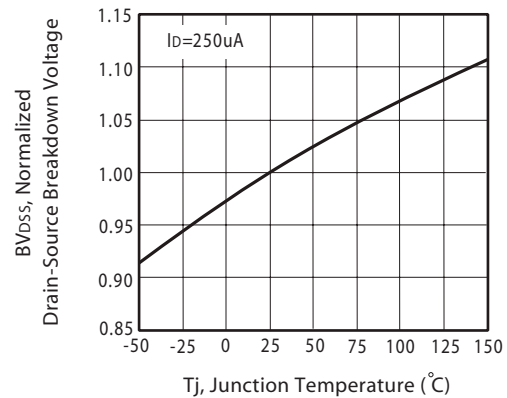

Figure 6. Breakdown Voltage Variation with Temperature

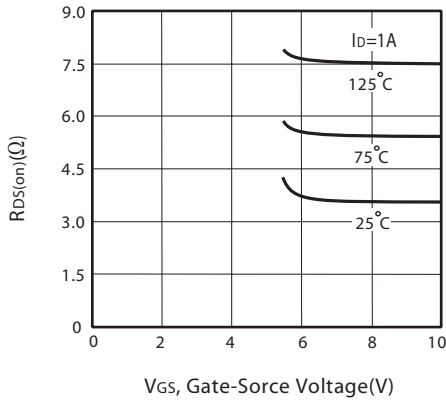

Figure 7. On-Resistance vs. Gate-Source Voltage

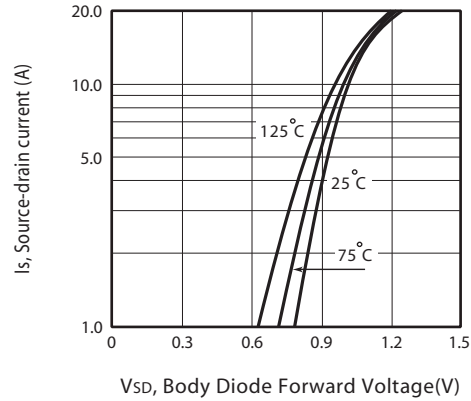

Figure 8. Body Diode Forward Voltage Variation with Source Current

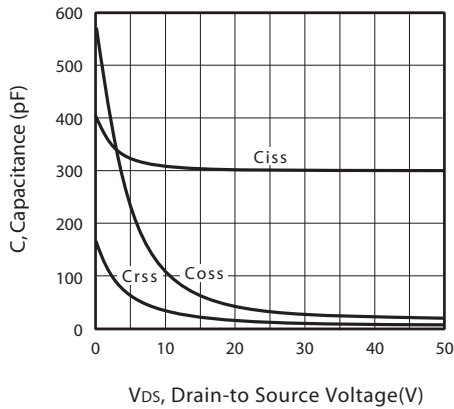

Figure 9. Capacitance

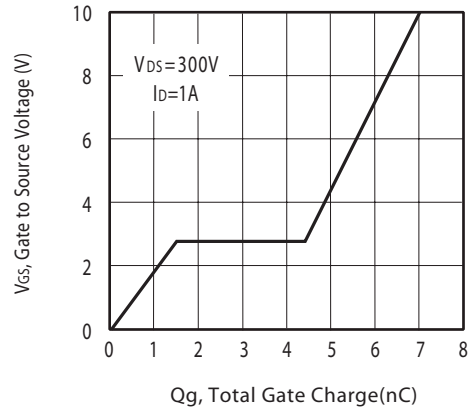

Figure 10. Gate Charge

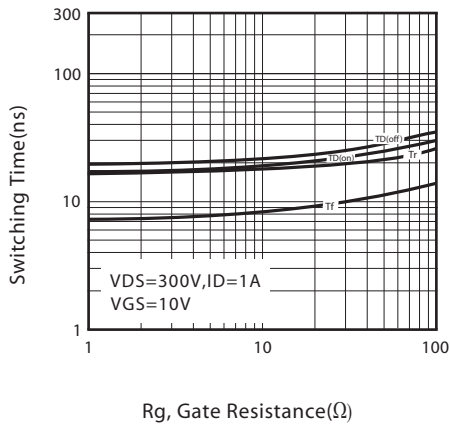

Figure 11. switching characteristics

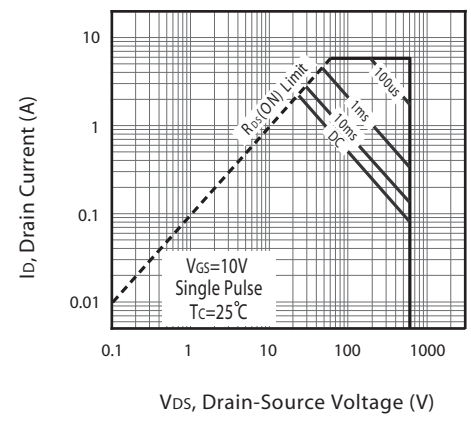
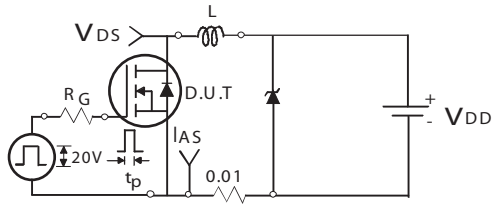

Figure 12. Maximum Safe Operating Area

SDU/D02N60

Ver 2.2



Unclamped Inductive Test Circuit

Figure 13a.

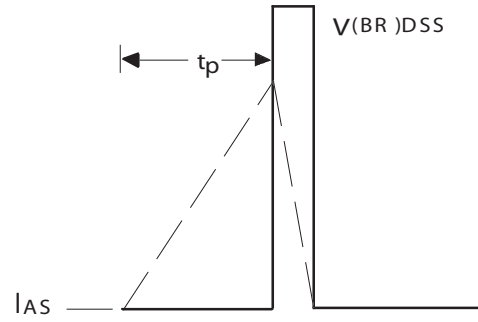

Unclamped Inductive Waveforms

Figure 13b.

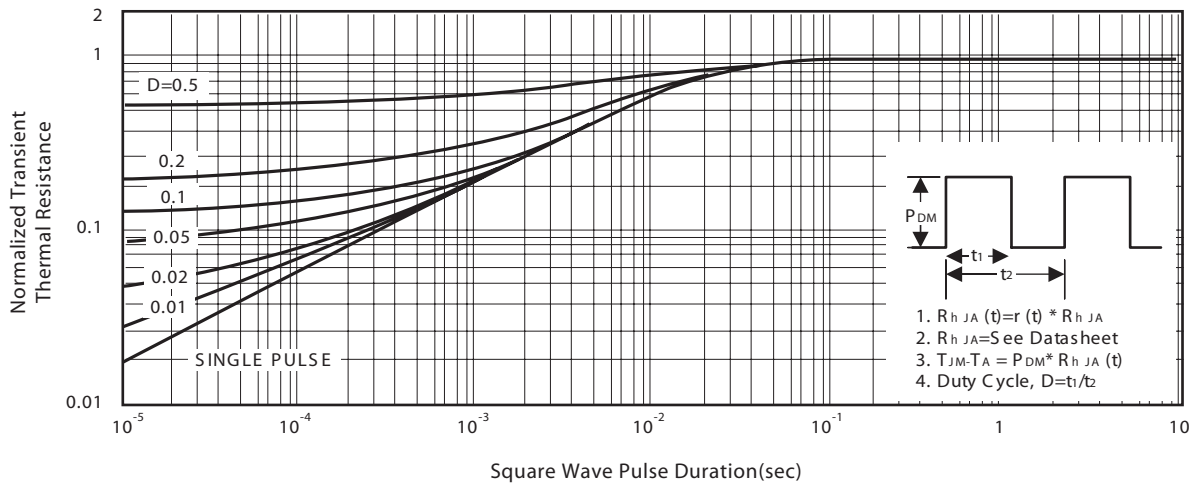

Figure 14. Normalized Thermal Transient Impedance Curve

Dec,24,2013

SDU/D02N60

Ver 2.2

TO-252

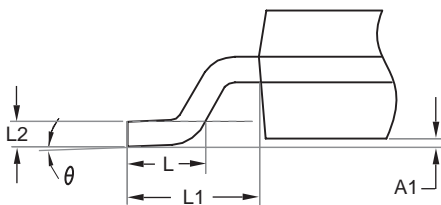
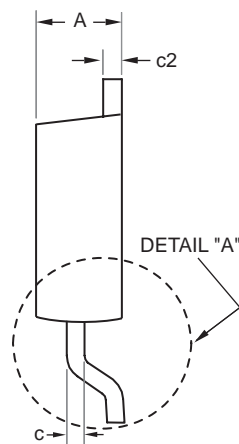
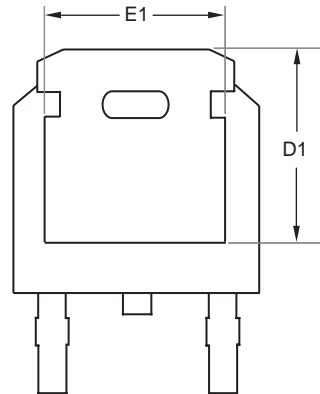
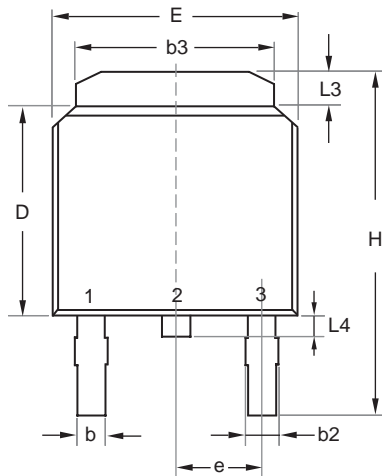

DETAIL "A"

SYMBOLS	MILLIMETERS	
	MIN	MAX
A	2.200	2.380
A1	0.000	0.127
b	0.635	0.889
b2	0.762	1.143
b3	5.200	5.460
c	0.450	0.600
c2	0.450	0.580
D	6.000	6.223
D1	5.210	5.380
e	2.286 BSC	
E	6.400	6.731
E1	4.318	4.900
H	9.400	10.400
L	1.400	1.770
L1	2.743 REF	
L2	0.508 BSC	
L3	0.890	1.270
L4	0.640	1.010
θ	0°	10°

Dec,24,2013

PACKAGE OUTLINE DIMENSIONS

TO-251S

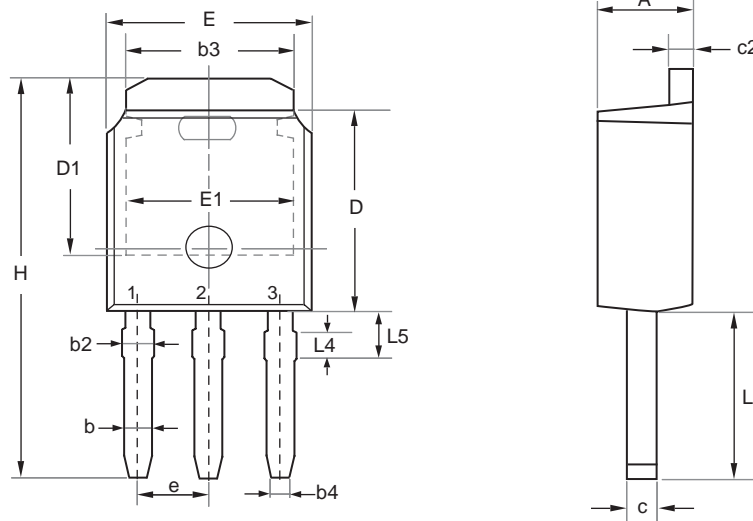

SYMBOL	MILLIMETERS	
	MIN	MAX
E	6.350	6.731
L	3.700	4.400
L4	0.698 REF	
L5	0.972	1.226
D	5.970	6.223
H	9.670	11.450
b	0.630	0.850
b2	0.760	1.140
b3	4.950	5.460
b4	0.450	0.550
e	2.286 BSC	
A	2.180	2.390
c	0.400	0.610
c2	0.400	0.610
D1	5.100	---
E1	4.318	---

PACKAGE OUTLINE DIMENSIONS

TO-251L

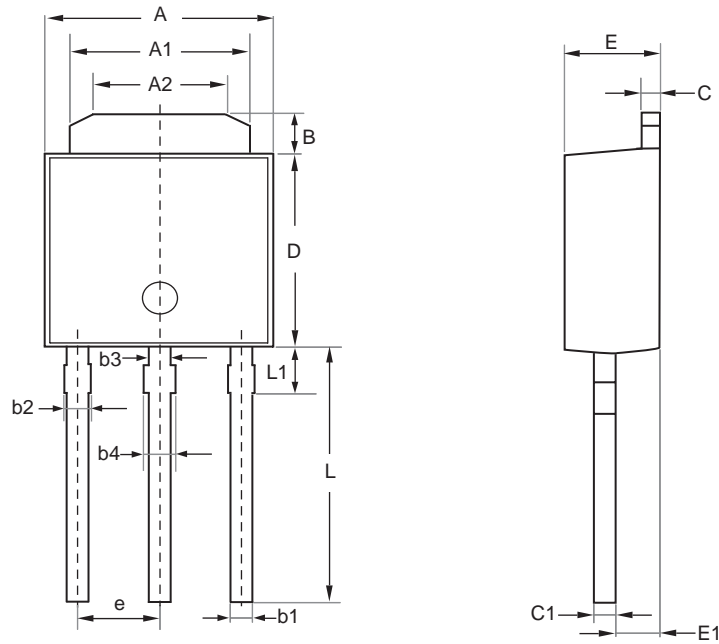

SYMBOL	MILLIMETERS		
	MIN	NOM	MAX
A	6.40	6.50	6.60
A1	5.30	5.40	5.50
A2	4.30	4.40	4.50
B	1.35	1.50	1.65
L1	1.55 REF		
L	7.40	7.70	8.00
D	5.40	5.55	5.70
C	0.55	0.60	0.65
C1	0.49	0.54	0.59
E1	1.72	1.77	1.82
E	2.20	2.30	2.40
b1	0.60	—	0.75
b2	0.70	—	0.85
b3	0.80		
b4	0.90		
e	2.30		

TO-251 Tube/TO-252 Tape and Reel Data

TO-251 Tube

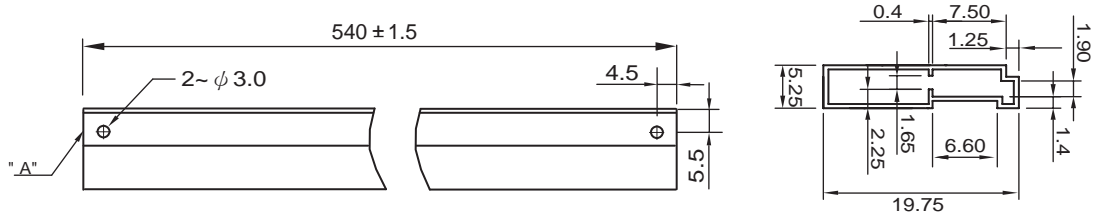

TO-252 Carrier Tape

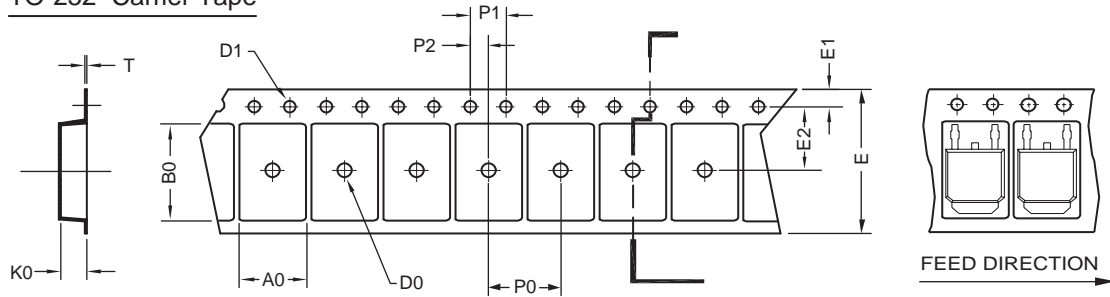

UNIT:mm

PACKAGE	A0	B0	K0	D0	D1	E	E1	E2	P0	P1	P2	T
TO-252 (16 mm)	6.96 ±0.1	10.49 ±0.1	2.79 ±0.1	φ 2	φ 1.5 +0.1 - 0	16.0 ±0.3	1.75 ±0.1	7.5 ±0.15	8.0 ±0.1	4.0 ±0.1	2.0 ±0.15	0.3 ±0.05

TO-252 Reel

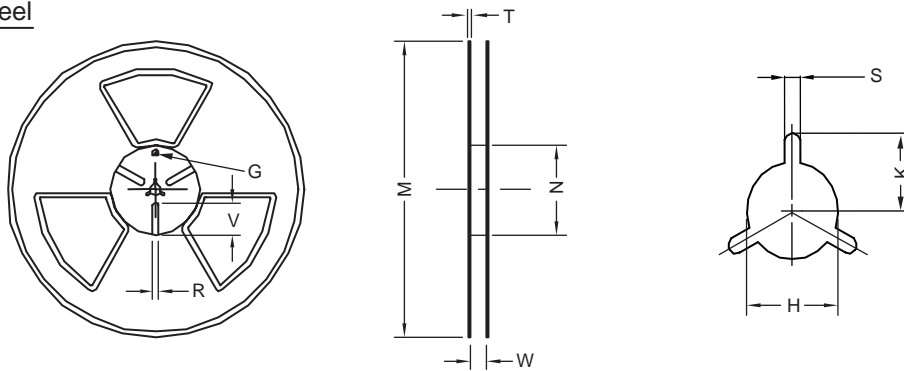

UNIT:mm

TAPE SIZE	REEL SIZE	M	N	W	T	H	K	S	G	R	V
16 mm	φ 330	φ 330 ± 0.5	φ 97 ± 1.0	17.0 + 1.5 - 0	2.2	φ 13.0 + 0.5 - 0.2	10.6	2.0 ±0.5	---	---	---

SDU/D02N60

Ver 2.2

TOP MARKING DEFINITION

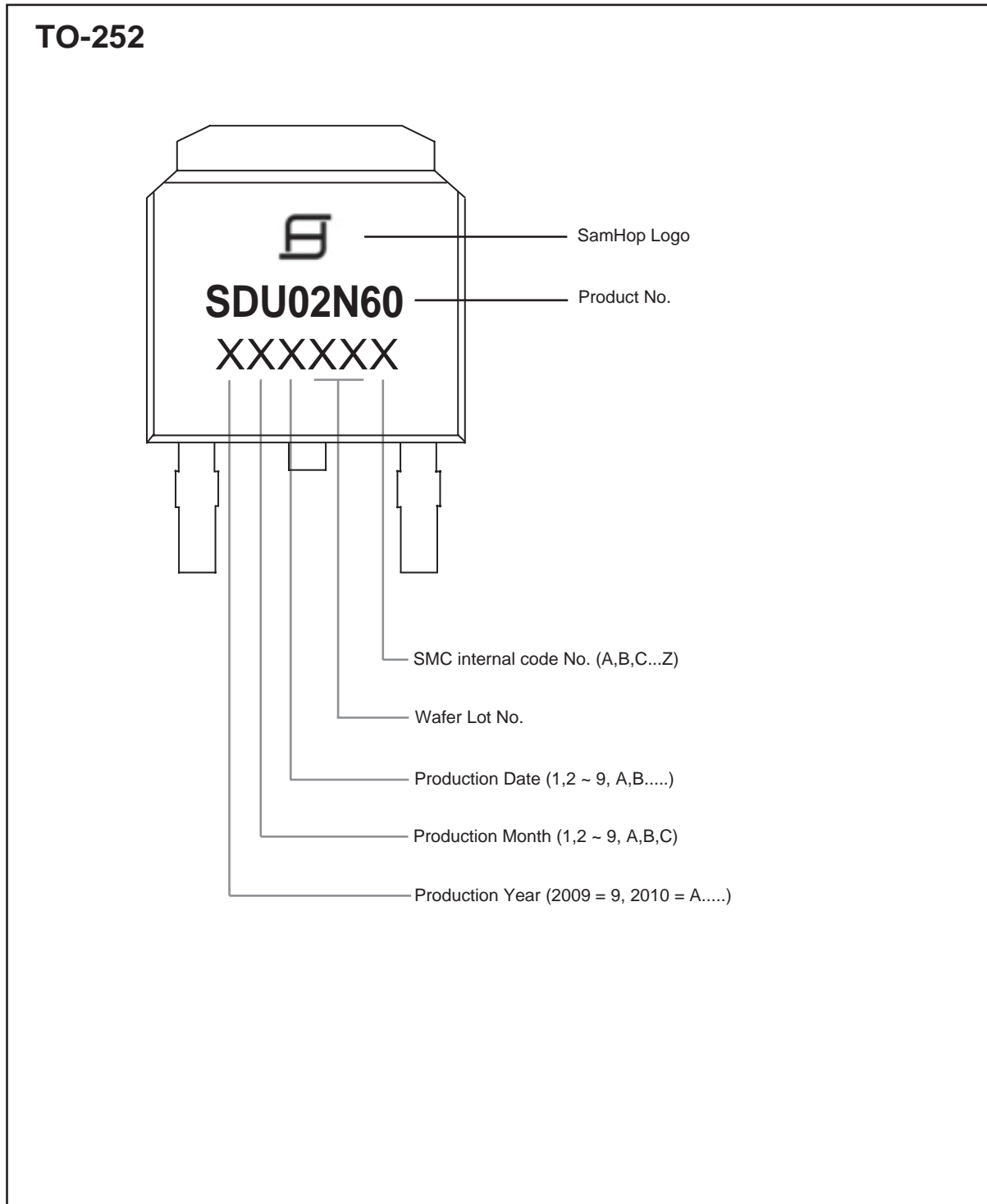

Dec,24,2013

TOP MARKING DEFINITION

