

Applications

- DSSS 2.4GHz WLAN (IEEE802.11b)
- OFDM 2.4GHz WLAN (IEEE802.11g)
- Access Points, PCMCIA, PC cards

Features

- +19 dBm, EVM = 2.7%, 802.11g, OFDM 54 Mbps
- +23 dBm, ACPR < -32 dB, 802.11b
- +25.5 dBm P_{1dB} at 3.3 V
- Selectable integrated external or internal coupled temperature compensated power detector
- Selectable Power Detector Slope for use with multiple chipsets (Negative and Positive)
- Integrated power amplifier enable pin (V_{EN})
- Single supply voltage: 2.7 to 3.6 V
- Lead free and RoHS Compliant
- Small plastic package, 16 pin 4 mm x 4 mm QFN

Ordering Information

Type	Package	Remark
SE2525L	16 Pin QFN	Samples
SE2525L-R	16 Pin QFN	Tape and Reel
SE2525L-EK1	Evaluation Kit	Standard

Product Description

The SE2525L is a 2.4GHz power amplifier designed for use in the 2.4GHz ISM band for wireless LAN applications. The device incorporates two selectable power detectors for closed loop monitoring of the output power.

For wireless LAN applications, the device meets the requirements of 802.11g and delivers +19 dBm, at an EVM of 2.7% and current of 160 mA @ 3.3 V.

The SE2525L's bias architecture provides for lower current consumption at lower output power levels. Also, the devices bias (V_B) control allows for further minor customization of the bias current for power saving at lower output powers.

The SE2525L includes a digital enable control for device on/off control.

The SE2525L has two selectable power detectors. The internally coupled signal is selected by grounding the V_{DETIN}/DET_{SEL} pin. This detector detects signal at the second stage improving the accuracy under output mismatch conditions. The second detector uses an external RF input pin which would typically be taken from a directional coupler output. Both detectors are temperature compensated for minimum component count and high accuracy. Each of these power detectors also have selectable positive and negative slopes for ease of use with all chipsets.

Please note this device is not recommended for new designs. SiGe's SE2528L is a pin for pin compatible device and can be used in existing SE2525L application boards with only component value changes. Application notes are available to assist in the change.

Functional Block Diagram

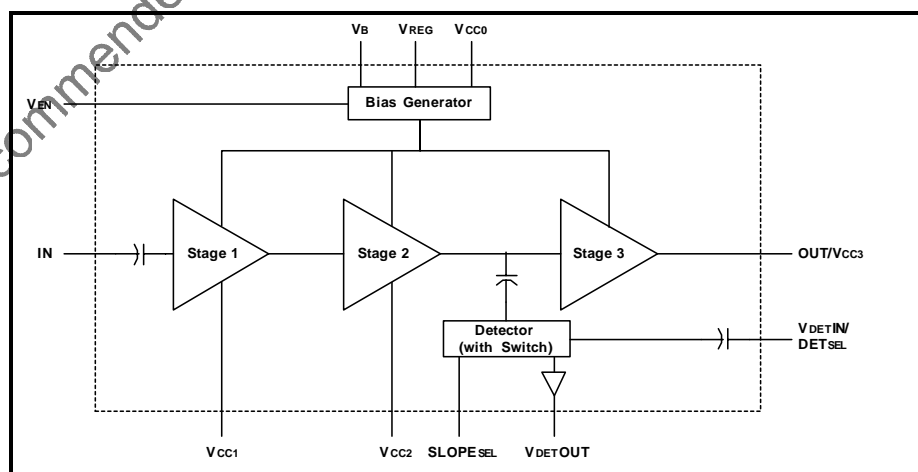

Figure 1: Functional Block Diagram

Pin Out Diagram

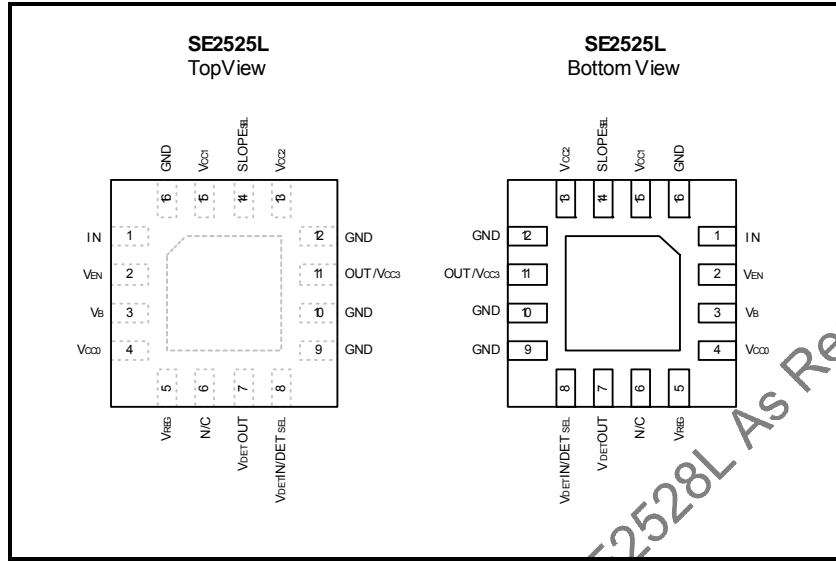

Figure 2: SE2525L Pin-Out Diagram

Pin Out Description

Pin No.	Name	Description
1	IN	Power amplifier RF input; DC block required.
2	VEN	Digital pin used to power up and power down the IC
3	VB	Controls the bias level of the power amplifier
4	VCC0	Bias/control circuit supply voltage
5	VREG	Internal regulator output
6	N/C	No Connect (Do not attach to GND or Vcc)
7	VDET OUT	Analog power detector output
8	VDET IN/DETSEL	Power Detector Input
9 -10	GND	Ground
11	OUT/ VCC3	Power Amplifier RF output and Stage 3 collector supply voltage
12	GND	Ground
13	VCC2	Stage 2 collector supply
14	SLOPESEL	Slope Select (N/C = Positive, GND = Negative)
15	VCC1	Stage 1 collector supply
16	GND	Ground
Die Pad	GND	Exposed die pad; electrical and thermal ground

Absolute Maximum Ratings

These are stress ratings only. Exposure to stresses beyond these maximum ratings for a long period of time may cause permanent damage to, or affect the reliability of the device. Avoid operating the device outside the recommended operating conditions defined below. This device is ESD sensitive. Handling and assembly of this device should be at ESD protected workstations.

Symbol	Definition	Min.	Max.	Unit
V _{CC}	Supply Voltage on pins V _{CC0} , V _{CC1} , V _{CC2} and V _{CC3}	-0.3	4.0	
V _B	Bias Control Voltage	-0.3	4.0	V
V _{EN}	Power Amplifier Enable	-0.3	4.0	V
IN	RF Input Power	-	4.0	dBm
T _{STG}	Storage Temperature Range	-40	+150	°C
T _j	Maximum Junction Temperature	-	+150	°C

Recommended Operating Conditions

Symbol	Parameter	Min.	Max.	Unit
V _{CC}	Supply Voltage on pins V _{CC0} , V _{CC1} , V _{CC2} and V _{CC3}	2.7	3.6	V
T _A	Ambient Temperature	-40	85	°C

DC Electrical Characteristics

Conditions: V_{CC} = V_{EN} = 3.3 V, V_B connected to V_{REG}, T_A = 25 °C, as measured on SiGe Semiconductor's SE2525L-EV1 evaluation board, unless otherwise noted.

Symbol	Parameter	Conditions	Min.	Typ.	Max.	Unit
I _{CC-802.11b}	Supply Current	P _{OUT} = 23 dBm, 11 Mbps CCK signal, BT = 0.45	-	230	-	mA
I _{CC-802.11g}	Supply Current	P _{OUT} = 19 dBm, 54 Mbps OFDM signal, 64 QAM	-	160	-	mA
I _{CC-1DB}	Supply Current	P _{OUT} = P _{1dB} , No modulation	-	340	-	mA
I _{OFF}	Supply Current	V _{EN} = 0 V	-	10	-	μA
V _{REG}	Regulator Voltage	I _{REG} = 120 μA ⁽¹⁾	-	2.5	2.75	V
I _{REG}	Regulator current	-	-	-	500	μA
V _{ENH}	Logic High Voltage	T _A = -40 to 85 °C, V _{CC} = 2.7 to 3.6 V	1.3	-	V _{CC}	V
V _{ENL}	Logic Low Voltage	T _A = -40 to 85 °C, V _{CC} = 2.7 to 3.6 V	0	-	0.5	V
V _B	Bias voltage	-	0	-	V _{REG}	V
I _B	Bias current	V _B = 2.75 V	-	-	120	μA

(1) No coupling or circuitry that provides a DC path to ground should be connected to the V_{REG} pin. Connection to the V_B is allowed.

AC Electrical Characteristics

802.11g AC Electrical Characteristics

Conditions: $V_{CC} = V_{EN} = 3.3\text{ V}$, $f = 2.45\text{ GHz}$, V_B connected to V_{REG} , $T_A = 25\text{ }^\circ\text{C}$, as measured on SiGe Semiconductor's SE2525L-EV1 evaluation board, unless otherwise noted

Symbol	Parameter	Conditions	Min.	Typ.	Max.	Unit
f _{L-U}	Frequency Range	-	2400	-	2500	MHz
P _{1dB}	Output 1dB compression point	No modulation	-	25.5	-	dBm
S ₂₁	Small Signal Gain	P _{IN} = -25 dBm	28	31	-	dB
ΔS ₂₁	Gain Variation over band	P _{IN} = -25 dBm, f _{IN} = 2400 to 2500 MHz	-	2	-	dB
2f	Harmonic	P _{OUT} = 23 dBm, CW	-	-27	-	dBm
3f			-	-46	-	dBm
EVM	Error Vector Magnitude	P _{OUT} = 19 dBm, 54 Mbps OFDM signal, 64 QAM	-	2.7	-	%
STAB	Stability	P _{IN} ≤ 2 dBm, P _{OUT} = 19 dBm, 54 Mbps OFDM signal, 64 QAM VSWR = 6:1 All Phases	All non-harmonically related outputs less than -50 dBc/100 kHz			
VSWR	Tolerance to output load mismatching	P _{IN} ≤ 2 dBm, P _{OUT} = 19 dBm, 54 Mbps OFDM signal, 64 QAM VSWR = 10:1 All Phases	No damage			

802.11b AC Electrical Characteristics

Conditions: $V_{CC} = V_{EN} = 3.3\text{ V}$, $f = 2.45\text{ GHz}$, V_B connected to V_{REG} , $T_A = 25\text{ }^\circ\text{C}$, as measured on SiGe Semiconductor's SE2525L-EV1 evaluation board, unless otherwise noted.

Symbol	Parameter	Conditions	Min.	Typ.	Max.	Unit
f_{L-U}	Frequency Range		2400		2500	MHz
P_{1dB}	Output 1dB compression point	No modulation	-	25.5	-	dBm
S_{21}	Small Signal Gain	$P_{IN} = -25\text{ dBm}$	28	31	-	dB
ΔS_{21}	Gain Variation over band	$P_{IN} = -25\text{ dBm}$, $f_{IN} = 2400\text{ to }2500\text{ MHz}$	-	2.0	-	dB
$2f$, $3f$	Harmonics	$P_{OUT} = 23\text{ dBm, CW}$	-	-27	-	dBm/MHz
			-	-47	-	dBm/MHz
ACPR	Adjacent Channel Power Ratio $\pm 11\text{ MHz}$ offsets from carrier $\pm 22\text{ MHz}$ offsets from carrier	$P_{OUT} = 23\text{ dBm}$, 11 Mbps CCK signal, BT = 0.45	-	-32 -52	-	dB
STAB	Stability	$P_{IN} \leq 2\text{ dBm}$, $P_{OUT} = 23\text{ dBm}$, 11 Mbps CCK signal, BT = 0.45, VSWR = 6:1	All non-harmonically related outputs less than -50 dBc/100 kHz			
VSWR	Tolerance to output load mismatching	$P_{IN} \leq 2\text{ dBm}$, $P_{OUT} = 23\text{ dBm}$, 11 Mbps CCK signal, BT = 0.45, VSWR = 10:1 All Phases	No damage			

Detector Selection Logic

Conditions: $V_{CC} = V_{EN} = 3.3\text{V}$, $V_B = V_{REG}$, $T_A = 25\text{ }^\circ\text{C}$, as measured on SiGe Semiconductor's SE2525L-EV1 evaluation board, unless otherwise noted

SLOPE _{SEL}	V _{DETIN/DETSEL}	Detector Slope	Detector Signal Source
Open Circuit	AC Coupled	Positive	External
Open Circuit	Ground	Positive	Internal
Ground	AC Coupled	Negative	External
Ground	Ground	Negative	Internal

Internal Coupled Power Detector

Internal Coupled Positive Slope

Conditions: $V_{CC} = V_{EN} = 3.3\text{ V}$, $f = 2.45\text{ GHz}$, V_B connected to V_{REG} , $SLOPE_{SEL} = \text{Open Circuit}$, $V_{DET\ IN/DET_{SEL}} = \text{GND}$, $T_A = 25\text{ }^\circ\text{C}$, as measured on SiGe Semiconductor's SE2525L-EV1 evaluation board, unless otherwise noted

Symbol	Parameter	Conditions	Min.	Typ.	Max.	Unit
PDR	P_{OUT} detect range	-	0	-	P_{1dB}	dBm
VDET	Detector voltage	$P_{OUT} = 23\text{ dBm}$	-	1.15	-	V
VDET	Detector voltage	$P_{OUT} = 19\text{ dBm}$	-	0.73	-	V
VDET	Detector voltage	$P_{OUT} = \text{NO RF}$	-	0.35	-	V
PDZ _{OUT}	Output Impedance	-	250	-	700	Ω
PDZ _{LOAD}	DC load impedance	-	10	-	-	k Ω

Internal Coupled Negative Slope

Conditions: $V_{CC} = V_{EN} = 3.3\text{ V}$, $f = 2.45\text{ GHz}$, V_B connected to V_{REG} , $V_{DET\ OUT}$ load = $2.4\text{ k}\Omega$ to ground, $SLOPE_{SEL} = \text{Open Circuit}$, $V_{DET\ IN/DET_{SEL}} = \text{GND}$, $T_A = 25\text{ }^\circ\text{C}$, as measured on SiGe Semiconductor's SE2525L-EV1 evaluation board, unless otherwise noted

Symbol	Parameter	Conditions	Min.	Typ.	Max.	Unit
PDR	P_{OUT} detect range	-	0	-	P_{1dB}	dBm
VDET	Detector voltage	$P_{OUT} = 23\text{ dBm}$	-	0.42	-	V
VDET	Detector voltage	$P_{OUT} = 19\text{ dBm}$	-	0.64	-	V
VDET	Detector voltage	$P_{OUT} = \text{NO RF}$	-	0.90	-	V

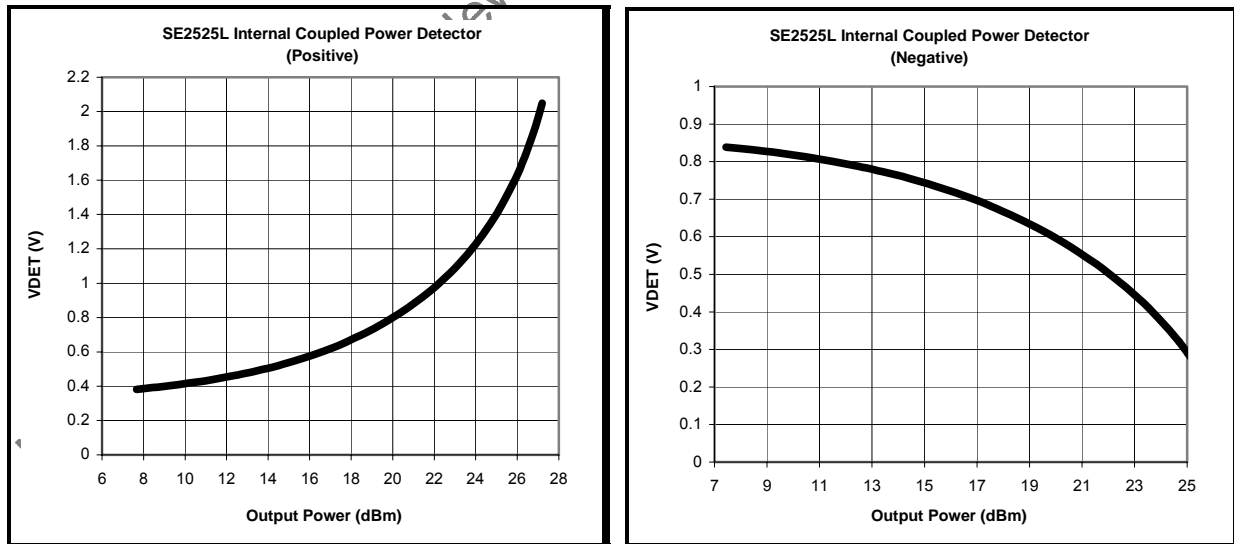

Figure 3: SE2525L Internal Coupled Power Detector Characteristic

External Coupled Power Detector

External Coupled Positive Slope

Conditions: $V_{CC} = V_{EN} = 3.3\text{ V}$, $f = 2.45\text{ GHz}$, V_B connected to V_{REG} , $T_A = 25\text{ }^\circ\text{C}$, $SLOPE_{SEL} = \text{Open Circuit}$, V_{DET} IN/DET_{SEL} = open circuit, as measured on SiGe Semiconductor's SE2525L-EV1 evaluation board, unless otherwise noted.

Symbol	Parameter	Conditions	Min.	Typ.	Max.	Unit
PDET	Input power detect range	-	-10	-	10	dBm
VDET	Detector voltage ⁽¹⁾	$P_{OUT} = 23\text{ dBm}$	-	1.18	-	V
VDET	Detector voltage ⁽¹⁾	$P_{OUT} = 19\text{ dBm}$	-	0.8	-	V
VDET	Detector voltage ⁽¹⁾	$P_{OUT} = \text{NO RF}$	-	0.35	-	V
ZDET	Input Impedance	-	-	275//1.1	-	Ω //pF
PDZ _{OUT}	Output Impedance	-	250	-	700	Ω
PDZ _{LOAD}	DC load impedance	-	10	-	-	k Ω

(1) P_{OUT} measured at the input to the 17dB microstrip coupler on SiGe Semiconductor's SE2525L-EV1 evaluation board

External Coupled Negative Slope

Conditions: $V_{CC} = V_{EN} = 3.3\text{ V}$, $f = 2.45\text{ GHz}$, V_B connected to V_{REG} , $T_A = 25\text{ }^\circ\text{C}$, V_{DET} OUT load = 2.4 k Ω to ground, $SLOPE_{SEL} = \text{GND}$, V_{DET} IN/DET_{SEL} = open circuit, as measured on SiGe Semiconductor's SE2525L-EV1 evaluation board, unless otherwise noted.

Symbol	Parameter	Conditions	Min.	Typ.	Max.	Unit
PDET	Input power detect range	-	-10	-	10	dBm
VDET	Detector voltage ⁽¹⁾	$P_{OUT} = 23\text{ dBm}$	-	0.3	-	V
VDET	Detector voltage ⁽¹⁾	$P_{OUT} = 19\text{ dBm}$	-	0.56	-	V
VDET	Detector voltage ⁽¹⁾	$P_{OUT} = \text{NO RF}$	-	0.90	-	V

(1) P_{OUT} measured at the input to the 17 dB microstrip coupler on SiGe Semiconductor's SE2525L-EV1 evaluation board

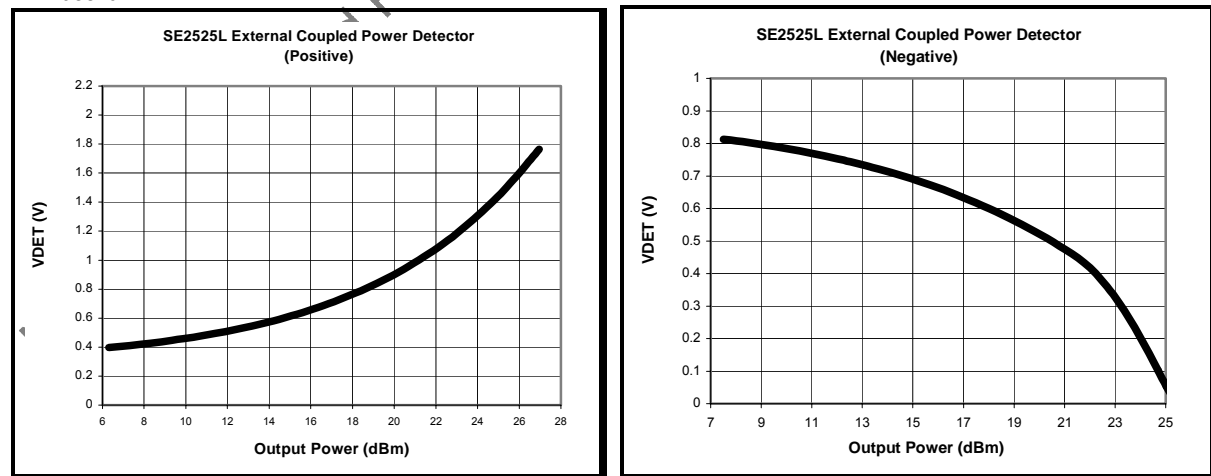

Figure 4: SE2525L External Coupled Power Detector Characteristic

Typical Performance Characteristics

Conditions: $V_{CC} = V_{EN} = 3.3\text{ V}$, $f = 2.45\text{ GHz}$, V_B connected to V_{REG} , $T_A = 25\text{ }^\circ\text{C}$, as measured on SiGe Semiconductor's SE2525L-EV1 evaluation board, unless otherwise noted

General

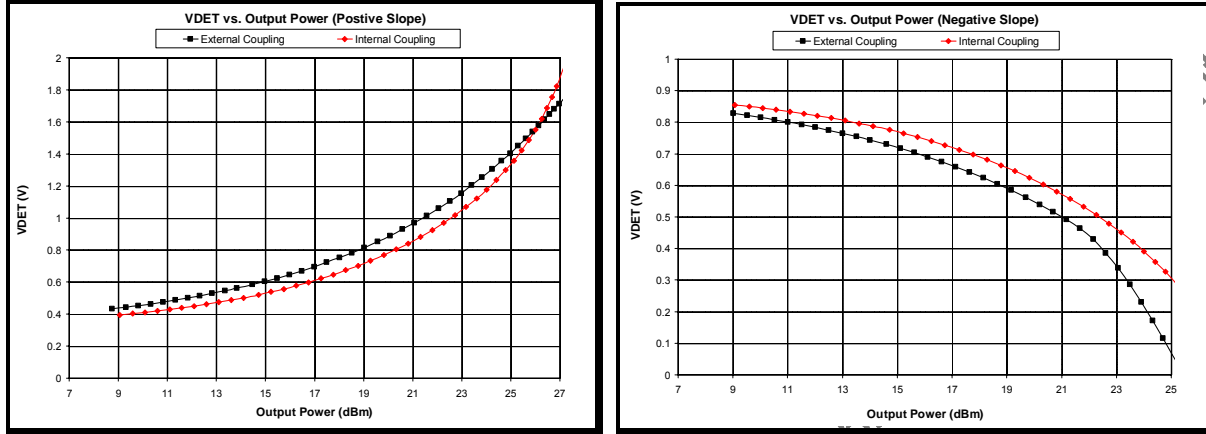

Figure 5: SE2525L Power Detector Response (Positive Slope, Negative Slope)

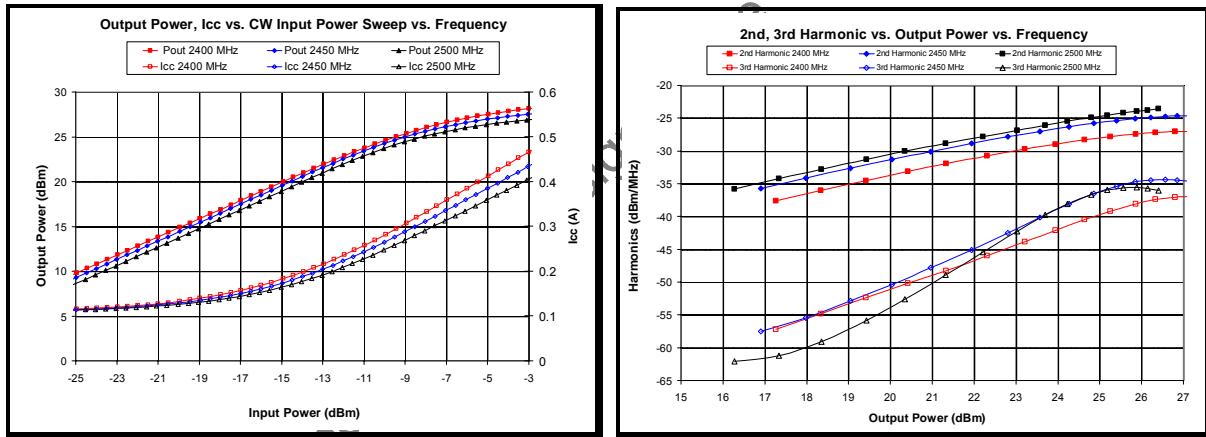

Figure 6: SE2525L CW Sweep and 2nd, 3rd Harmonics

802.11b Performance

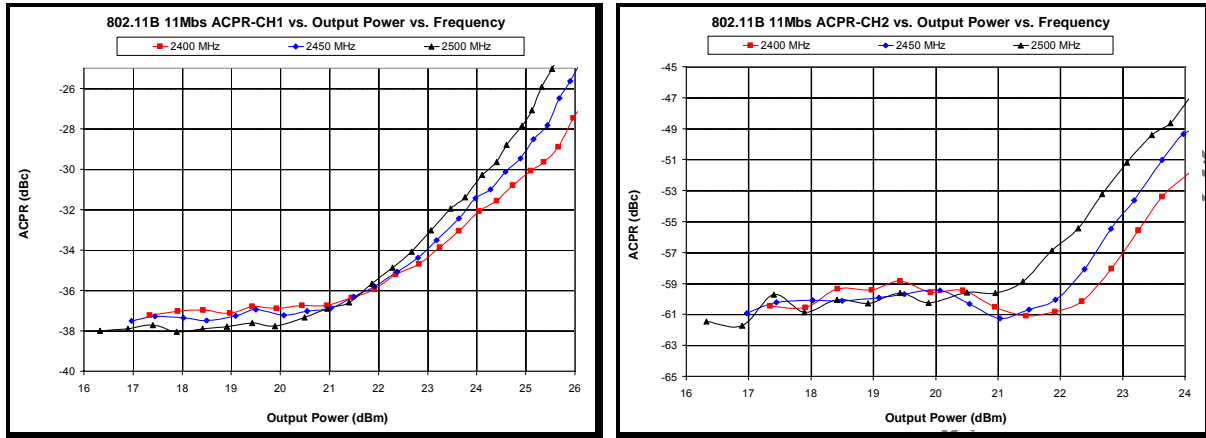

Figure 7: SE2525L Adjacent and Alternate Channel ACPR (Over Frequency)

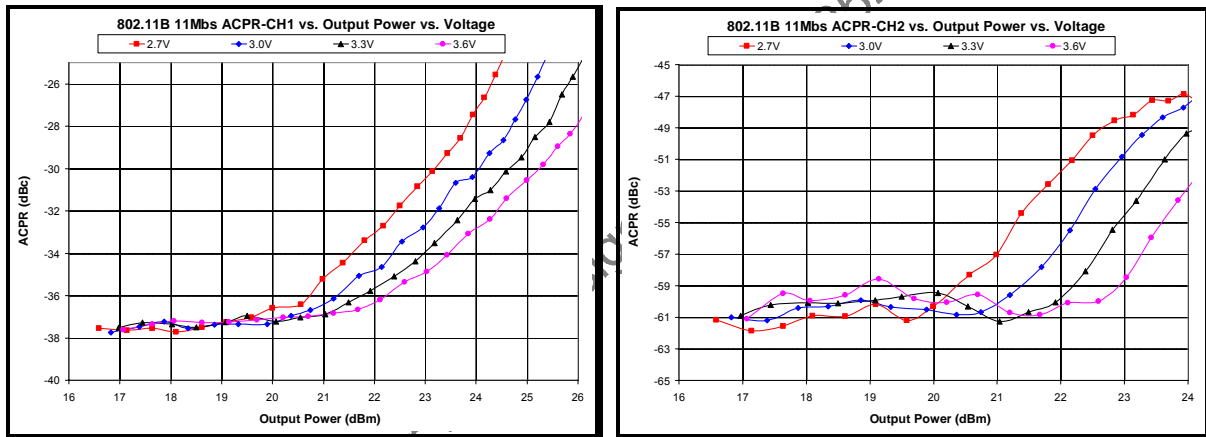

Figure 8: SE2525L Adjacent and Alternate Channel ACPR (Over Voltage)

802.11g Performance

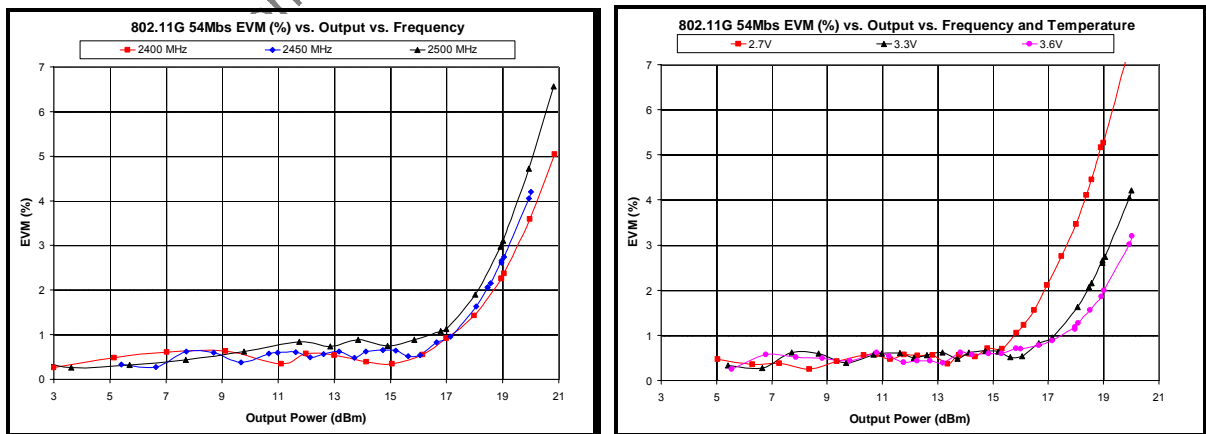
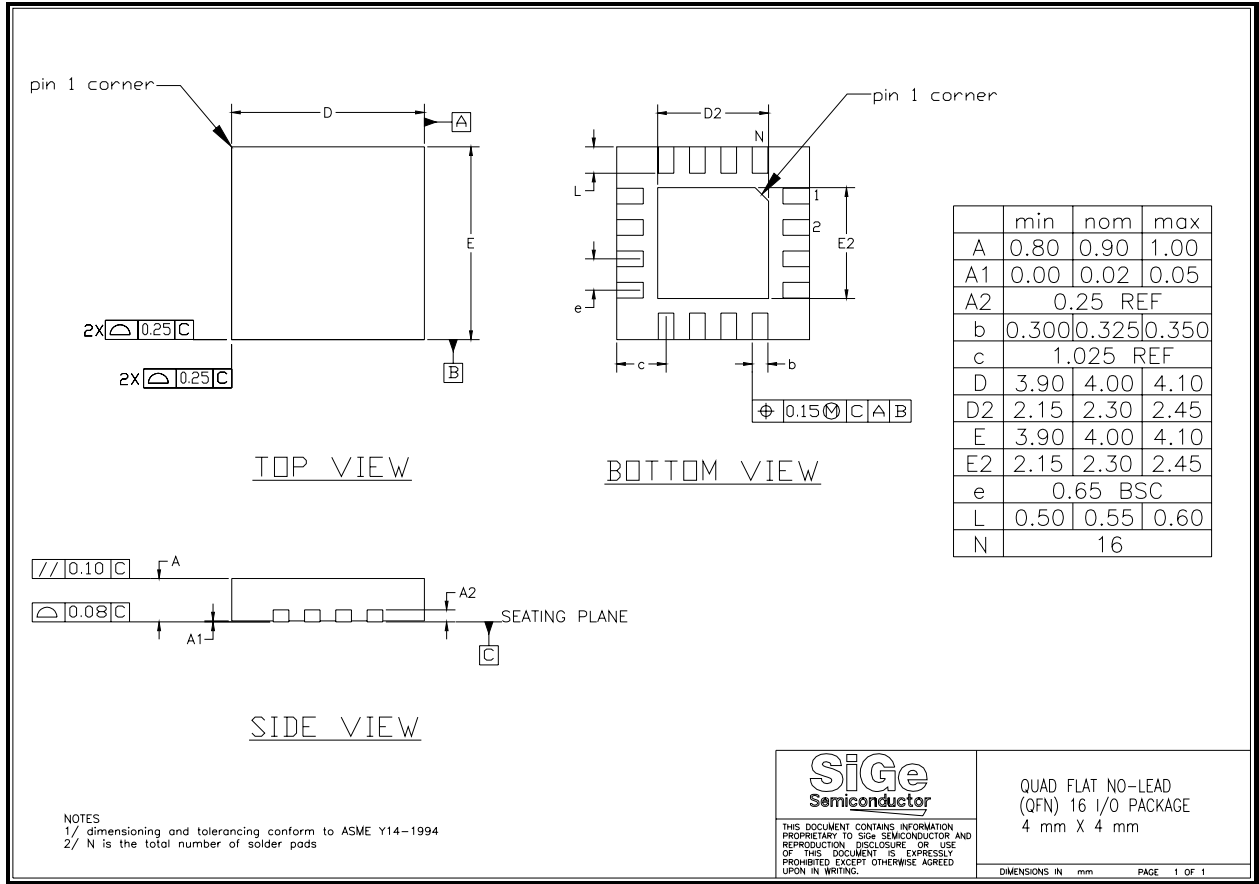

Figure 9: SE2525L 802.11g 54Mbps EVM (Over Frequency, Over Voltage)

Package Information



Not Recommended For New

This page intentionally left blank.

Not Recommended For New Designs. Use SE2528L As Replacement.

<http://www.sige.com>

Email: **sales@sige.com**

Customer Service Locations:

North America:
1050 Morrison Drive, Suite 100
Ottawa ON K2H 8K7 Canada

Phone: +1 613 820 9244
Fax: +1 613 820 4933

Hong Kong
Phone: +852 3428 7222
Fax: +852 3579 5450

San Diego
Phone: +1 858 668 3541 (ext. 226)
Fax: +1 858 668 3546

United Kingdom
Phone: +44 1264 850754
Fax: +44 1264 852601

Product Preview

The datasheet contains information from the product concept specification. SiGe Semiconductor, Inc. reserves the right to change information at any time without notification.

Preliminary Information

The datasheet contains information from the design target specification. SiGe Semiconductor, Inc. reserves the right to change information at any time without notification.

Production testing may not include testing of all parameters.

Information furnished is believed to be accurate and reliable and is provided on an "as is" basis. SiGe Semiconductor, Inc. assumes no responsibility or liability for the direct or indirect consequences of use of such information nor for any infringement of patents or other rights of third parties, which may result from its use. No license or indemnity is granted by implication or otherwise under any patent or other intellectual property rights of SiGe Semiconductor, Inc. or third parties. Specifications mentioned in this publication are subject to change without notice. This publication supersedes and replaces all information previously supplied. SiGe Semiconductor, Inc. products are NOT authorized for use in implantation or life support applications or systems without express written approval from SiGe Semiconductor, Inc.

RangeCharger™, StreamCharger™, and PointCharger™ are trademarks owned by SiGe Semiconductor, Inc.

Copyright 2006 SiGe Semiconductor, Inc.
All Rights Reserved