

DATA SHEET

SE2528L: 2.4 GHz Power Amplifier with Power Detector

Applications

- DSSS 2.4 GHz WLAN (IEEE802.11b)
- OFDM 2.4 GHz WLAN (IEEE802.11g)
- Access Points, PCMCIA, PC cards

Features

- Single 3.3 V Supply Operation
 - 21 dBm, EVM = 3 %, 802.11g, OFDM 54 Mbps
 - 24 dBm, ACPR < -32 dBc, 802.11b
- Dual Supply Operation
 - 23 dBm, EVM = 3 %, 802.11g, OFDM 54 Mbps
 - 25 dBm, ACPR < -32 dBc, 802.11b
- 33 dB Gain
- Pin for pin compatible to the SE2525L
- Selectable Power Detector Slope for use with multiple chipsets (Negative and Positive)
- Integrated power amplifier enable pin (V_{EN})
- Lead Free package, 16 pin 4 mm x 4 mm x 0.9 mm QFN, MSL 1

Ordering Information

Part Number	Package	Remark
SE2528L	16 Pin QFN	Samples
SE2528L-R	16 Pin QFN	Tape and Reel
SE2528L-EK1	Evaluation Kit	Standard

Functional Block Diagram

Product Description

The SE2528L is a 2.4 GHz power amplifier designed for use in the 2.4 GHz ISM band for wireless LAN applications. The device incorporates two selectable power detectors for closed loop monitoring of the output power.

The SE2528L is form, fit and function identical to Skyworks' SE2525L. The SE2528L design can be placed on SE2525L designs to provide higher output power with only a few component changes.

The SE2528L also offers a high power mode by operating at 5 V. This provides an extra 2 dB of improved EVM performance.

The SE2528L includes a digital enable control for device on/off control.

The device is pin for pin compatible to Skyworks' SE2525L, allowing both devices to share the same application board with only a few component changes required. This provides users with both a high and low power solution without changing the layout.

The SE2528L temperature compensated power detector has two selectable power detectors slopes, positive and negative. This allows easy use with multiple chipsets. The detector is also highly immune to mismatch at its output with less than 1.5 dB of variation with a 2:1 mismatch.

DATA SHEET
SE2528L: 2.4 GHz Power Amplifier with Power Detector

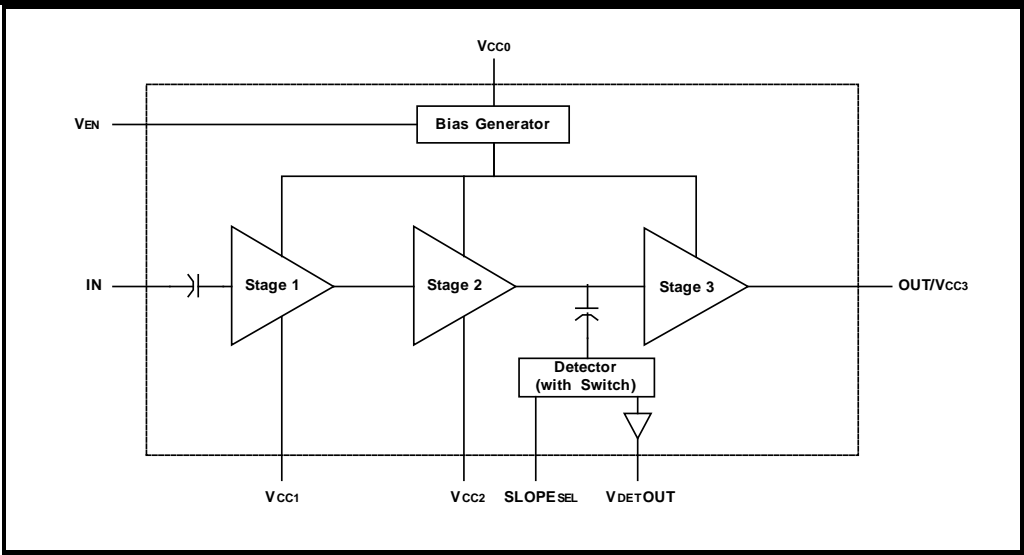

Figure 1: Functional Block Diagram

Pin Out Diagram

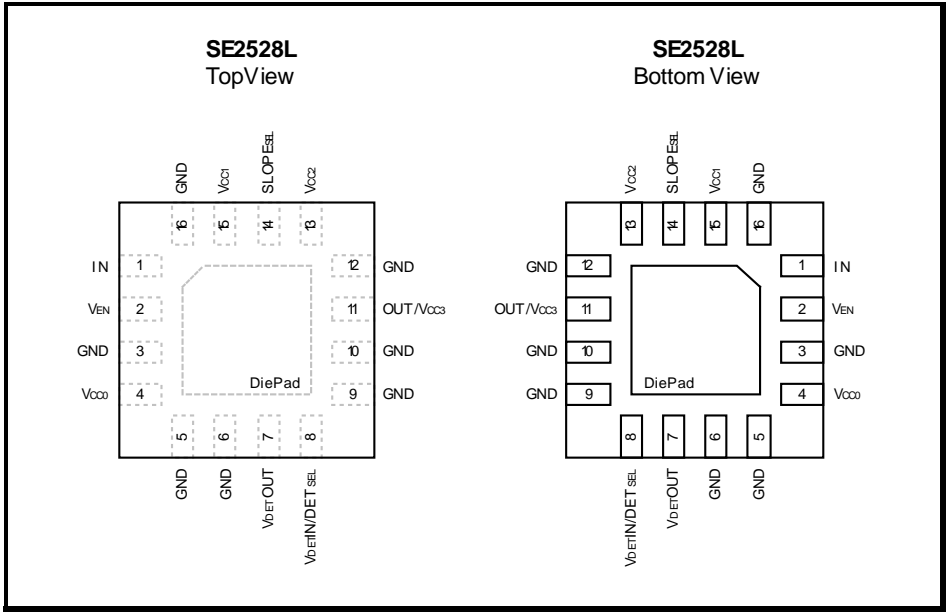

Figure 2: SE2528L Pin-Out Diagram

Pin Out Description

Pin No.	Name	Description
1	IN	Power amplifier RF input
2	VEN	Digital pin used to power up and power down the IC

DATA SHEET
SE2528L: 2.4 GHz Power Amplifier with Power Detector

3	GND	Ground
4	V _{CC0}	Bias/control circuit supply voltage
5	GND	Ground
6	GND	Ground
7	V _{DET} OUT	Analog power detector output
8	V _{DET} IN/DET _{SEL}	Power Detector Input (Not used, must be grounded)
9 -10	GND	Ground
11	OUT/ V _{CC3}	Power Amplifier RF output and Stage 3 collector supply voltage
12	GND	Ground
13	V _{CC2}	Stage 2 collector supply
14	SLOPE _{SEL}	Slope Select (N/C = Positive, GND = Negative)
15	V _{CC1}	Stage 1 collector supply
16	GND	Ground
Die Pad	GND	Exposed die pad; electrical and thermal ground

Absolute Maximum Ratings

These are stress ratings only. Exposure to stresses beyond these maximum ratings for a long period of time may cause permanent damage to, or affect the reliability of the device. Avoid operating the device outside the recommended operating conditions defined below. This device is ESD sensitive. Handling and assembly of this device should be at ESD protected workstations.

Symbol	Definition	Min.	Max.	Unit
V _{CC}	Supply Voltage on pins V _{CC0} , V _{CC1} , and V _{CC2}	-0.3	4	V
V _{CC3}	Supply Voltage on pins V _{CC3} (Note: SE2528L application circuit must be followed for operation above 3.6 V)	-0.3	5.5	V
V _{EN}	Power Amplifier Enable	-0.3	V _{CC0} + 0.3	V
IN	RF Input Power	-	2	dBm
T _{STG}	Storage Temperature Range	-40	150	°C
T _j	Maximum Junction Temperature	-	150	°C
ESD _{HBM}	JEDEC JESD22-A114	-	100	V

Recommended Operating Conditions

Symbol	Parameter	Min.	Max.	Unit
V _{CC}	Supply Voltage on pins V _{CC0} , V _{CC1} , V _{CC2}	2.9	3.6	V

DATA SHEET

SE2528L: 2.4 GHz Power Amplifier with Power Detector

Symbol	Parameter	Min.	Max.	Unit
V _{CC3}	Supply Voltage on pins V _{CC3} (Note: SE2528L application circuit must be followed for operation above 3.6 V)	2.9	5.5	V
T _A	Ambient Temperature	-40	85	°C

DC Electrical Characteristics

Conditions: V_{CC} = V_{CC3} = V_{EN} = 3.3 V, T_A = 25 °C, as measured on Skyworks Solutions' SE2528L-EV1 evaluation board, unless otherwise noted.

Symbol	Parameter	Conditions	Min.	Typ.	Max.	Unit
I _{CC-802.11b}	Supply Current (Sum of V _{CC0} , V _{CC1} , V _{CC2} , V _{CC3})	P _{OUT} = 24 dBm, 11 Mbps CCK signal, BT = 0.45, V _{CC} = V _{CC3} = 3.3 V	-	300	-	mA
		P _{OUT} = 25 dBm, 11 Mbps CCK signal, BT = 0.45, V _{CC} = 3.3 V, V _{CC3} = 5.0 V	-	375	475	mA
I _{CC-802.11g}	Supply Current (Sum of V _{CC0} , V _{CC1} , V _{CC2} , V _{CC3})	P _{OUT} = 21 dBm, 54 Mbps OFDM signal, 64 QAM, V _{CC} = V _{CC3} = 3.3 V	-	230	-	mA
		P _{OUT} = 23 dBm, 54 Mbps OFDM signal, 64 QAM, V _{CC} = 3.3 V, V _{CC3} = 5.0 V	-	290	340	mA
I _{OFF}	Supply Current	V _{EN} = 0 V, No RF	-	3	10	μA
V _{ENH}	Logic High Voltage	-	1.3	-	V _{CC}	V
V _{ENL}	Logic Low Voltage	-	0	-	0.5	V

AC Electrical Characteristics

802.11b/g AC Electrical Characteristics (3.3 V)

Conditions: V_{CC} = V_{CC3} = V_{EN} = 3.3 V, f = 2.45 GHz, T_A = 25 °C, as measured on Skyworks Solutions' SE2528L-EV1 evaluation board, unless otherwise noted

Symbol	Parameter	Conditions	Min.	Typ.	Max.	Unit
f _{L-U}	Frequency Range	-	2400	-	2500	MHz
P _{1dB}	Output 1dB compression point	No modulation	25	26.5	-	dBm
S ₂₁	Small Signal Gain	P _{IN} = -25 dBm	30	33	36	dB
ΔS ₂₁	Gain Variation over band	P _{IN} = -25 dBm, f _{IN} = 2400 to 2500 MHz	-	1	-	dB
ACPR	Adjacent Channel Power Ratio ±11 MHz offsets from carrier ±22 MHz offsets from carrier	P _{OUT} = 24 dBm, 11 Mbps CCK signal, BT = 0.45	- -	-37 -60	-30 -50	dBc
2f	Harmonic	P _{OUT} = 24 dBm, CW	-	-40	-	dBm/MHz
3f			-	-40	-	dBm/MHz
EVM	Error Vector Magnitude	P _{OUT} = 21 dBm, 54	-	3.0	-	%

DATA SHEET
SE2528L: 2.4 GHz Power Amplifier with Power Detector

Symbol	Parameter	Conditions	Min.	Typ.	Max.	Unit
		Mbps OFDM signal, 64 QAM				
t_r, t_f	Rise and Fall Time	-	-	0.5	-	μ Sec
STAB	Stability	$P_{IN} \leq 2$ dBm, $P_{OUT} = 24$ dBm, 54 Mbps OFDM signal, 64 QAM VSWR = 6:1 All Phases	All non-harmonically related outputs less than -50 dBc/100 kHz			
VSWR	Tolerance to output load mismatching	$P_{IN} \leq 2$ dBm, $P_{OUT} = 24$ dBm, 54 Mbps OFDM signal, 64 QAM VSWR = 10:1 All Phases	No damage			

802.11b/g AC Electrical Characteristics (5 V)

Conditions: $V_{CC} = V_{EN} = 3.3$ V, $V_{CC3} = 5$ V, $f = 2.45$ GHz, $T_A = 25$ °C, as measured on Skyworks Solutions' SE2528L-EV1 evaluation board, unless otherwise noted.

Symbol	Parameter	Conditions	Min.	Typ.	Max.	Unit
f_{L-U}	Frequency Range	-	2400	-	2500	MHz
P_{1dB}	Output 1dB compression point	No modulation	27	28.5	-	dBm
S_{21}	Small Signal Gain	$P_{IN} = -25$ dBm	30	34	36.5	dB
ΔS_{21}	Gain Variation over band	$P_{IN} = -25$ dBm, $f_{IN} = 2400$ to 2500 MHz	-	1	-	dB
ACPR	Adjacent Channel Power Ratio ± 11 MHz offsets from carrier ± 22 MHz offsets from carrier	$P_{OUT} = 25$ dBm, 11 Mbps CCK signal, BT = 0.45	-	-37	-30	dBc
2f	Harmonic	$P_{OUT} = 25$ dBm, CW	-	-45	-	dBm/MHz
3f			-	-35	-	dBm/MHz
EVM	Error Vector Magnitude	$P_{OUT} = 23$ dBm, 54 Mbps OFDM signal, 64 QAM	-	3.0	-	%
t_r, t_f	Rise and Fall Time	-	-	0.5	-	μ Sec
STAB	Stability	$P_{IN} \leq 2$ dBm, $P_{OUT} = 25$ dBm, 54 Mbps OFDM signal, 64 QAM VSWR = 6:1 All Phases	All non-harmonically related outputs less than -50 dBc/100 kHz			
VSWR	Tolerance to output load mismatching	$P_{IN} \leq 2$ dBm, $P_{OUT} = 25$ dBm, 54 Mbps OFDM signal, 64 QAM VSWR = 10:1 All	No damage			

DATA SHEET

SE2528L: 2.4 GHz Power Amplifier with Power Detector

Symbol	Parameter	Conditions	Min.	Typ.	Max.	Unit
		Phases				

Detector Selection Logic

Conditions: $V_{CC} = V_{EN} = 3.3\text{ V}$, $V_{CC3} = 3.3\text{ V OR } 5\text{ V}$, $T_A = 25\text{ }^\circ\text{C}$, as measured on Skyworks Solutions' SE2528L-EV1 evaluation board, unless otherwise noted

SLOPE _{SEL}	Detector Slope	Detector Signal Source
Open Circuit	Positive	Internal
Ground	Negative	Internal

Power Detector

Positive Slope

Conditions: " $V_{CC} = V_{CC3} = V_{EN} = 3.3\text{ V}$ " OR " $V_{CC} = V_{EN} = 3.3\text{ V}$, $V_{CC3} = 5\text{ V}$ ", $f = 2.45\text{ GHz}$, SLOPE_{SEL} = Open Circuit, $V_{DET\ IN}/DET_{SEL} = GND$, $T_A = 25\text{ }^\circ\text{C}$, as measured on Skyworks Solutions' SE2528L-EV1 evaluation board, unless otherwise noted

Symbol	Parameter	Conditions	Min.	Typ.	Max.	Unit
PDR	P _{OUT} detect range	-	0	-	P _{1dB}	dBm
VDET	Detector voltage	P _{OUT} = 23 dBm	0.92	1.04	1.16	V
VDET	Detector voltage	P _{OUT} = 21 dBm	0.75	0.88	0.99	V
VDET	Detector voltage	P _{OUT} = NO RF	0.26	0.32	0.36	V
PDZ _{OUT}	Output Impedance	-	250	-	700	Ω
PDZ _{LOAD}	DC load impedance	-	10	-	-	k Ω

Negative Slope

Conditions: " $V_{CC} = V_{CC3} = V_{EN} = 3.3\text{ V}$ " OR " $V_{CC} = V_{EN} = 3.3\text{ V}$, $V_{CC3} = 5\text{ V}$ ", $f = 2.45\text{ GHz}$, $V_{DET\ OUT}$ load = 2.4 kohm, SLOPE_{SEL} = $V_{DET\ IN}/DET_{SEL} = GND$, $T_A = 25\text{ }^\circ\text{C}$, as measured on Skyworks Solutions' SE2528L-EV1 evaluation board, unless otherwise noted

Symbol	Parameter	Conditions	Min.	Typ.	Max.	Unit
PDR	P _{OUT} detect range	-	0	-	P _{1dB}	dBm
VDET	Detector voltage	P _{OUT} = 23 dBm	0.19	0.30	0.45	V
VDET	Detector voltage	P _{OUT} = 21 dBm	0.31	0.42	0.54	V
VDET	Detector voltage	P _{OUT} = NO RF	0.9	0.95	1.02	V
PDZ _{OUT}	Output Impedance	-	2.2	2.4	3.0	k Ω

DATA SHEET
SE2528L: 2.4 GHz Power Amplifier with Power Detector

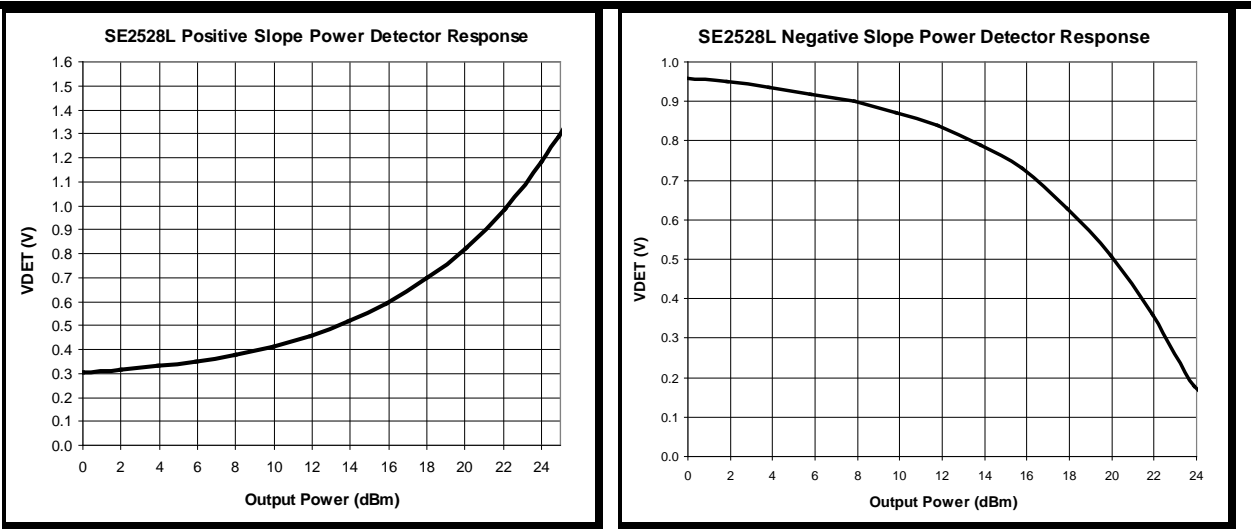

Figure 3: SE2528L Power Detector Characteristic

DATA SHEET
SE2528L: 2.4 GHz Power Amplifier with Power Detector

Typical 3.3V Performance Characteristics

Conditions: $V_{CC} = V_{CC3} = V_{EN} = 3.3\text{ V}$, $f = 2.45\text{ GHz}$, $T_A = 25\text{ }^\circ\text{C}$, as measured on Skyworks Solutions' SE2528L-EV1 evaluation board, unless otherwise noted

802.11g Performance

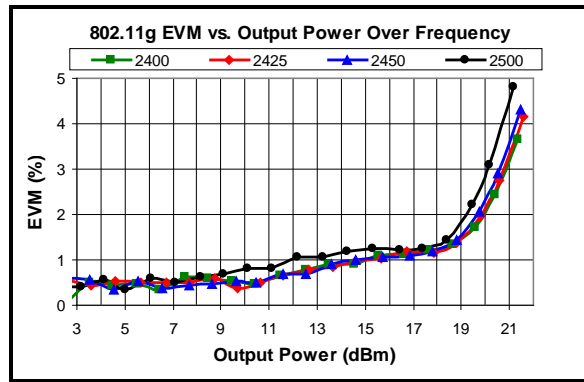

Figure 4: SE2528L 802.11g 54 Mbps EVM (Over Frequency)

802.11b Performance

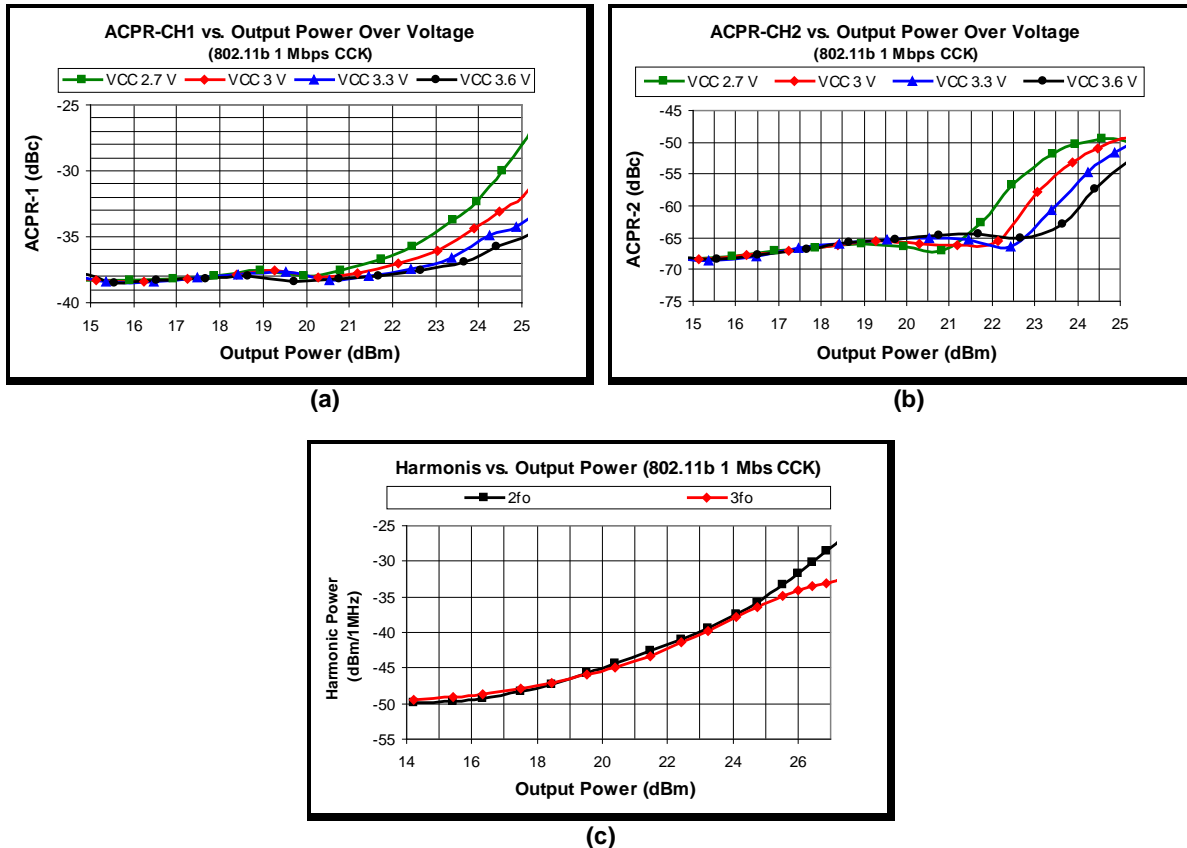

Figure 5: Typical 802.11b Performance (a) ACPR-CH1 vs. Output Power Over Voltage, (b) ACPR-2 vs. Output Power Over Voltage and (c) 2nd and 3rd Harmonics vs. Output Power

DATA SHEET
SE2528L: 2.4 GHz Power Amplifier with Power Detector

Typical 3.3V Performance Characteristics (Continued)

General (CW)

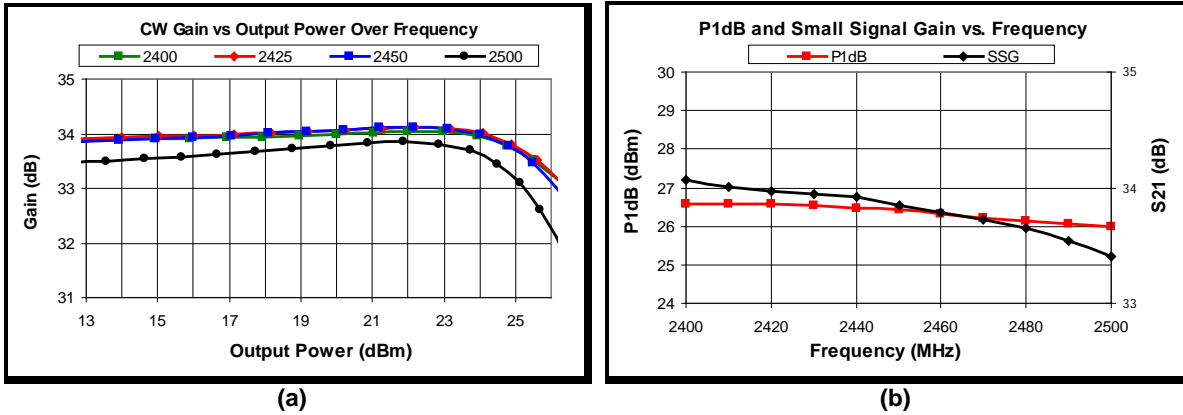

Figure 6: Typical CW Performance (a) Gain vs. Output Power over Frequency and (b) P1db and Small Signal Gain vs. Frequency

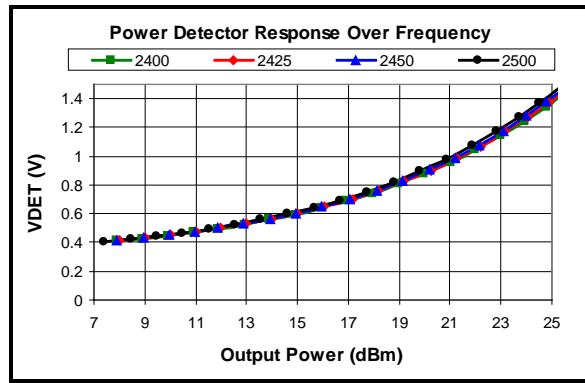

Figure 7: Power Detector Response Over Frequency

DATA SHEET
SE2528L: 2.4 GHz Power Amplifier with Power Detector

Typical 5 V Performance Characteristics

Conditions: $V_{CC} = V_{EN} = 3.3\text{ V}$, $V_{CC3} = 5\text{ V}$, $f = 2.45\text{ GHz}$, $T_A = 25\text{ }^\circ\text{C}$, as measured on Skyworks Solutions' SE2528L-EV1 evaluation board, unless otherwise noted

802.11g Performance

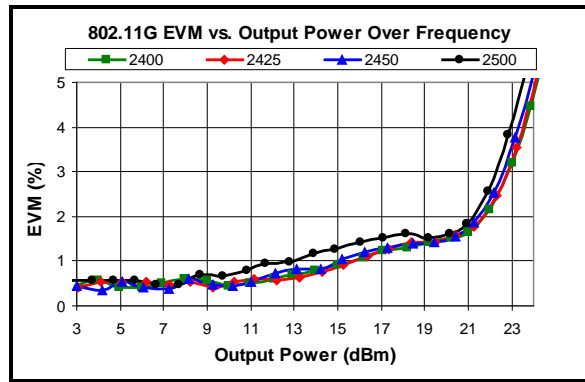

Figure 8: SE2528L 802.11g 54 Mbps EVM

General (CW)

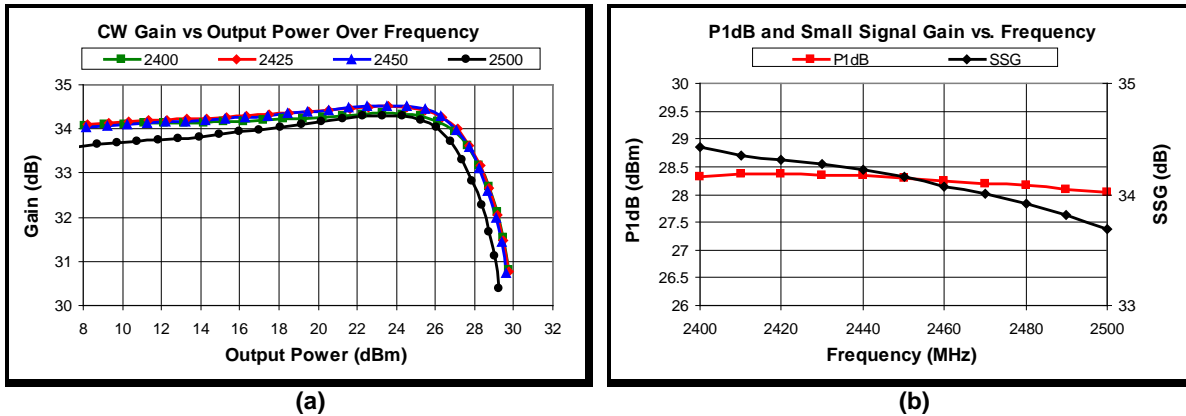

Figure 9: CW Typical Performance (a) Gain vs. Output Power over Frequency and (b) P1db and Small Signal Gain vs. Frequency

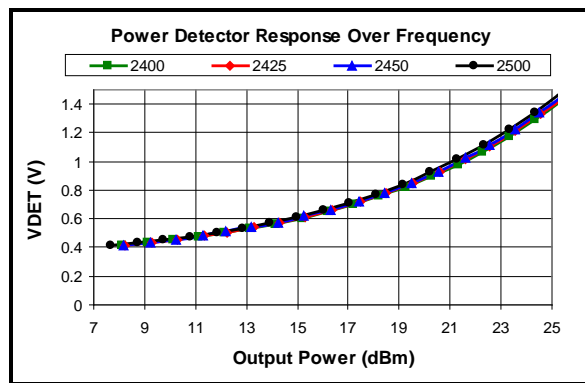

Figure 10: Power Detector Response (Over Frequency)

DATA SHEET
SE2528L: 2.4 GHz Power Amplifier with Power Detector

Application Circuit

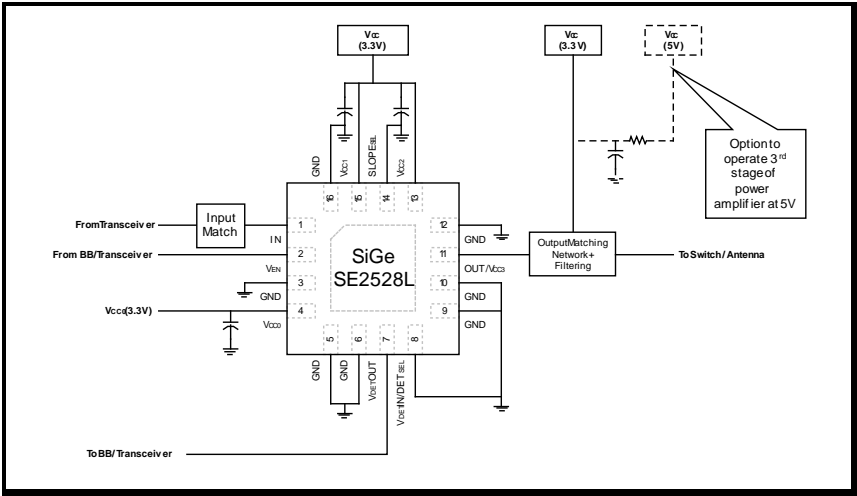

Figure 11: SE2528L Application Circuit

DATA SHEET
SE2528L: 2.4 GHz Power Amplifier with Power Detector

Package Handling Information

Because of its sensitivity to moisture absorption, instructions on the shipping container label must be followed regarding exposure to moisture after the container seal is broken, otherwise, problems related to moisture absorption may occur when the part is subjected to high temperature during solder assembly. The SE2528L is capable of withstanding a Pb free solder reflow. Care must be taken when attaching this product, whether it is done manually or in a production solder reflow environment. If the part is manually attached, precaution should be taken to insure that the device is not subjected to temperatures above its rated peak temperature for an extended period of time. For details on both attachment techniques, precautions, and handling procedures recommended, please refer to:

- “Quad Flat No-Lead Module Solder Reflow & Rework Information”, *Document Number QAD-00045*
- “Handling, Packing, Shipping and Use of Moisture Sensitive QFN”, *Document Number QAD-00044*
- “ESD Control Policy”, *Document Number SQ03-0062*



Caution! Class 0 ESD sensitive device

Branding Information

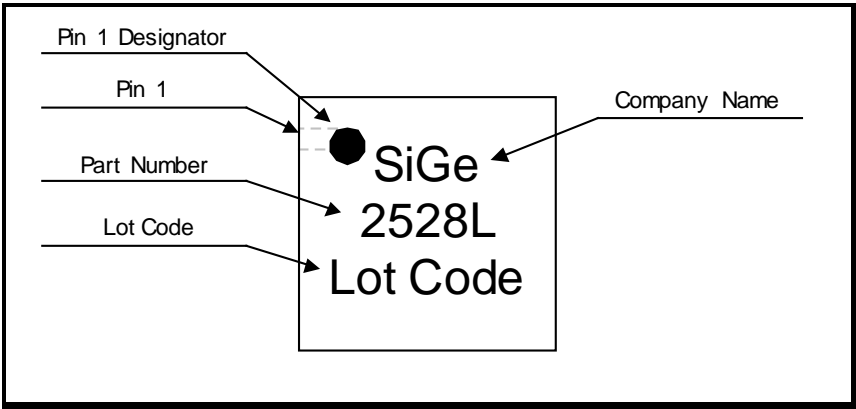

Figure 12: SE2528L Branding Information

Tape and Reel Information

Parameter	Value
Devices Per Reel	3000
Reel Diameter	13 inches
Tape Width	12 millimeters

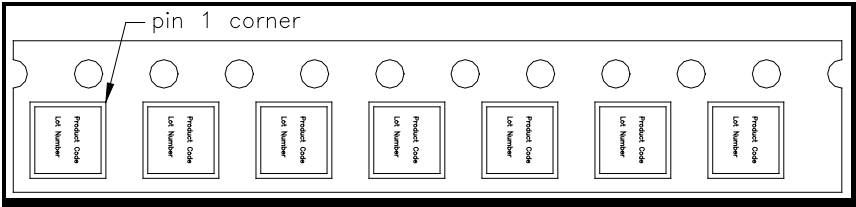

Figure 13: SE2528L-R Tape and Reel Information

DATA SHEET
SE2528L: 2.4 GHz Power Amplifier with Power Detector

Package Information

This package is lead free.

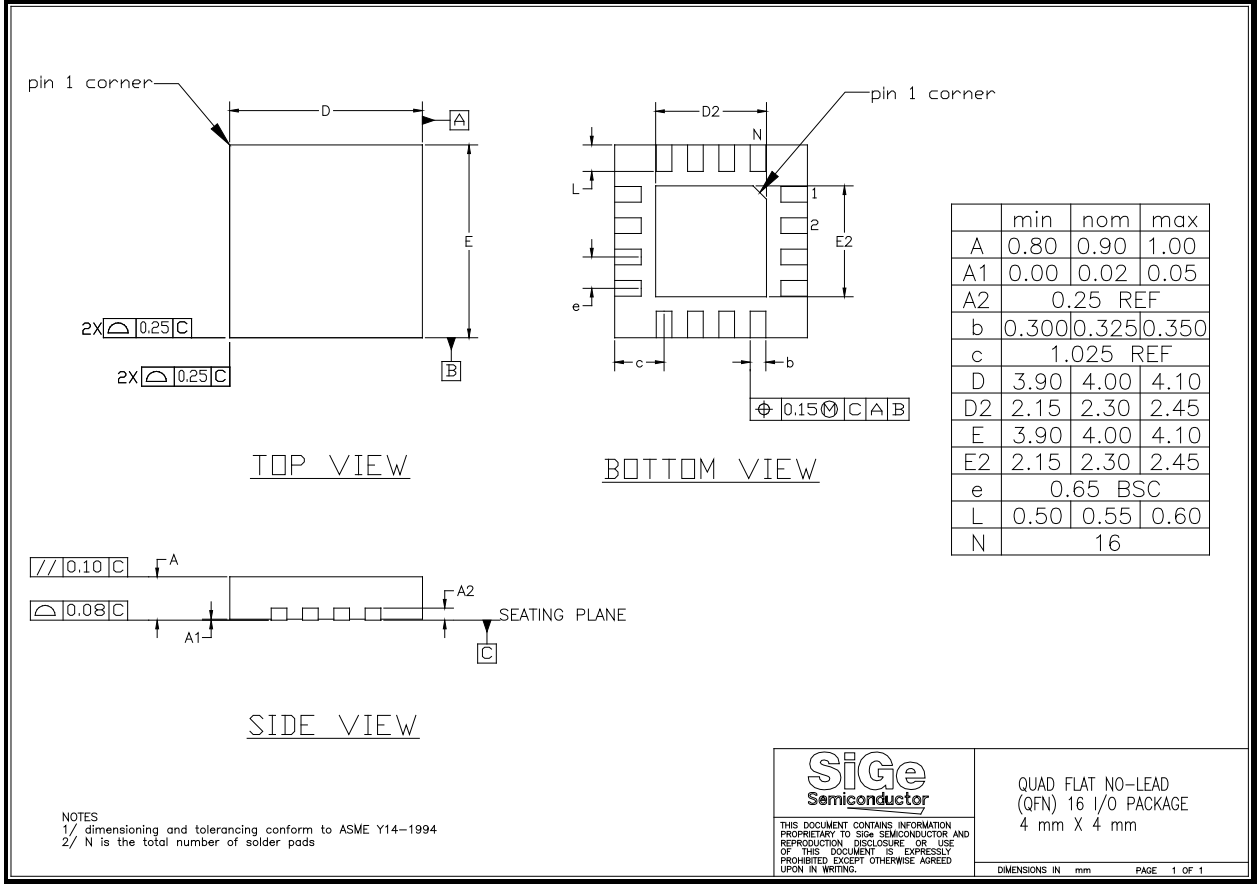

Figure 14: SE2528L Package Drawing

DATA SHEET
SE2528L: 2.4 GHz Power Amplifier with Power Detector

Document Change History

Revision	Date	Notes
1.1	Apr 13, 2006	Created
1.2	Sep 10, 2008	Updated to remove blocking capacitor requirement on RF Input pin
1.3	May 26, 2009	Amended back page
1.4	Feb 9, 2011	Extended operating temperature to Industrial grade.
1.5	Mar 28, 2012	Updated with Skyworks logo and disclaimer statement

Copyright © 2012 Skyworks Solutions, Inc. All Rights Reserved.

Information in this document is provided in connection with Skyworks Solutions, Inc. ("Skyworks") products or services. These materials, including the information contained herein, are provided by Skyworks as a service to its customers and may be used for informational purposes only by the customer. Skyworks assumes no responsibility for errors or omissions in these materials or the information contained herein. Skyworks may change its documentation, products, services, specifications or product descriptions at any time, without notice. Skyworks makes no commitment to update the materials or information and shall have no responsibility whatsoever for conflicts, incompatibilities, or other difficulties arising from any future changes.

No license, whether express, implied, by estoppel or otherwise, is granted to any intellectual property rights by this document. Skyworks assumes no liability for any materials, products or information provided hereunder, including the sale, distribution, reproduction or use of Skyworks products, information or materials, except as may be provided in Skyworks Terms and Conditions of Sale.

THE MATERIALS, PRODUCTS AND INFORMATION ARE PROVIDED "AS IS" WITHOUT WARRANTY OF ANY KIND, WHETHER EXPRESS, IMPLIED, STATUTORY, OR OTHERWISE, INCLUDING FITNESS FOR A PARTICULAR PURPOSE OR USE, MERCHANTABILITY, PERFORMANCE, QUALITY OR NON-INFRINGEMENT OF ANY INTELLECTUAL PROPERTY RIGHT; ALL SUCH WARRANTIES ARE HEREBY EXPRESSLY DISCLAIMED. SKYWORKS DOES NOT WARRANT THE ACCURACY OR COMPLETENESS OF THE INFORMATION, TEXT, GRAPHICS OR OTHER ITEMS CONTAINED WITHIN THESE MATERIALS. SKYWORKS SHALL NOT BE LIABLE FOR ANY DAMAGES, INCLUDING BUT NOT LIMITED TO ANY SPECIAL, INDIRECT, INCIDENTAL, STATUTORY, OR CONSEQUENTIAL DAMAGES, INCLUDING WITHOUT LIMITATION, LOST REVENUES OR LOST PROFITS THAT MAY RESULT FROM THE USE OF THE MATERIALS OR INFORMATION, WHETHER OR NOT THE RECIPIENT OF MATERIALS HAS BEEN ADVISED OF THE POSSIBILITY OF SUCH DAMAGE.

Skyworks products are not intended for use in medical, lifesaving or life-sustaining applications, or other equipment in which the failure of the Skyworks products could lead to personal injury, death, physical or environmental damage. Skyworks customers using or selling Skyworks products for use in such applications do so at their own risk and agree to fully indemnify Skyworks for any damages resulting from such improper use or sale.

Customers are responsible for their products and applications using Skyworks products, which may deviate from published specifications as a result of design defects, errors, or operation of products outside of published parameters or design specifications. Customers should include design and operating safeguards to minimize these and other risks. Skyworks assumes no liability for applications assistance, customer product design, or damage to any equipment resulting from the use of Skyworks products outside of stated published specifications or parameters.

Skyworks, the Skyworks symbol, and "Breakthrough Simplicity" are trademarks or registered trademarks of Skyworks Solutions, Inc., in the United States and other countries. Third-party brands and names are for identification purposes only, and are the property of their respective owners. Additional information, including relevant terms and conditions, posted at www.skyworksinc.com, are incorporated by reference.