

Model SF1005

• Specifications



	Unit	Min.	Typical	Max
Center Frequency, Fc	MHz		140	
Insertion Loss	dB		19.5	24.0
1 dB Bandwidth	MHz	7.5	7.8	
3 dB Bandwidth	MHz	7.75	8.2	
35 dB Bandwidth	MHz		9.6	9.9
Group Delay Ripple	P-P nsec		120	200
Passband Ripple	P-P dB		0.85	1.25
Ultimate Rejection	dBc	35	43.0	
Operating Temperature Range	°C	0	25	70
Absolute Group Delay	usec	1.42	1.52	1.62
Package	mm ³	13.3 x 6.5 x 2.0		

• Matching Circuit

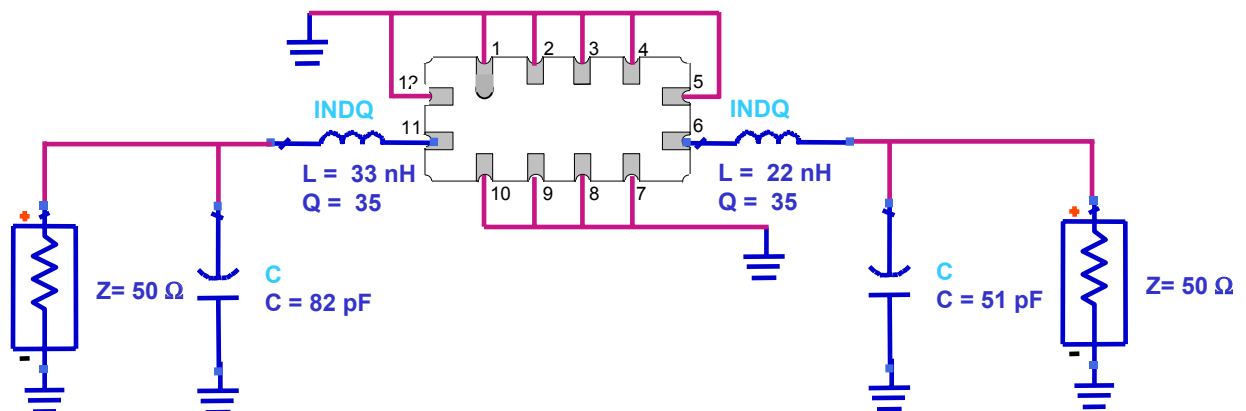

MtronPTI reserves the right to make changes to the product(s) and service(s) described herein without notice. No liability is assumed as a result of their use or application.

Please see www.mtronpti.com for our complete offering and detailed datasheets. Contact us for your application specific requirements: MtronPTI 1-800-762-8800.