

SF11~SF18

SUPERFAST RECOVERY RECTIFIERS

Reverse Voltage – 50 to 600 Volts

Forward Current – 1.0 Ampere

DO-41

Features

- Plastic package has Underwriters Laboratory Flammability Classification 94V-0.
- High surge capability
- Low forward voltage, high current capability
- Hermetically sealed
- Super-fast recovery times
- Low leakage

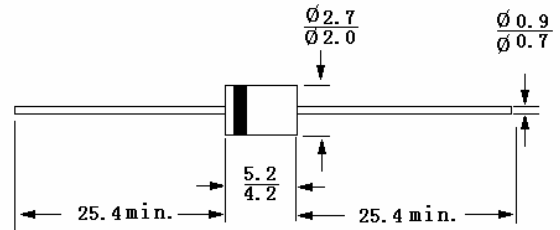

Dimensions in mm

Mechanical Data

- **Case:** DO-41 molded plastic
- **Terminals:** Axial Leads, solderable per MIL-STD-202, method 208 guaranteed
- **Polarity:** Colored band denotes cathode end
- **Mounting position:** Any

Absolute Maximum Ratings and Characteristics

Rating at 25°C ambient temperature unless otherwise specified. Single phase, half wave, 60Hz, resistive or inductive load, for capacitive load, derate current by 20%.

	Symbols	SF11	SF12	SF13	SF14	SF15	SF16	SF18	Unit
Maximum Recurrent Peak Reverse Voltage	V_{RRM}	50	100	150	200	300	400	600	V
Maximum RMS Voltage	V_{RMS}	35	70	105	140	210	280	420	V
Maximum DC Blocking Voltage	V_{DC}	50	100	150	200	300	400	600	V
Maximum Average Forward Rectified Current 0.375" (9.5mm) Lead Length at $T_A = 55^\circ\text{C}$	$I_{(AV)}$	1.0							A
Peak Forward Surge Current 8.3ms single half sine-wave superimposed on rated load (JEDEC method)	I_{FSM}	30							A
Maximum Forward Voltage at 1.0A	V_F	0.95			1.25		1.7		V
Maximum Reverse Current at Rated DC Blocking Voltage $T_a = 25^\circ\text{C}$ $T_a = 100^\circ\text{C}$	I_R	5.0 500							μA
Maximum Reverse Recovery Time (note1)	T_{RR}	35						50	nS
Typical Junction Capacitance(note2)	C_J	50				25			pF
Typical Thermal Resistance(note3)	$R_{\theta JA}$	50							$^\circ\text{C/W}$
Operating Junction Temperature	T_J	-55 to +150							$^\circ\text{C}$
Storage Temperature Range	T_S	-55 to +150							$^\circ\text{C}$

Notes: 1.Reverse recovery test conditions: $I_F = 0.5\text{A}$, $I_R = 1.0\text{A}$, $I_{RR} = 0.25\text{A}$

2.Measured at 1.0MHz and applied reverse voltage of 4.0V

3.Thermal resistance from junction to ambient 0.375" (9.5mm) lead length P.C.B mounted.

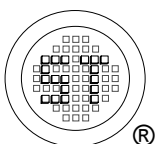

SEMTECH ELECTRONICS LTD.

(Subsidiary of Sino-Tech International Holdings Limited, a company
listed on the Hong Kong Stock Exchange, Stock Code: 724)



ISO/TS 16949 : 2002
Certificate No. 05103



ISO 14001:2004
Certificate No. 7116



ISO 9001:2000
Certificate No. 0506098

Dated : 13/05/2005 H

SF11~SF18

REVERSE RECOVERY TIME CHARACTERISTIC AND TEST CIRCUIT DIAGRAM

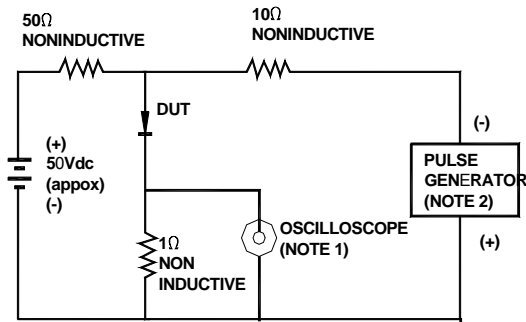

NOTES: 1. Rise Time=7ns max. Input Impedance=1 megohm 22 pf
 2. Rise Time=10ns max. Source Impedance=50 ohms

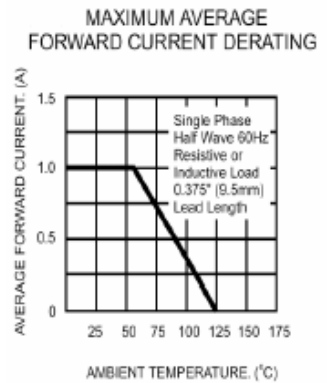
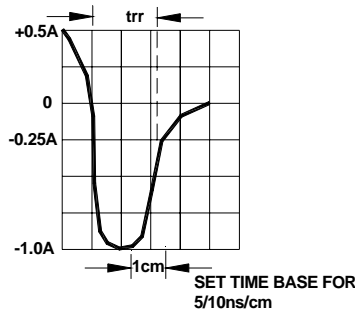

Typical reverse characteristics

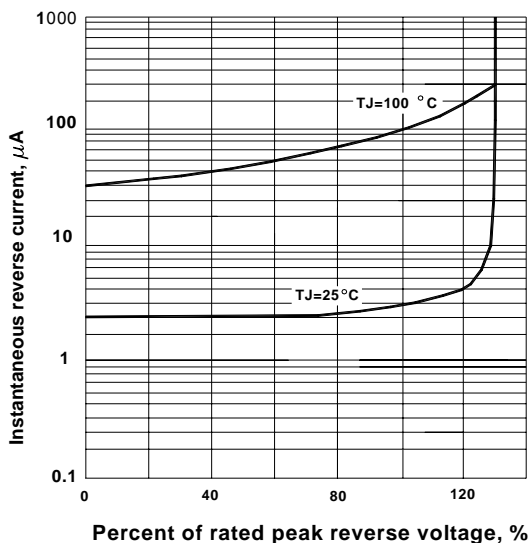

Typical forward characteristics

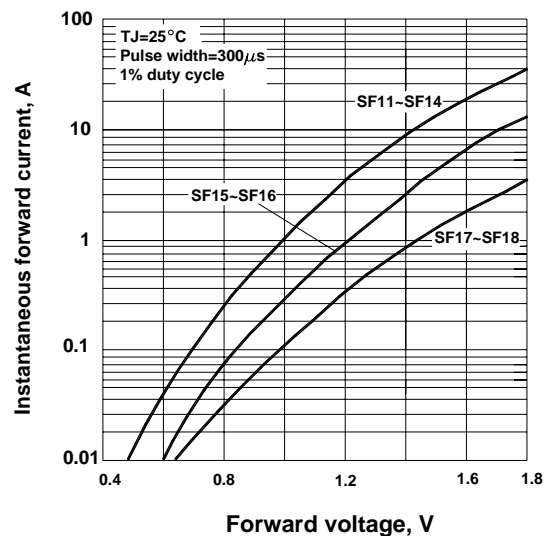

Maximum non-repetitive forward surge current

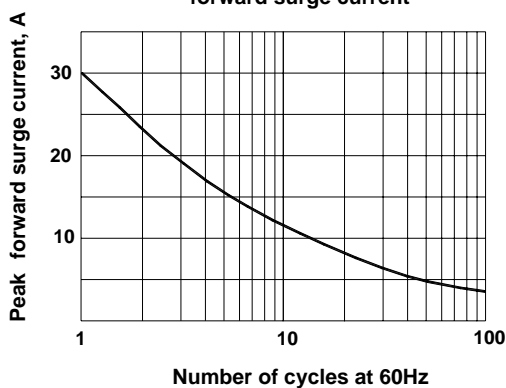

Typical junction capacitance

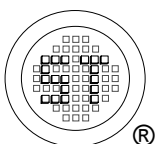
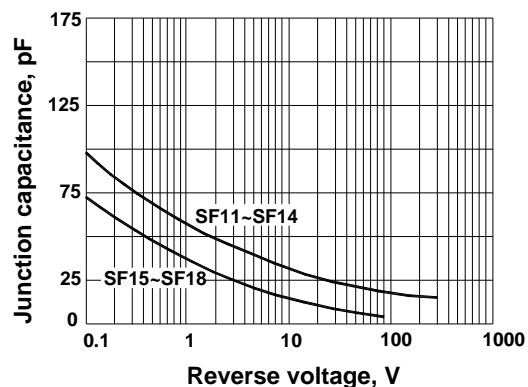

SEMTECH ELECTRONICS LTD.

(Subsidiary of Sino-Tech International Holdings Limited, a company listed on the Hong Kong Stock Exchange, Stock Code: 724)



ISO/TS 16949 : 2002 Certificate No. 05103



ISO 14001:2004 Certificate No. 71116



ISO 9001:2000 Certificate No. 0506098

Dated : 13/05/2005 H