

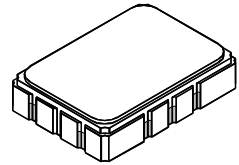

SF1142B

**315.00 MHz
SAW Filter**

- **Designed for SDARS IF Receiver**
- **Low Insertion Loss**
- **5.0 X 7.0 mm Surface-Mount Case**
- **Differential Input and Output**
- **Complies with Directive 2002/95/EC (RoHS)**



SMP-03

Absolute Maximum Ratings

Rating	Value	Units
Maximum Incident Power in Passband	+10	dBm
Max. DC voltage between any 2 terminals	30	VDC
Storage Temperature Range	-40 to +85	°C
Max Soldering Profile	265°C for 10 s	

Electrical Characteristics

Characteristic	Sym	Notes	Min	Typ	Max	Units
Nominal Center Frequency	f_c	1	315.000			MHz
Passband	IL			13.0	14.0	dB
	BW_1	1, 2	± 2.1	± 2.25		MHz
Fast Amplitude Ripple over $f_c \pm 2.1$ MHz					1.0	dB _{P-P}
Group Delay Variation over $f_c \pm 2.1$ MHz	GDV			75	200	ns _{P-P}
Rejection		1, 2, 3	40	47		dB
Operating Temperature Range	T_A	1	-40		+85	°C
Differential Input and Output Impedance			250 ohms			
Case Style		6	SMP-03 7 x 5 mm Nominal Footprint			
Lid Symbolization (YY=year, WW=week, S=shift) See note 4			RFM SF1142B YYWWS			

Electrical Connections

Connection	Terminals
Port 1 Hot	10
Port 1 Ground Return	1
Port 2 Hot	5
Port 2 Ground Return	6
Case Ground	All Others

Notes:

1. Unless noted otherwise, all specifications apply over the operating temperature range with filter soldered to the specified demonstration board with impedance matching to 50 Ω and measured with 50 Ω network analyzer.
2. Unless noted otherwise, all frequency specifications are referenced to the nominal center frequency, f_c .
3. The design, manufacturing process, and specifications of this filter are subject to change.
4. Either Port 1 or Port 2 may be used for either input or output in the design. However, impedances and impedance matching may vary between Port 1 and Port 2, so that the filter must always be installed in one direction per the circuit design.
5. US and international patents may apply.
6. ©Copyright 1999, RF Monolithics Inc.
7. Electrostatic Sensitive Device. Observe precautions for handling

NOTES:

- 1 ~~SOLDER "TAPE" 4 PLACES ONTO COMPONENT SIDE OF PCB AS SHOWN.~~
- 2 USE A WRIST STRAP WHEN SOLDERING TRANS 1, AND TRANS 2 TO PCB.
(CUT LEADS .07 IN.)
- 3 MOUNT AND SOLDER ALL COMPONENTS ON PCB.
- 4 CUT CENTER CONDUCTORS FROM J1 AND J2 TO .10 IN.
- 5 MOUNT J1 AND J2 AS SHOWN (SOLDER BACKSIDE ALSO).
- 6 LABEL DEMO BOARD ACCORDINGLY.
- 7 MOUNT "FILTER" ON TOPSIDE OF PCB AS SHOWN.
- 8 MOUNT L1 AND L2 90° TO EACH OTHER.
- 9 ~~CUT SHIELD IN TWO PIECES, "SHIELD A" AND "SHIELD B".
SOLDER TO PCB AS SHOWN.~~

REV	ECN	DESCRIPTION	DATE
A	9121	INITIAL RELEASE	26oct00
B	10655	REVISED	30apr02
C	11077	REVISED	20nov02

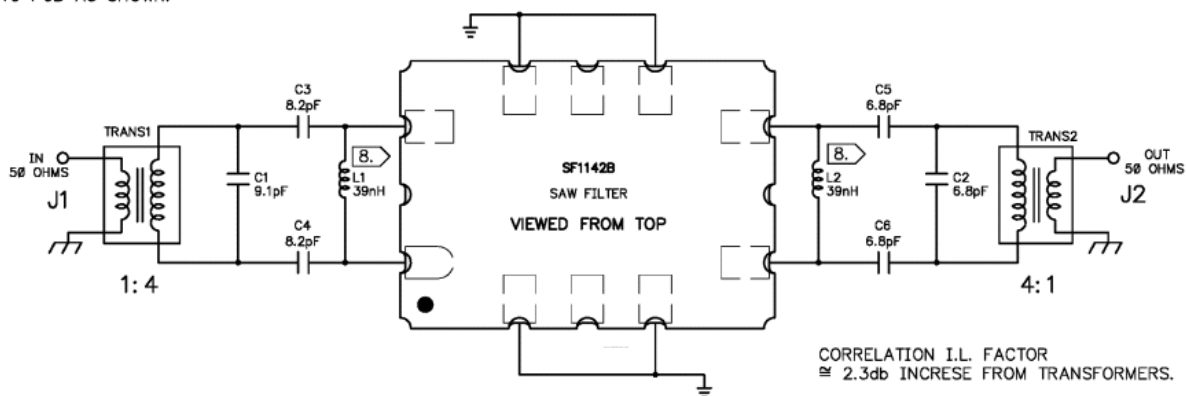

MATERIAL/FINISH:	UNLESS OTHERWISE SPECIFIED DIMENSIONS ARE IN INCHES(mm) DIMENSIONING AND TOLERANCING PER ANSI Y14.5-1982 DRAWING PREPARED IN ACCORDANCE WITH MIL-STD-100 LINEAR GENERAL TOLERANCING AS FOLLOWS: .XX = ±.01 .XXX = ±.005 .XXXX = ±.0010 ANGULAR = ±0°30'	DRAWN J.F.Christopherson	DATE 26oct00	RFMonolithics, Inc. DALLAS, TEXAS 75244 USA		
	GENERAL MACHINED SURFACE FINISH 63/	CHECKED/APPROVED	DATE		TITLE ASSY DIAGRAM, SF1142B-DEMO, S, TD	
		SIZE B	FSCM NO. 2U874	DWG. NO. SF1142B-100	REV C	SHEET 1/2

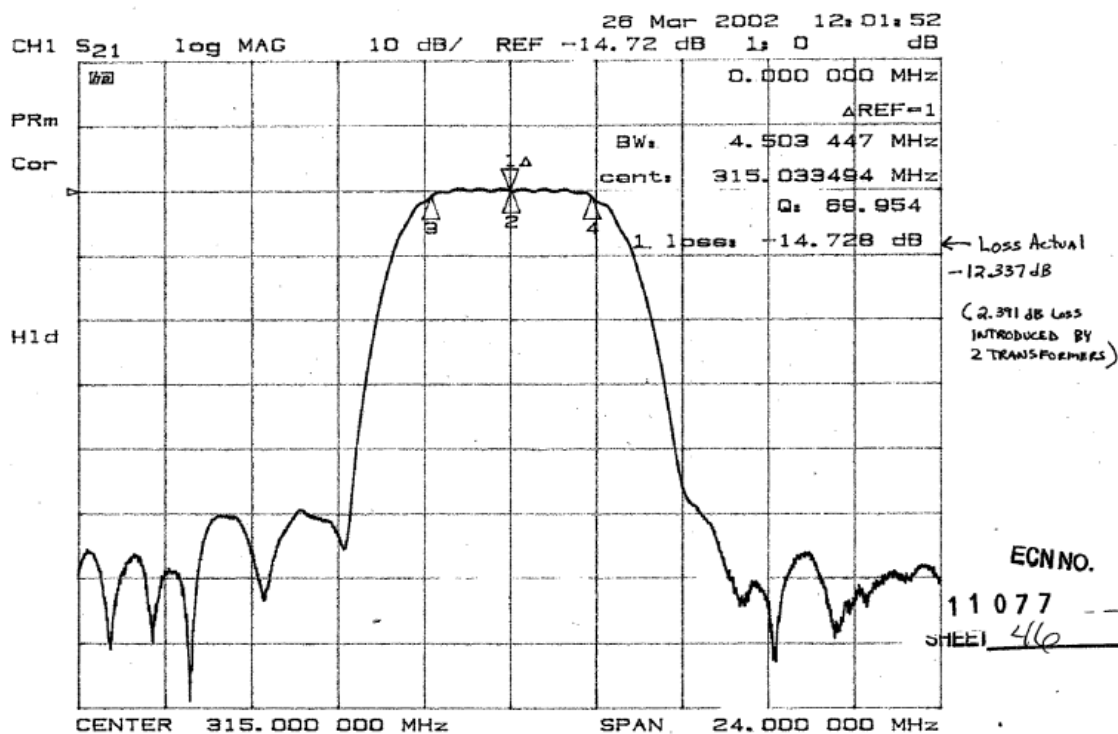
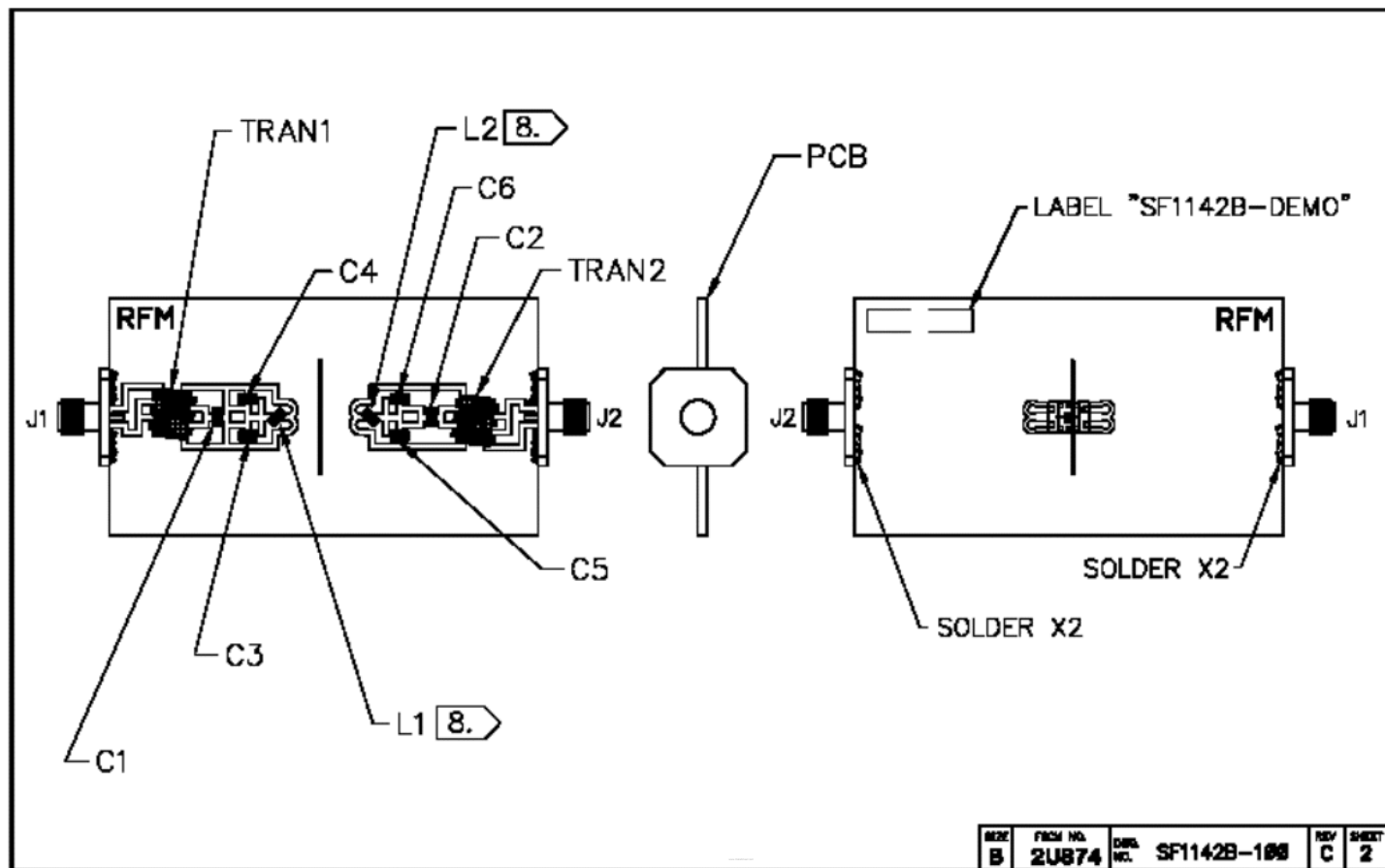

315.00 MHz

SAW Filter

26 Mar 2002 12:06:01
 CH1 S11 1 U FS 1: 39.736 Ω 13.131 Ω 8.6344 nH
 315.000 000 MHz

PRm
 Cor

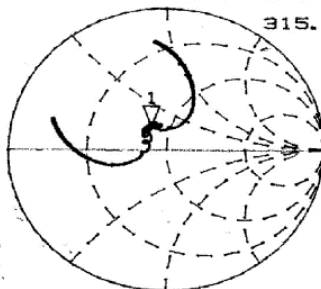

H1d

CH2 S22 1 U FS 1: 26.956 Ω 1.5781 Ω 797.35 pF
 315.000 000 MHz

PRm
 Cor

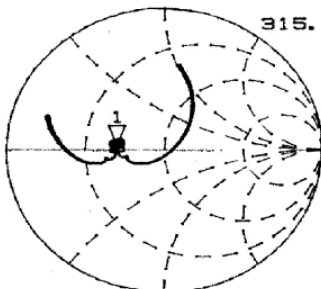

H1d

CENTER 315.000 000 MHz SPAN 24.000 000 MHz

ECN NO.
 11077
 SHEET 47

26 Mar 2002 11:56:40
 CH1 S21 delay 100 ns/ REF 850 ns 3: -10.133 ns

4.200 000 MHz
 Δ REF=2
 mean: 860.42 ns
 s. dev: 24.064 ns
 p-p: 98.904 ns

Smo
 H1d

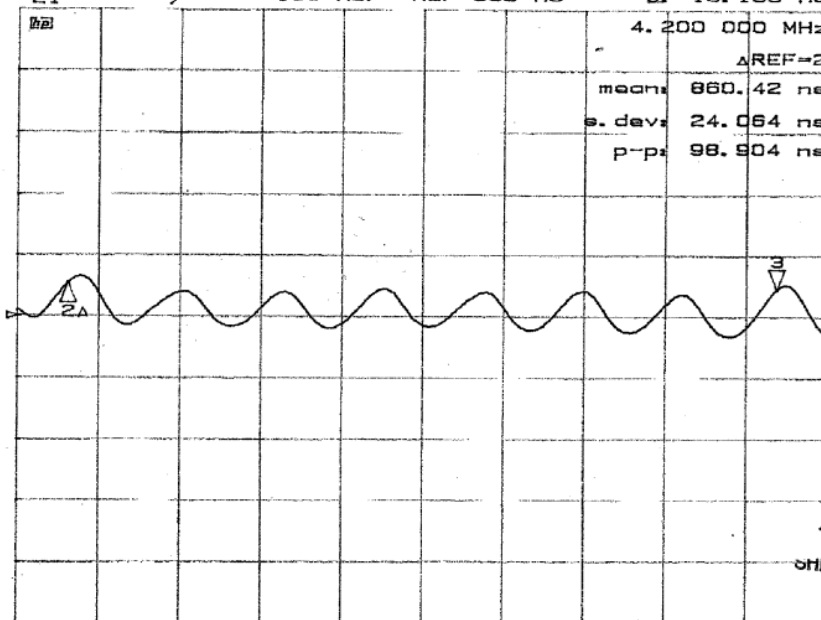

CENTER 315.000 000 MHz SPAN 4.800 000 MHz

ECN NO.
 11077
 SHEET 48

Tape and Reel Specifications

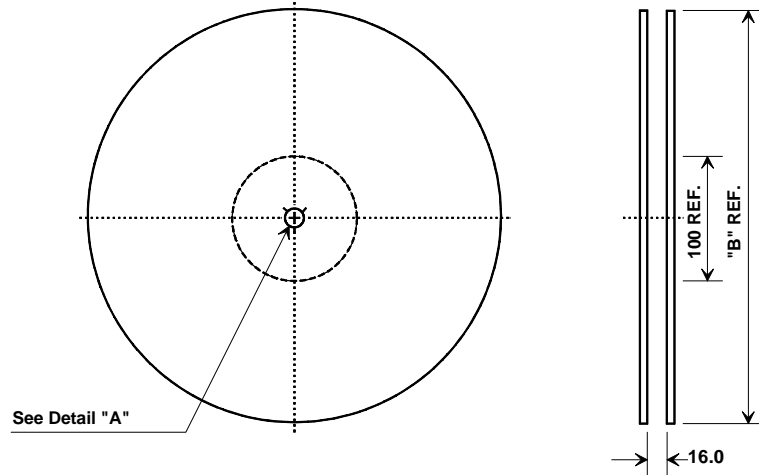

"B" Nominal Size		Quantity Per Reel
Inches	millimeters	
7	178	500
13	330	2000

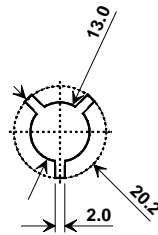

COMPONENT ORIENTATION and DIMENSIONS

Carrier Tape Dimensions		Tolerance
Ao	5.5 mm	± 0.1mm
Bo	7.5 mm	± 0.1mm
Ko	2.0 mm	± 0.1mm
Pitch	8.0 mm	± 0.1mm
W	16.0 mm	± 0.2mm

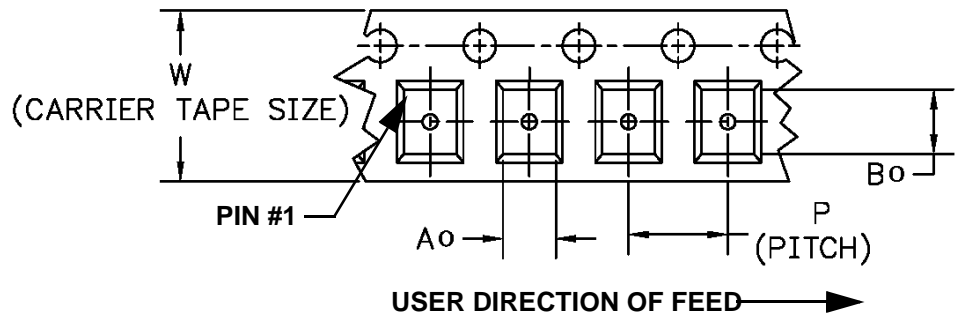
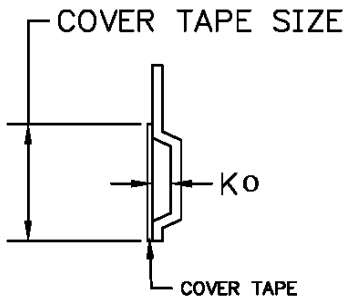

SMP-03 Case

10-Terminal Ceramic Surface-Mount Case 7 x 5 mm Nominal Footprint

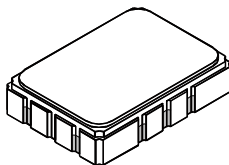

Recommended PCB Footprint

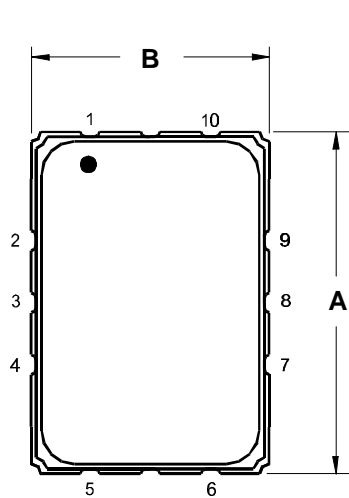
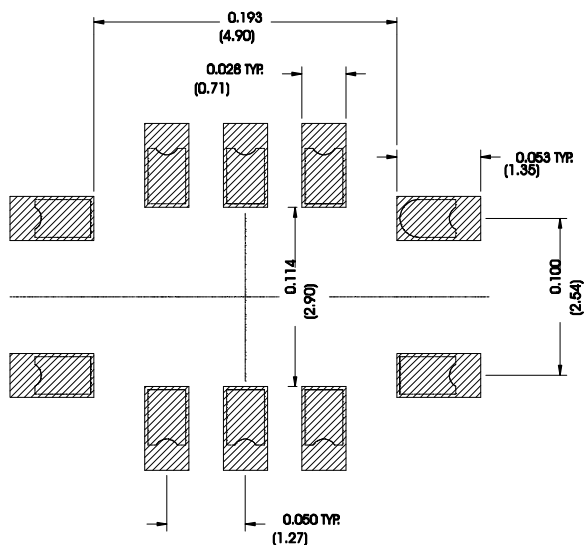

TOP VIEW

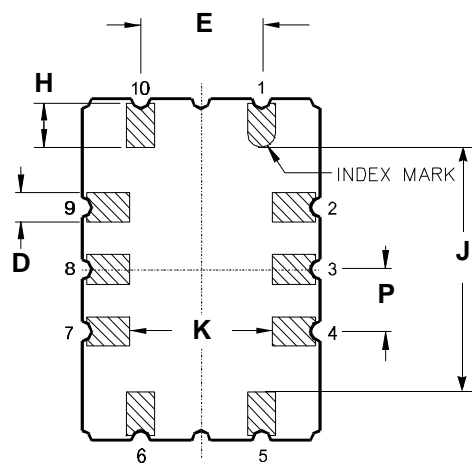
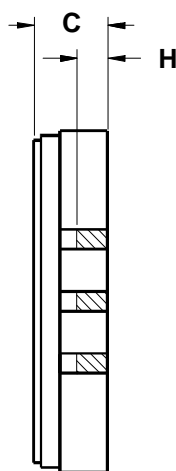

BOTTOM VIEW

Case Dimensions						
Dimension	mm			Inches		
	Min	Nom	Max	Min	Nom	Max
A	6.80	7.00	7.20	0.268	0.276	0.283
B	4.80	5.00	5.20	0.189	0.197	0.205
C		1.65	2.00		0.065	0.079
D	.47	0.60	.73	0.019	0.024	0.029
E	2.41	2.54	2.67	0.095	0.100	0.105
H	0.87	1.0	1.13	0.034	0.039	0.044
J	4.87	5.00	5.13	0.192	0.197	0.202
K	2.87	3.00	3.13	0.113	0.118	0.123
P	1.14	1.27	1.40	0.045	0.050	0.055

Materials	
Solder Pad Termination	Au plating 30 - 60 ulnches (76.2-152 uM) over 80-200 ulnches (203-508 uM) Ni.
Lid	Fe-Ni-Co Alloy Electroless Nickel Plate (8-11% Phosphorus) 100-200 ulnches Thick
Body	Al ₂ O ₃ Ceramic
Pb Free	

Electrical Connections		
Connection		Terminals
Port 1	Input or Return	10
	Return or Input	1
Port 2	Output or Return	5
	Return or Output	6
Ground		All others
Single Ended Operation		Return is ground
Differential Operation		Return is hot