

Preliminary

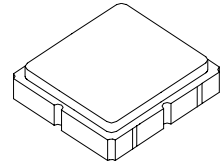

SF1186E-1

**1575.42 MHz
SAW Filter**



SM3030-6

- Low-loss GPS RF SAW Filter
- No Matching Required for 50 Ω Source/Load Impedances
- Complies with Directive 2002/95/EC (RoHS)



Absolute Maximum Ratings

Rating	Value	Units
Input Power Level	+10	dBm
DC Voltage on any Non-grounded Terminal	3	V
Operating Temperature Range	-40 to +85	°C
Storage Temperature Range in Tape and Reel	-40 to +85	°C
Storage Temperature Range of Filter	-50 to +100	°C
Maximum Soldering Profile, 5 cycles/10 seconds maximum	265	°C

Electrical Characteristics

Characteristic	Sym	Notes	Min	Typ	Max	Units
Center Frequency	f_c			1575.42		MHz
Insertion Loss, 1574.42 to 1576.42 MHz	IL			2.9	4.0	dB
Amplitude Ripple, 1574.42 to 1576.42 MHz				0.1	1.5	dB _{p-p}
Input/Output VSWR, 1574.42 to 1576.42 MHz				1.55:1	2.5:1	
Attenuation, Referenced to 0 dB:						dB
1 to 890 MHz			40	60		
890 to 1475 MHz			36	55		
1475.42 MHz			36	50		
1535.42 MHz			29	50		
1615.42 MHz			25	42		
1675.42 MHz			40	55		
1700 to 3000 MHz			25	38		
Source Impedance	Z_S			50		Ω
Load Impedance	Z_L			50		Ω
Case Style	SM3030-6 3.0 x 3.0 mm Nominal Footprint					
Lid Symbolization (Y=year, WW=week, S=shift) dot=pin 1 indicator	978, YWWS					
Standard Reel Quantity	Reel Size 7 inch					500 Pieces/Reel
	Reel Size 13 inch					3000 Pieces/Reel

Electrical Connections

Connection	Terminals
Input	2
Output	5
Case Ground	All others



CAUTION: Electrostatic Sensitive Device. Observe precautions for handling.

Notes:

1. Unless noted otherwise, all specifications apply over the operating temperature range with filter soldered to the specified demonstration board with impedance matching to 50 Ω and measured with 50 Ω network analyzer.
2. Unless noted otherwise, all frequency specifications are referenced to the nominal center frequency, f_c .
3. Rejection is measured as attenuation below the minimum IL point in the passband. Rejection in final user application is dependent on PCB layout and external impedance matching design. See Application Note No. 42 for details.
4. "LRIP" or "L" after the part number indicates "low rate initial production" and "ENG" or "E" indicates "engineering prototypes."
5. The design, manufacturing process, and specifications of this filter are subject to change.
6. Either Port 1 or Port 2 may be used for either input or output in the design. However, impedances and impedance matching may vary between Port 1 and Port 2, so that the filter must always be installed in one direction per the circuit design.
7. US and international patents may apply.
8. RFM, stylized RFM logo, and RF Monolithics, Inc., are registered trademarks of RF Monolithics, Inc.

Filter Passband Response

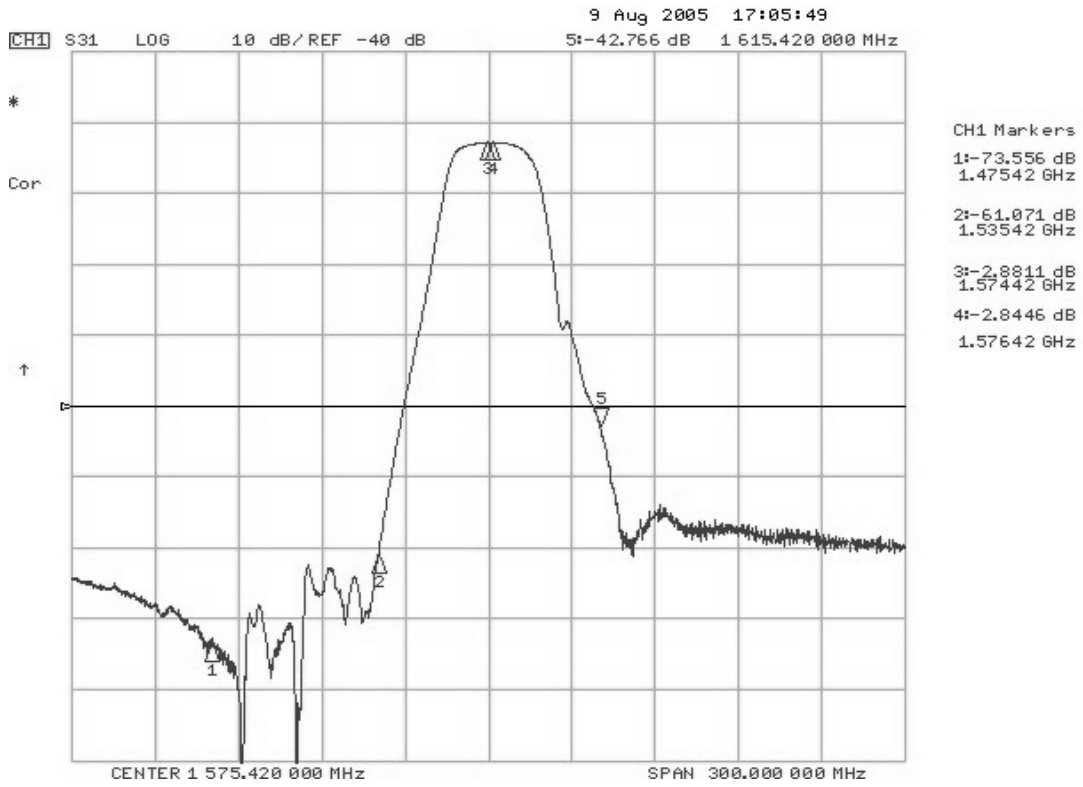

Filter Broadband Response

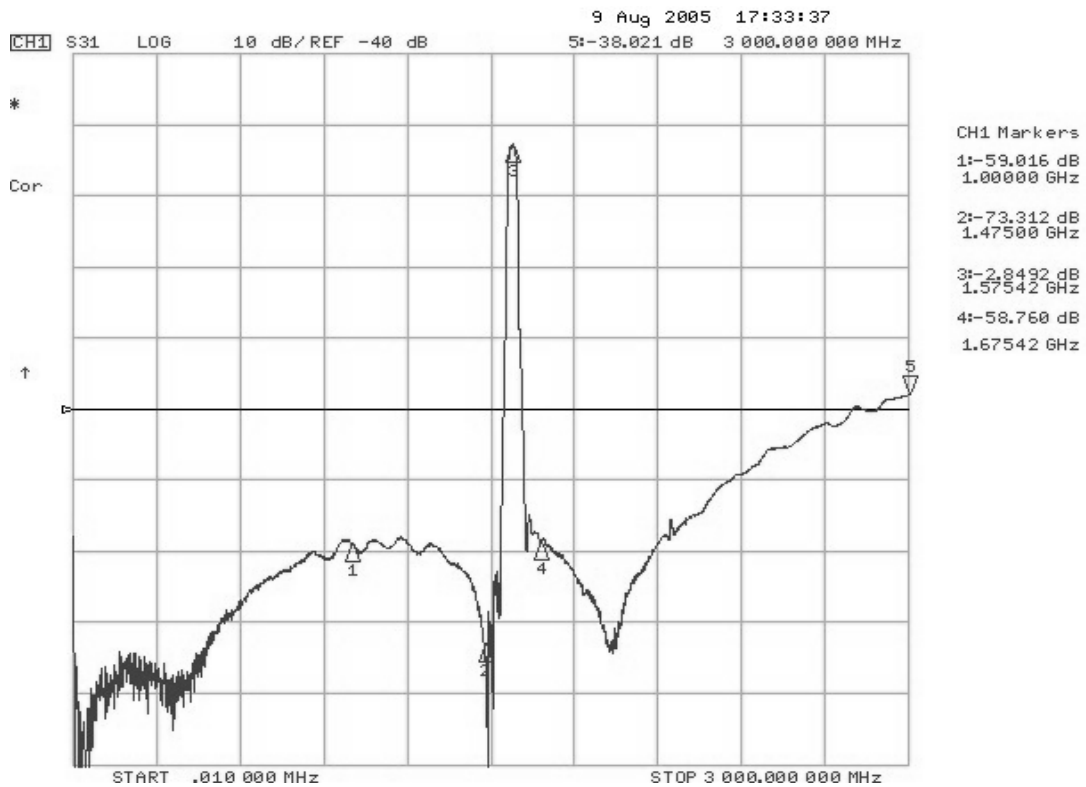

Filter Input SWR and Impedance

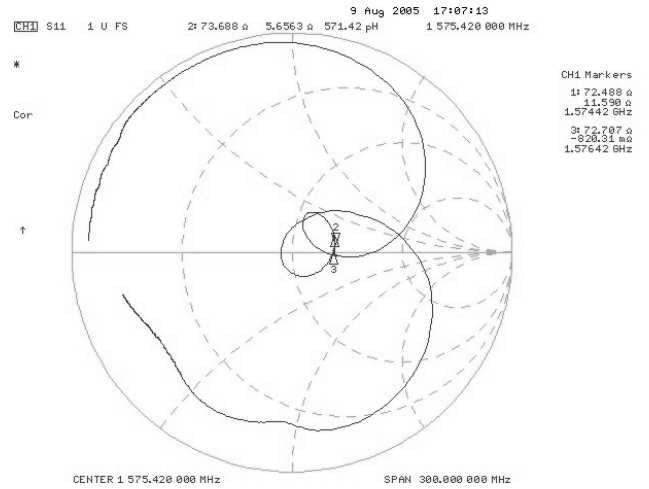
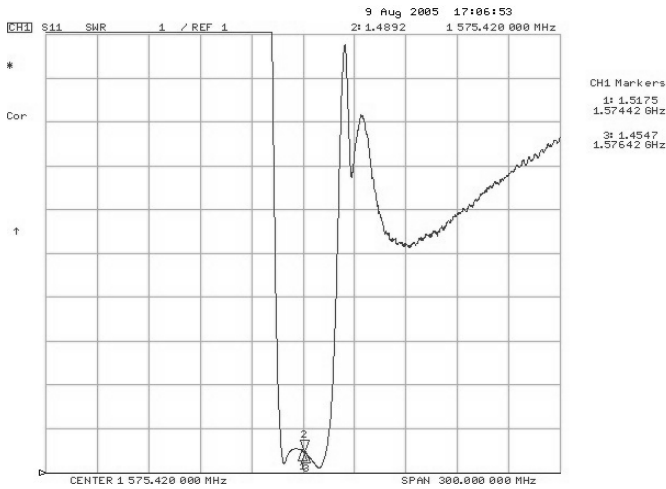

Filter Output SWR and Impedance

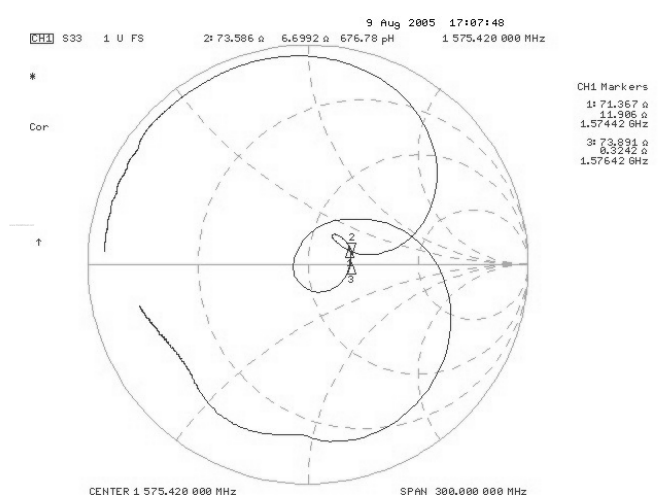
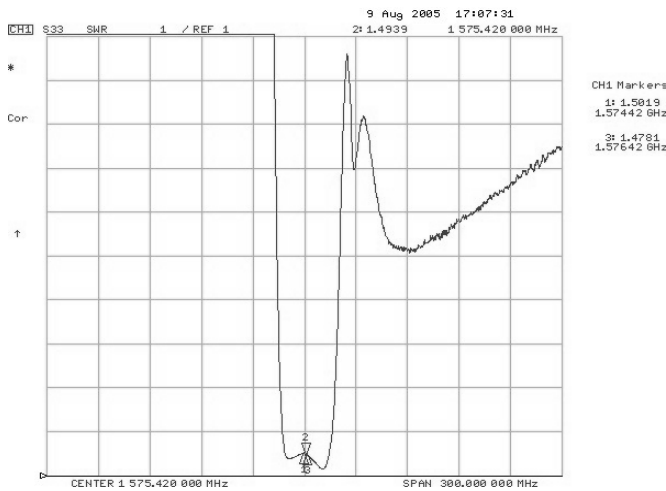

SM3030-6 Case

6-Terminal Ceramic Surface-Mount Case 3.0 X 3.0 mm Nominal Footprint

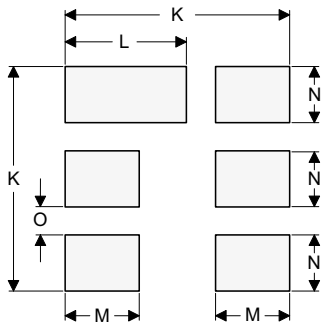
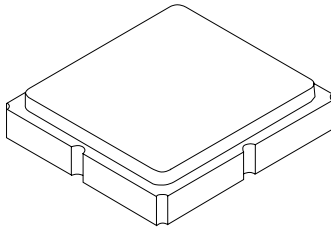

PCB Footprint Top View

Case and PCB Footprint Dimensions

Dimension	mm			Inches		
	Min	Nom	Max	Min	Nom	Max
A	2.87	3.00	3.13	0.113	0.118	0.123
B	2.87	3.00	3.13	0.113	0.118	0.123
C	1.12	1.25	1.38	0.044	0.049	0.054
D	0.77	0.90	1.03	0.030	0.035	0.040
E	2.67	2.80	2.93	0.105	0.110	0.115
F	1.47	1.60	1.73	0.058	0.063	0.068
G	0.72	0.85	0.98	0.028	0.033	0.038
H	1.37	1.50	1.63	0.054	0.059	0.064
I	0.47	0.60	0.73	0.019	0.024	0.029
J	1.17	1.30	1.43	0.046	0.051	0.056
K		3.20			0.126	
L		1.70			0.067	
M		1.05			0.041	
N		0.81			0.032	
O		0.38			0.015	

Case Materials

Materials	
Solder Pad Plating	0.3 to 1.0 μ m Gold over 1.27 to 8.89 μ m Nickel
Lid Plating	2.0 to 3.0 μ m Nickel
Body	Al ₂ O ₃ Ceramic
Pb Free	

TOP VIEW

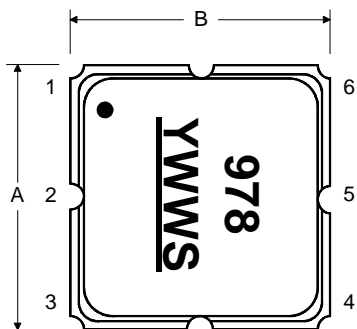

BOTTOM VIEW

