

Preliminary



- CDMA 450 F-Band RF SAW Filter
- 3.8 x 3.8 x 1.4 mm Surface-mount Package
- Complies with Directive 2002/95/EC (RoHS)



SF1214D

**413.7 MHz
SAW Filter**

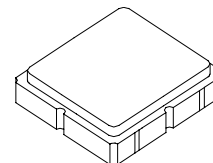

SM3838-6

Absolute Maximum Ratings

Rating	Value	Units
Maximum Incident Power in Passband	+30	dBm
Maximum DC Voltage between any Two Terminals	30	VDC
Storage Temperature Range	-40 to +85	°C
Suitable for Lead-free Soldering - Maximum Soldering Profile	260°C for 30 s	

Electrical Characteristics

Characteristic	Sym	Notes	Min	Typ	Max	Units
Nominal 1 dB Center Frequency	f_c	1		413.7		MHz
Passband Insertion Loss	411.6 to 415.9 MHz		IL		1.8	2.8
VSWR	411.6 to 415.9 MHz			1.5:1	2:1	
Rejection	0.3 to 400.0 MHz	1, 2, 3	25	27		dB
	421.6 to 425.9 MHz		30	50		
	425.9 to 1700 MHz		23	27		
	1700 to 2000 MHz		18	21		
Operating Temperature Range	T_A	1	-30		+80	°C
Impedance at f_c	Source, single ended		50 ohm			
	Load, single ended		50 ohm			
Case Style	SM3838-6 3.8 x 3.8 mm Nominal Footprint					
Lid Symbolization (Y=year, WW=week, S=shift) dot=pin 1 indicator	643, YWWS					
Standard Reel Quantity	Reel Size 7 Inch	1000 Pieces/Reel				
	Reel Size 13 Inch	3000 Pieces/Reel				

Electrical Connections

Connection	Terminals
Port 1	2
Port 2	5
Case Ground	All others

 **CAUTION: Electrostatic Sensitive Device. Observe precautions for handling.**

Notes:

1. Unless noted otherwise, all specifications apply over the operating temperature range with filter soldered to the specified demonstration board with impedance matching to 50 Ω and measured with 50 Ω network analyzer.
2. Unless noted otherwise, all frequency specifications are referenced to the nominal center frequency, f_c .
3. Rejection is measured as attenuation below the minimum IL point in the passband. Rejection in final user application is dependent on PCB layout and external impedance matching design. See Application Note No. 42 for details.
4. "LRIP" or "L" after the part number indicates "low rate initial production" and "ENG" or "E" indicates "engineering prototypes."
5. The design, manufacturing process, and specifications of this filter are subject to change.
6. Either Port 1 or Port 2 may be used for either input or output in the design. However, impedances and impedance matching may vary between Port 1 and Port 2, so that the filter must always be installed in one direction per the circuit design.
7. US and international patents may apply.
8. RFM, stylized RFM logo, and RF Monolithics, Inc. are registered trademarks of RF Monolithics, Inc.

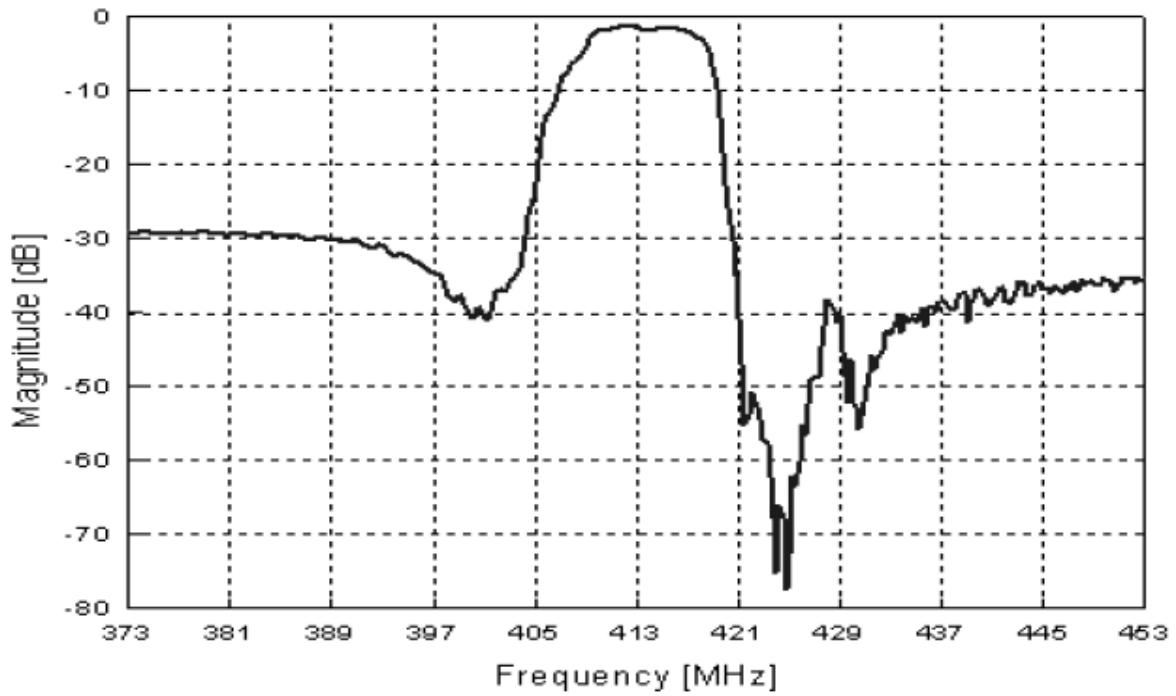

Passband Plot

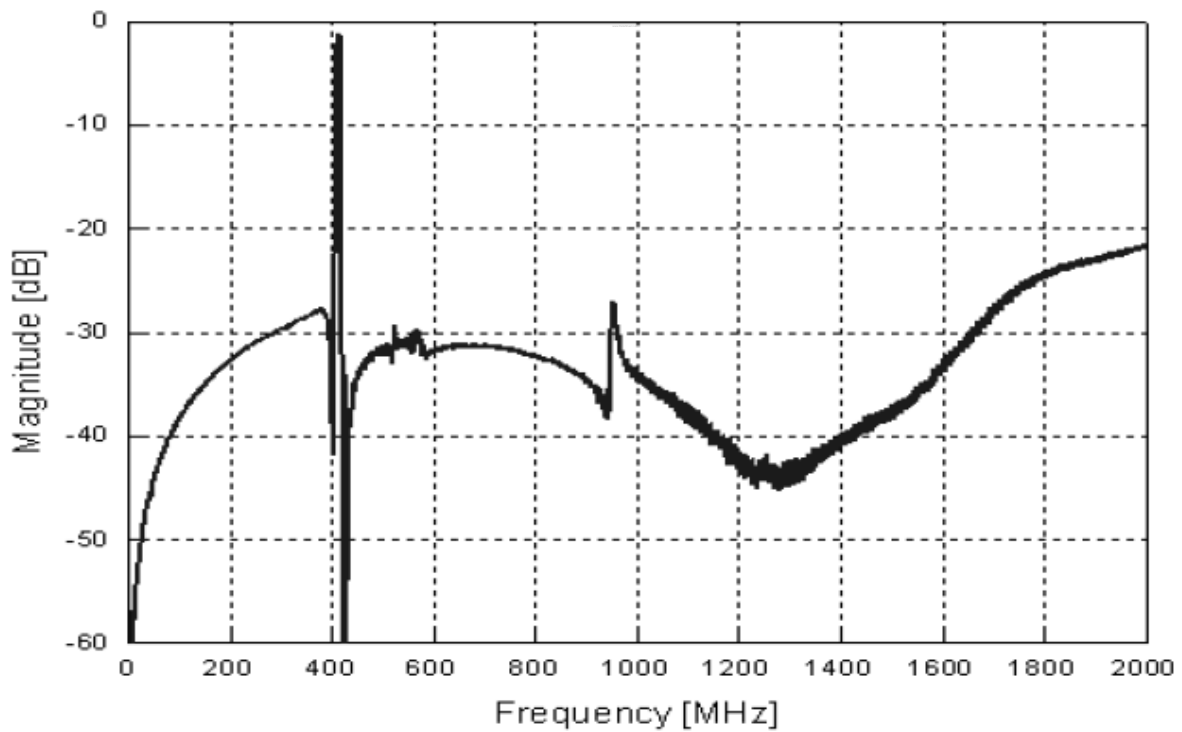

Wideband Plot

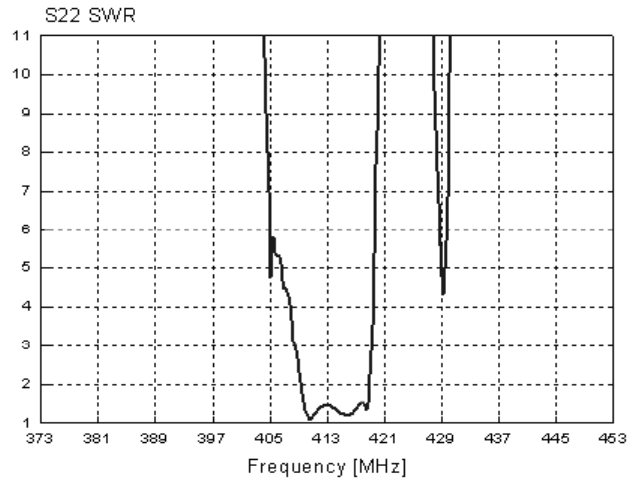
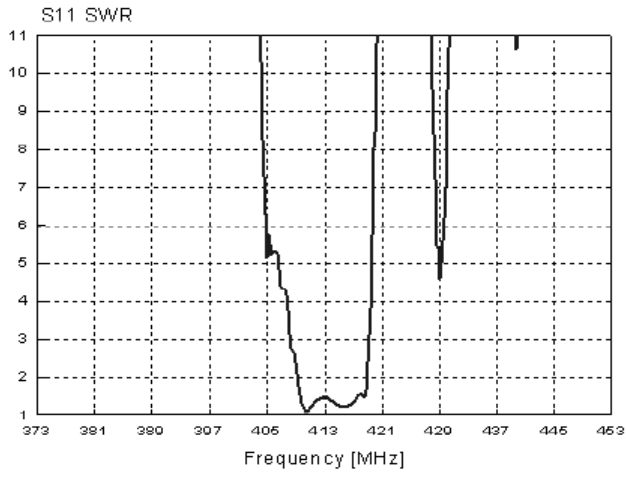

VSWR

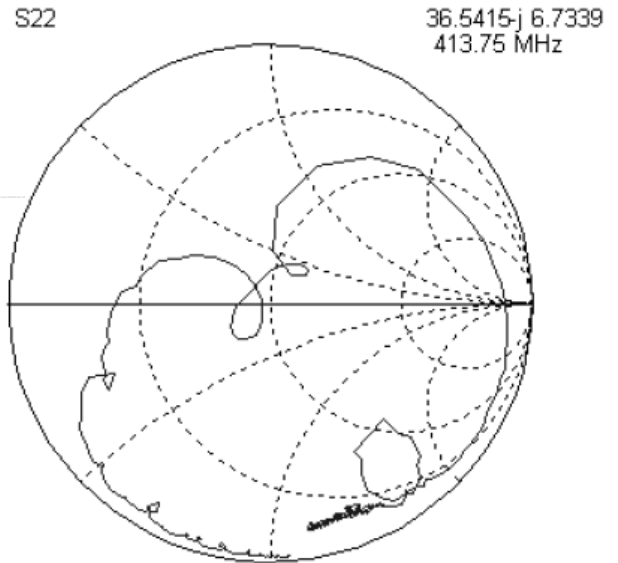
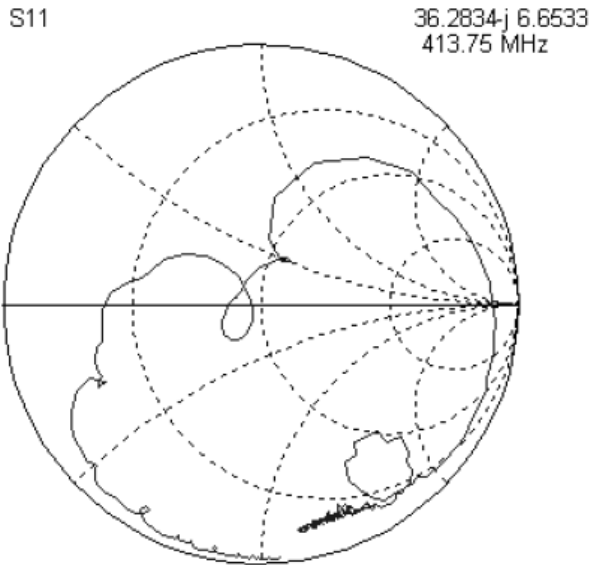

S11 and S22 Plots

Tape and Reel Specifications

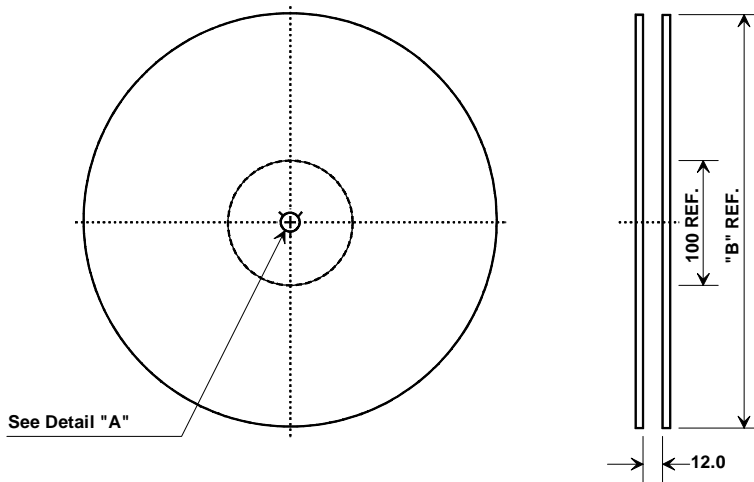

"B" Nominal Size		Quantity Per Reel
Inches	millimeters	
7	178	1000
13	330	3000

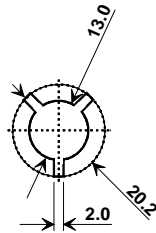

COMPONENT ORIENTATION and DIMENSIONS

Carrier Tape Dimensions	
Ao	4.25 mm
Bo	4.25 mm
Ko	1.30 mm
Pitch	8.0 mm
W	12.0 mm

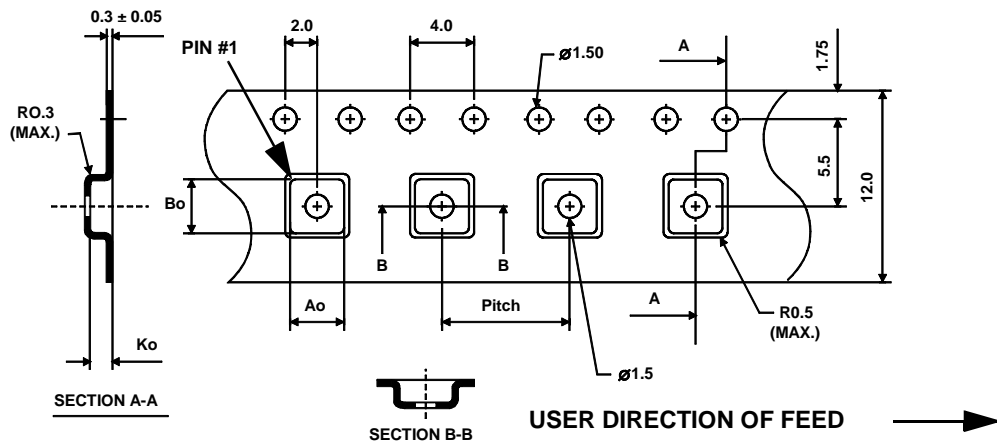

SM3838-6 Case

6-Terminal Ceramic Surface-Mount Case

3.8 X 3.8 mm Nominal Footprint

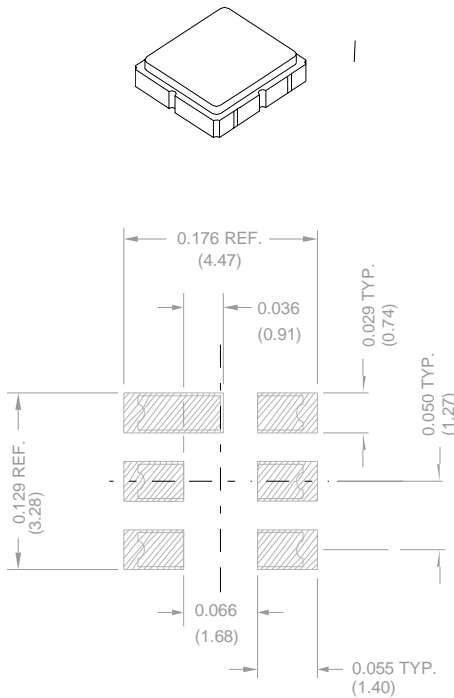

PCB Footprint

Case Dimensions						
Dimension	mm			Inches		
	Min	Nom	Max	Min	Nom	Max
A	3.60	3.80	4.0	0.14	0.15	0.16
B	3.60	3.80	4.0	0.14	0.15	0.16
C	1.30	1.50	1.70	0.05	0.06	0.067
D	0.95	1.10	1.25	0.037	0.043	0.05
E	2.39	2.54	2.69	0.090	0.10	0.110
G	0.90	1.0	1.10	0.035	0.04	0.043
H	1.90	2.0	2.10	0.75	0.08	0.83
I	0.50	0.6	0.70	0.020	0.024	0.028
J	1.70	1.8	1.90	0.067	0.07	0.075

Electrical Connections		
Connection	Terminals	
Port 1	Single Ended Input	2
Port 2	Single Ended Output	5
	Ground	All others
Single Ended Operation Only		
Dot indicates Pin 1		

Materials	
Solder Pad Termination	Au plating 30 - 60 μ inches (76.2-152 μ m) over 80-200 μ inches (203-508 μ m) Ni.
Lid	Fe-Ni-Co Alloy Electroless Nickel Plate (8-11% Phosphorus) 100-200 μ inches Thick
Body	Al ₂ O ₃ Ceramic
Pb Free	

TOP VIEW

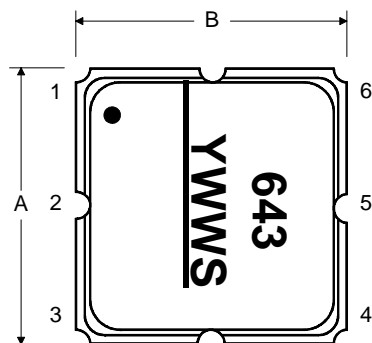

BOTTOM VIEW

