

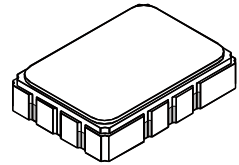

SF2046B

**456.44 MHz
SAW Filter**

- **Designed for 802.16 and WIMAX Receiver IF Application**
- **Low Insertion Loss**
- **5.0 X 7.0 mm Surface-Mount Case**
- **Differential Input and Output**
- **Complies with Directive 2002/95/EC (RoHS)** 



SMP-03

Absolute Maximum Ratings

Rating	Value	Units
Maximum Incident Power in Passband	+13	dBm
Max. DC voltage between any 2 terminals	30	VDC
Storage Temperature Range	-40 to +85	°C
Suitable for lead-free soldering - Max Soldering Profile	260°C for 30 s	

Electrical Characteristics

Characteristic	Sym	Notes	Min	Typ	Max	Units
Nominal Center Frequency	f_c	1		456.44		MHz
Insertion Loss				8.0	9.1	dB
Bandwidth, 2dB			5.22	6.0		MHz
Rejection 3 dB Bandwidth nominal, specify 40 dB min, Frequency lower 40 dB min, Frequency upper Bandwidth, 40 dB min (Ultimate Rejection)			449.09	6.5		MHz
				13.0	464.79	
				108	315	
Group Delay (Across 1 dB frequencies)				1.0	2.5	dBpk-pk
Amplitude Ripple (Across 453.83 to 459.05) -15 to +85°C				1.0	3.9	dB
Amplitude Ripple (Across 453.83 to 459.05) -40 to -15						
Reflected Wave Signal Suppression 1 usec after main pulse 2 usec after main pulse 3 usec after main pulse			20			
			30			
			40			
				200		Ohms
Input Impedance (Differential)				200		Ohms
Output Impedance (Differential)						
Temperature	Operating		-40		85	°C
	Storage		-40		85	
Case Style	SMP-03 7 x 5 mm Nominal Footprint					
Lid Symbolization (YY=year, WW=week, S=shift, ##=sequence code) See note 4	RFM SF2046B YYWWS##					

Notes:

1. Unless noted otherwise, all specifications apply over the operating temperature range with filter soldered to the specified demonstration board with impedance matching to 50 Ω and measured with 50 Ω network analyzer.
2. Unless noted otherwise, all frequency specifications are referenced to the nominal center frequency, f_c .
3. "LRIP" or "L" after the part number indicates "low rate initial production" and "ENG" or "E" indicates "engineering prototypes."
4. The design, manufacturing process, and specifications of this filter are subject to change.
5. Either Port 1 or Port 2 may be used for either input or output in the design. However, impedances and impedance matching may vary between Port 1 and Port 2, so that the filter must always be installed in one direction per the circuit design.
6. US and international patents may apply.
7. RFM, stylized RFM logo, and RF Monolithics, Inc. are registered trademarks of RF Monolithics, Inc.
8. ©Copyright 1999, RF Monolithics Inc.
9. Electrostatic Sensitive Device. Observe precautions for handling. 

SMP-03 Case

10-Terminal Ceramic Surface-Mount Case 7 x 5 mm Nominal Footprint

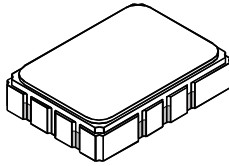

Recommended PCB Footprint

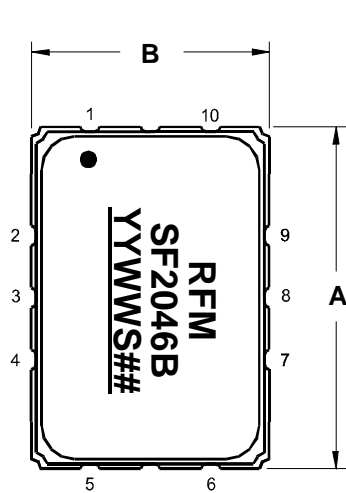
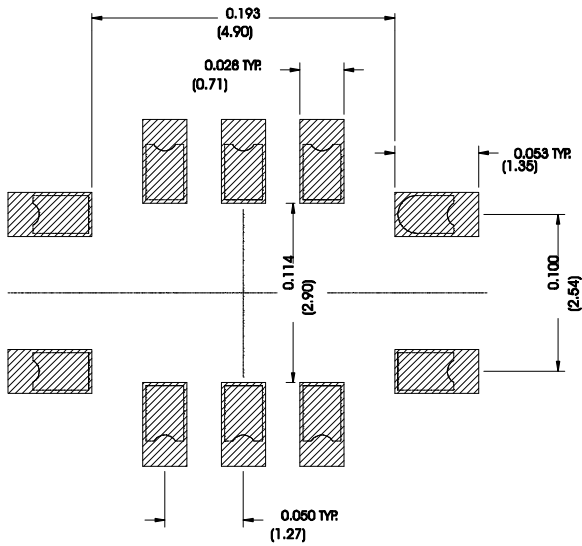

TOP VIEW

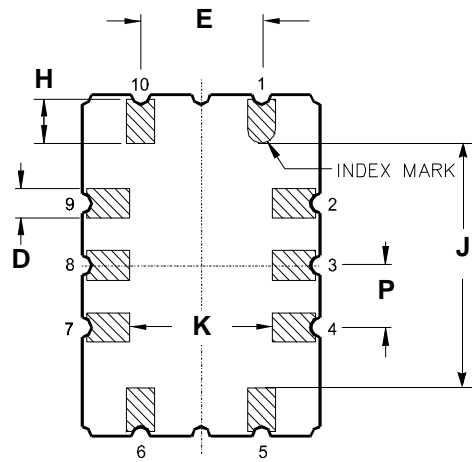
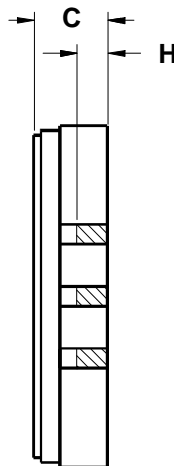

BOTTOM VIEW

Case Dimensions

Dimension	mm			Inches		
	Min	Nom	Max	Min	Nom	Max
A	6.80	7.00	7.20	0.268	0.276	0.283
B	4.80	5.00	5.20	0.189	0.197	0.205
C		1.65	2.00		0.065	0.079
D	.47	0.60	.73	0.019	0.024	0.029
E	2.41	2.54	2.67	0.095	0.100	0.105
H	0.87	1.0	1.13	0.034	0.039	0.044
J	4.87	5.00	5.13	0.192	0.197	0.202
K	2.87	3.00	3.13	0.113	0.118	0.123
P	1.14	1.27	1.40	0.045	0.050	0.055

Materials

Solder Pad Termination	Au plating 30 - 60 ulnches (76.2-152 uM) over 80-200 ulnches (203-508 uM) Ni.
Lid	Fe-Ni-Co Alloy Electroless Nickel Plate (8-11% Phosphorus) 100-200 ulnches Thick
Body	Al ₂ O ₃ Ceramic
Pb Free	

Electrical Connections

Connection		Terminals
Port 1	Input or Return	10
	Return or Input	1
Port 2	Output or Return	5
	Return or Output	6
Ground		All others
Single Ended Operation		Return is ground
Differential Operation		Return is hot

Tape and Reel Specifications

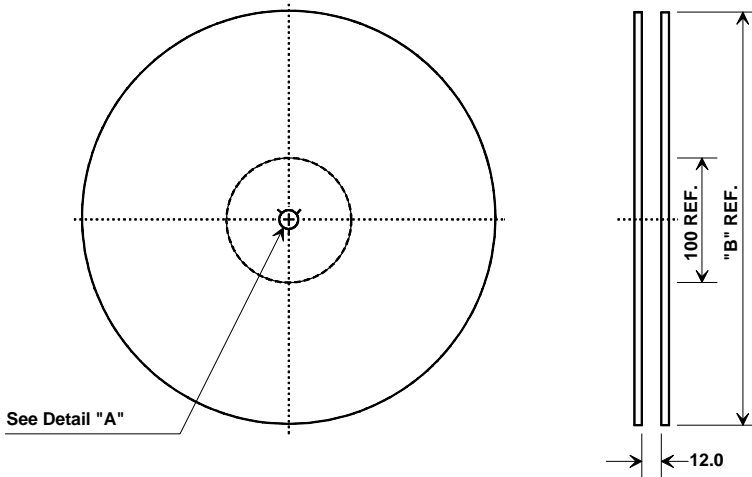

"B" Nominal Size		Quantity Per Reel
Inches	millimeters	
7	178	500
13	330	2000

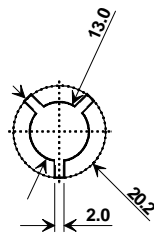

COMPONENT ORIENTATION and DIMENSIONS

Carrier Tape Dimensions	
Ao	9.4 mm
Bo	7.4 mm
Ko	2.0 mm
Pitch	8.0 mm
W	16.0 mm

