



SF2069A-2

- Low Insertion Loss
- Hermetic 13.3 x 6.5 mm Surface-mount Case
- Complies with Directive 2002/95/EC (RoHS)



**96.0 MHz
SAW Filter**

Absolute Maximum Ratings

Rating	Value	Units
Maximum Incident Power in Passband	+10	dBm
Max. DC voltage between any 2 terminals	30	VDC
Storage Temperature Range	-40 to +85	°C
Max. Soldering Profile	265°C for 10 s	

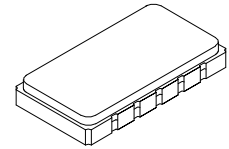

SMP53-S

Electrical Characteristics

Characteristic	Sym	Notes	Min	Typ	Max	Units
Center Frequency (@ 25°C)	f _c	1	95.9	96.0	96.1	MHz
Minimum Insertion Loss				14	15	dB
1 dB Bandwidth			5.00	5.60		MHz
15 dB Bandwidth				7.50	8.00	MHz
Passband Variation (in 1dB Bandwidth)				0.5	1.0	dB p-p
Phase Linearity (Fc ±1.92 MHz)				5.2	8	deg p-p
Group Delay Variation (in 1 dB Bandwidth)				50	80	ns p-p
Absolute Delay				1.4	3	us
Change in Absolute Delay (from unit to unit)			-10	0	10	ns
Absolute Delay Variation (from -40°C to 55°C)				8	15	ns
Rejection (40 to 87 MHz)			43	48		dB
Rejection (111 to 150 MHz)			43	48		dB
Source and Load Impedance				50		Ω
Temperature Coefficient				-20		ppm/°C
Ambient Temperature				25		°C

Case Style	SMP-53-S 13.3 x 6.5 mm Nominal Footprint
Lid Symbolization (YY = year, WW = week, D=day)	RFM SF2069A-2 YYWWD

Electrical Connections

Connection	Terminals
Port 1 Input	1
Port 2 Output	6
Case Ground	2, 3, 4, 5, 7, 8, 9,10



CAUTION: Electrostatic Sensitive Device. Observe precautions for handling.

Notes:

1. Unless noted otherwise, all specifications apply over the operating temperature range with filter soldered to the specified demonstration board with impedance matching to 50 Ω and measured with 50 Ω network analyzer.
2. Unless noted otherwise, all frequency specifications are referenced to the nominal center frequency, f_c.
3. Rejection is measured as attenuation from f_c IL. Rejection in final user application is dependent on PCB layout and external impedance matching design. See Application Note No. 42 for details.
4. Part to part absolute delay measurement records the absolute delay mean across 2 dB passband.
5. "LRIP" or "L" after the part number indicates "low rate initial production" and "ENG" or "E" indicates "engineering prototypes."
6. The design, manufacturing process, and specifications of this filter are subject to change.
7. Either Port 1 or Port 2 may be used for either input or output in the design. However, impedances and impedance matching may vary between Port 1 and Port 2, so that the filter must always be installed in one direction per the circuit design.
8. US and international patents may apply.

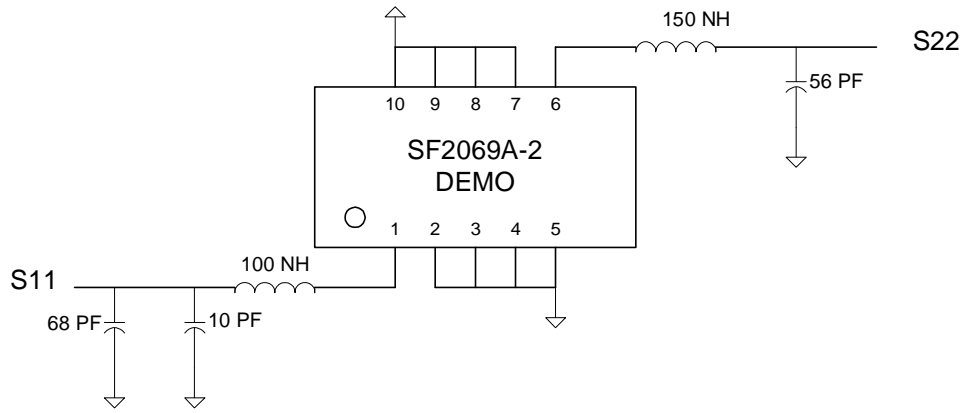

IND,	1008, 100NH	501-0782-101	L1
IND,	1008, 150NH	501-0782-151	L2
CAP,	0805, 68PF	501-1275-680	C1
CAP,	0805, 10PF	501-1275-100	C2
CAP,	0805, 56PF	501-1275-560	C3

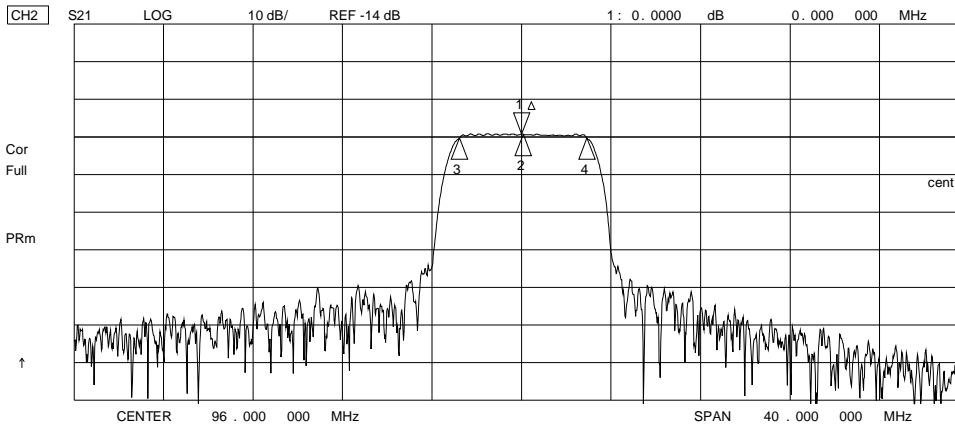
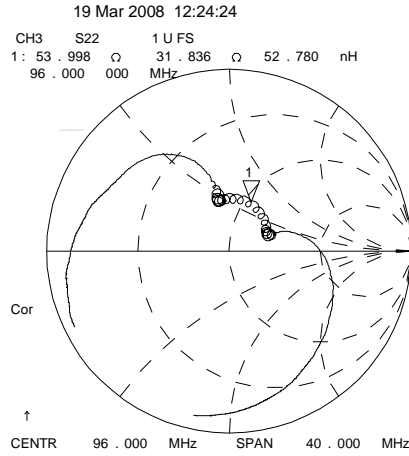
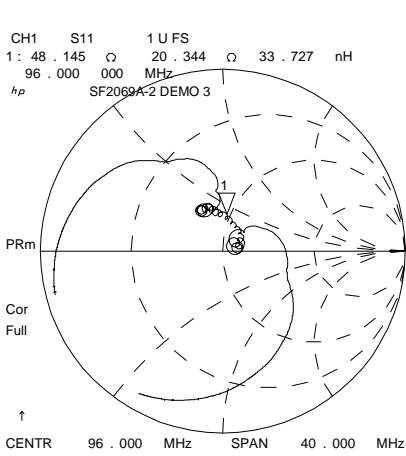

CH2 Markers
△ REF=1
BW: 5.700334 MHz
cent: 96.069100 MHz
Q: 16.853
1_loss: -13.343 dB

19 Mar 2008 12:24:37

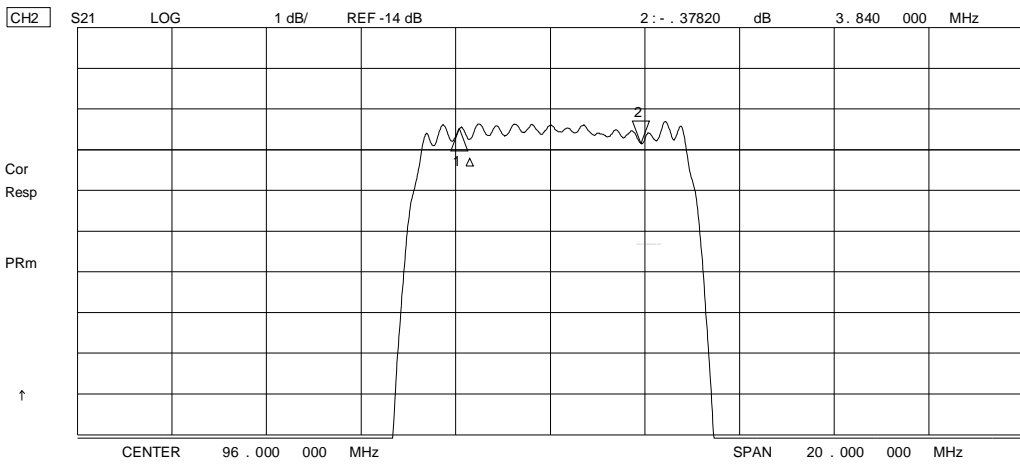
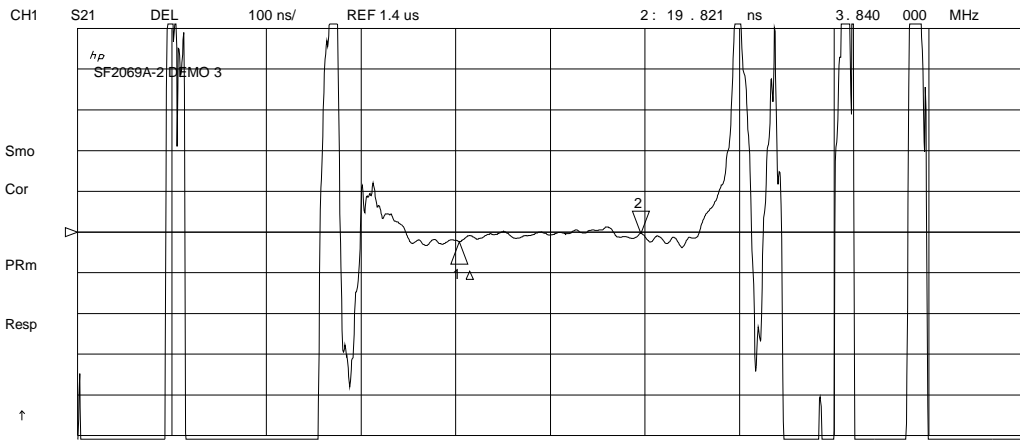

SMP-53-S Case

10-Terminal Ceramic Surface-Mount Case 13.3 x 6.5 mm Nominal Footprint

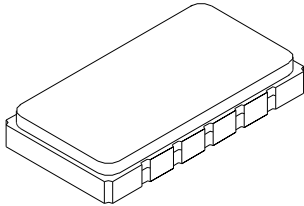

Case Dimensions

Dimension	mm			Inches		
	Min	Nom	Max	Min	Nom	Max
A		13.3			.524	
B		6.5			.256	
C			2.00			.078
D		2.3			.091	
E		1.91			.075	
F		1.02			.040	
G		1.0			0.039	

Electrical Connections

Connection	Terminals
Port 1 Hot	1
Port 1 Gnd Return	10
Port 2 Hot	6
Port 2 Gnd Return	5
Case Ground	All others
Single Ended Operation	Return is ground
Differential Operation	Return is hot

